

Tools that will be needed for this installation are:

- Cordless drill with #2 Robertson or Phillips bit
- 2' to 4' level
- 7/16" wrench

Carefully unpackage your shutter. **NOTE: DO NOT THROW OUT ANY PACKAGING MATERIAL UNTIL THE INSTALLATION IS COMPLETE AND YOU ARE SURE THAT YOU HAVE FOUND ALL OF THE COMPONENTS SENT WITH THE SHUTTER.** When you have your shutter unpackaged you should have the following components: (see **Figure A** below)

- Shutter box with curtain rolled inside of it
- 2 guide rails with extenders
- 1 installation kit which contains the installation instructions and the hardware for installing your shutter



Figure A

IMPORTANT NOTE

- THE LEGS ON THE END CAPS CAN BREAK. YOU MUST TAKE CARE NOT TO PUT UNDUE PRESSURE ON THESE LEGS DURING THE INSTALLATION.



The following instructions are meant as a guide to installing your shutter. They cannot cover all applications. You are responsible to use safe work procedures to prevent injury to yourself and others and to prevent damage to the shutter. If you encounter a problem or have a question please contact Technical Support at the number provided at the end of these instructions.

1. Determine where the shutter is going to mount onto the filing cabinet. Make sure that there is a flat, even surface to mount the shutter to and that the clamps provided in the installation package will work to attach the guide rail extenders to the shelving post.
2. Remove the protective plastic coating from the outside of the shutter box (see **Figure B**).



Figure B

OPTION 1- NO HEADROOM

3. Lay the shutter on its top or on its back and slide the guide rails onto the end cap legs as shown in the following pictures. The end of the guide rail that is 985mm (38.75") from the bottom of the plunge lock is the bottom. The extender on the guide rail is to be on Side A of the shutter (the side with the coil box) (see **Figure C & D**).

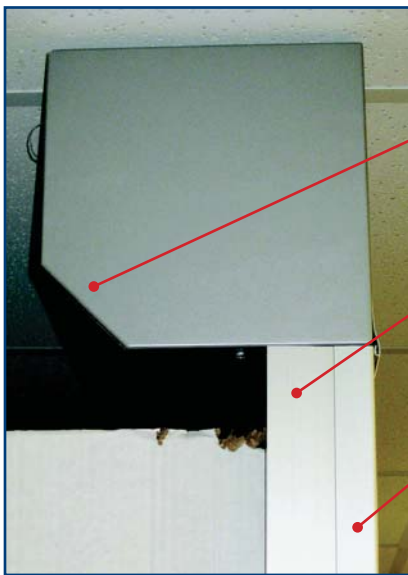

Figure C

SIDE A/
COIL SIDE

GUIDE RAIL
EXTENDER

GUIDE RAIL



Figure D

4. With two people, turn the shutter over 180 degrees and place the extenders of the guide rails against the post of the filing shelf with the box over the top of the filing cabinet (See **Figure E & F**). **MAKE SURE THAT THE SHUTTER BOX IS SUPPORTED WHERE IT JOINS THE GUIDE RAILS WHILE MOVING AS THE END CAP LEGS CAN BREAK.**



Figure E

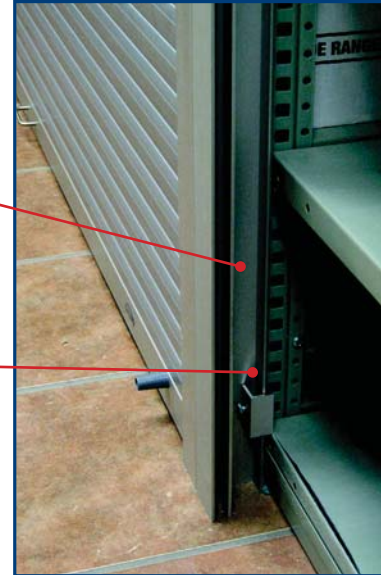

Figure F

5. Use your level to make sure that the guide rails are straight and level. Use the clamps provided to secure the guide rail extender on the shutter to the shelving post (see **Figure G**). The bolt on the clamp should be facing the guide rail so that it doesn't interfere with the file storage.

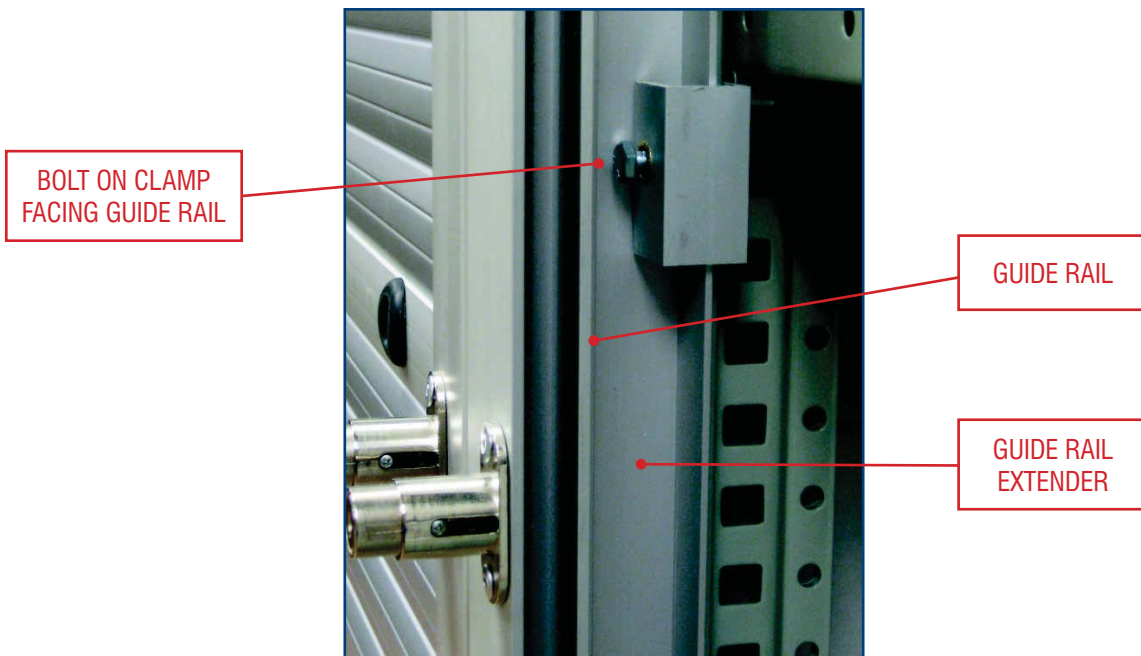
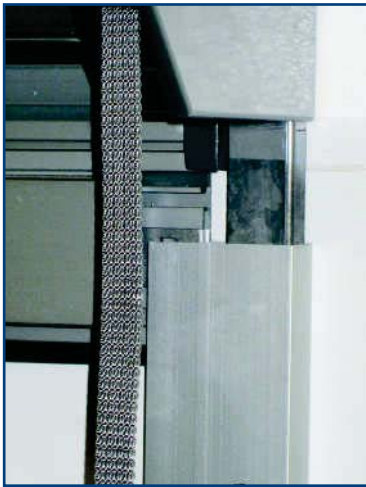

Figure G

OPTION 2 - 12" OF HEADROOM

- I. Stand the guide rail up against the post on the shelving unit with the guide rail extenders against the shelving unit post (see **Figure E & F**). The end of the guide rail that is 985mm (38.75") from the bottom of the plunge lock is the bottom.
- II. Use your level to make sure that the guide rails are straight and level. Use the clamps provided to secure the guide rail extenders to the shelving post (see **Figure G** above). The bolt on the clamp should be facing the guide rail so that it doesn't interfere with the file storage.
- III. Position the shutter box above the guide rails and slide the end cap legs down into the outside channel of the guide rails (see **Figure H**).

**Figure H**

FASTEN SUPPORT
BAR TO BOX AT THIS
LOCATIONS

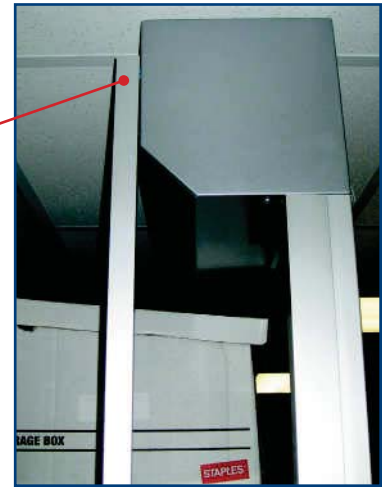
**Figure I**

6. If your shutter is electric operated, provide power to the motor using a plug or a test cord, following the attached wiring diagram.
7. Shutters wider than 6' are provided with box supports to support the box and keep the end cap leg from breaking. Put the bottom on the top of the file cabinet and secure the top to the front of the shutter box through the holes provided (see **Figure I**).
8. Carefully roll the curtain of the shutter down to the closed position and remove the protective foam.
9. Test the operation of your shutter and make sure that it locks correctly.
10. For electric operated shutters, follow the attached limit setting instructions to set the open and closed stop limits.

KEY SWITCH CONTROL SPECIFICATIONS

FEATURES



- Single gang standard. Narrow style and double gang models available
- standard mortise cylinders, "1 – 1 1/4"
- Heavy duty 1/4" thick aluminum plate
- 1 piece die cast construction
- Locators prevent cylinder from spinning
- No set screws required
- Vandal resistant
- Left and/or right operation
- Momentary operation
- UL/CSA approved switches
- Indoor or outdoor applications
- Tamper proof screws provided
- Cylinder sits flush to faceplate
- Fast & easy to install
- Casted centre rib protects switches from damage
- Brushed aluminum finish
- Custom colour finishes & engraving available

DESCRIPTION

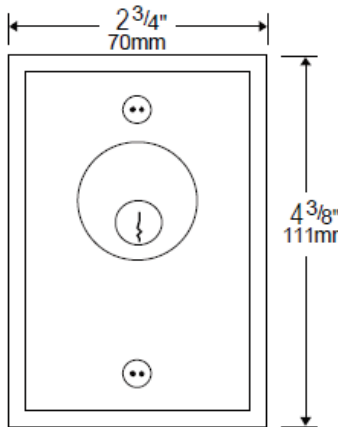

Pentagon recessed and surface mount key switches meet the stringent demands of key switch controls. They are designed for use with standard 1", 1 1/8" or 1 1/4" mortise cylinders. These switches are fabricated from 1/4" thick aluminum, in a one piece die cast construction.

Standard is a single gang (2 3/4") width. Also available is a double gang model. Both models accept one or two switches, and have a counter sunk cylinder opening, in a one piece casted assembly. A brass cylinder with Schlage keyway, a brass cylinder lock ring, socket/slotted screws, and 2 tamperproof screws are also supplied. The design and construction makes it ideal for all weather environments. The assembly is tamper and vandal resistant.

Pentagon Key Switches are flexible and can accept numerous types of mortise cylinders to suit varied commercial and industrial applications and functions. Pentagon Key Switches provide a practical, cost effective means for authorized personnel to control and signal various functions within a complex.

APPLICATION

Pentagon Key Switches will control rolling shutters, grilles, screens and overhead doors which require both an up and a down command. They are constructed for high frequency use, and will accept any standard mortise cylinder.

CAST ALUMINUM KEY SWITCH CONTROLS

ARCHITECTS / ENGINEERS SPECIFICATONS

Pentagon Key switch controls are available in both a recessed (flush) mount and surface mount with weather and vandal proof cast aluminum box and rubber weather seal.

The faceplate will incorporate a mounting platform for both the cylinder and switches, in a single piece construction. The faceplate will have 180° locators so that set screws shall not be required to prevent the cylinders from rotating. Only a brass cylinder lock ring will be employed to hold the mortise cylinder to the faceplate. The one piece 1/4" thick aluminum assembly shall be tamper and vandal resistant, with a countersunk cylinder opening and the edges beveled. The key switch shall be supplied with stainless steel Torx or snake eye security screws.

The one piece faceplate with casted mounting platform will have two holes for switch mounting. It shall be possible to select either left or right operation. In areas requiring dual control, two switches shall be used offering bi-directional operation from the same key switch.

The switch used will be a UL/CSA approved type, rated for 6A/125V AC, and 3A/250V AC. The switch must be protected from accidental damage from the cylinder cam, by having an integral metal centre rib incorporated into the design of the faceplate.

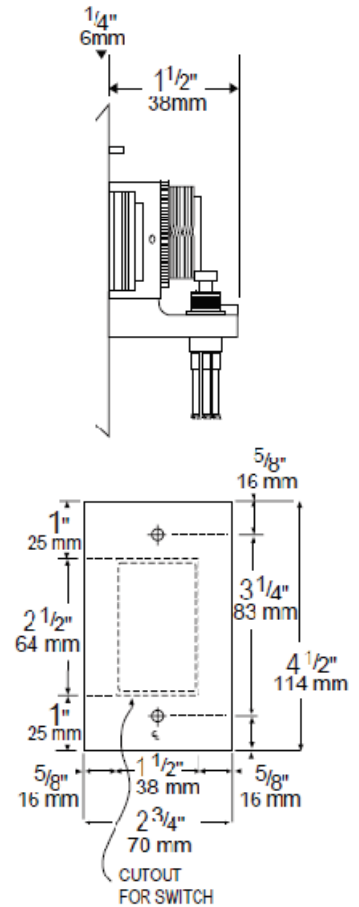

ORDERING INFORMATION

Pentagon Recessed Key switches are supplied with a brushed aluminum cast faceplate, brass key cylinder with Schlage keyway, brass cylinder lock ring, 2 socket/slotted screws and 2 tamperproof screws with a bit for the tamper proof screws.

Pentagon Surface Key Switches are supplied with a brushed aluminum cast faceplate, cast aluminum electrical box, rubber weather seal, brass key cylinder with Schlage keyway, brass cylinder lock ring, 4 socket/slotted screws and 4 tamper proof screws with a bit for the tamper proof screws.

For orders with multiple key switches, the cylinders can be ordered keyed alike.

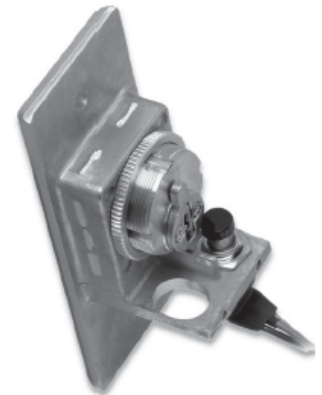

MODEL	DESCRIPTION
ER	Recessed Key Switch
ES	Surface Key Switch

Wiring Diagram for Key Switch

NOTICE: For installation by a qualified electrician in accordance with national and local electrical codes, and the following instructions.

CAUTION: Risk of electrical shock. Disconnect power before installing. Never wire energized components.



WARNING

DO NOT wire more than one operator to a single pole switch without an isolation control.

DO NOT connect more than one switch to an operator without an isolation control.

If your application requires more than one switch for each motor, or you want to control more than one motor with one switch, refer to isolation control instruction sheet.

The motor warranty is subject to cancellation if the above instructions are not followed.

PRECAUTIONS: Select conductors having 90°C or higher rated insulation having sufficient ampacity in accordance with the 60°C column of National Electric Code Table 310-16 or Canadian Electric Code Table 2.

- DO NOT USE TIN CONDUCTORS

Power from Source	
120VAC	Black
Neutral	White
Ground	Green

Motor Leads	
Direction 1	Red
Direction 2	Black
Neutral	White
Motor Ground	Green
Shutter Ground	LG Green

