

"R" Heavy-Duty Modular Cabinet

"R" CABINET



"R" HEAVY-DUTY MODULAR CABINET



R5AEE-5803

The heavy-duty cabinet, designed for intensive use, present the perfect fit to better respond to our customers needs. It is distinguished by the vast array of dimensions offered, accessories and its perfect modularity, but most of all by its durability.

The Rousseau cabinet comes in 5 different widths, each offered in different depths, for a total of 11 combinations, each available in 6 heights. Add to that the 10 drawer heights, and you have an incredible choice of possibilities. You're guaranteed to find the right size for your specific application.

Tested by an independent laboratory, the Rousseau cabinet proved to be the most durable on the market. The trials proved just how superior our drawer is. This allows us to be 100% confident in offering you a lifetime warranty on the drawer rolling mechanism.

The unique shape of the "R" drawer is a Rousseau Metal Inc. trademark and we own a design patent on the "R" drawer.

The Rousseau cabinet, in addition to being sturdy, offers a refined and unique look, which will stand the test of time. A shining example of unwavering durability.

"R" Heavy-Duty Modular Cabinet

"R" CABINET

The Rousseau Advantages



Sturdy and distinct appearance that works in all sorts of different environments.



10 drawer heights and 7 drawer side heights are available.



True North American dimensions which allow for perfect modularity.



Housings with pre-determined fixing zones for installation of accessories : work surfaces, shelves, etc.



400 lb capacity per drawer. The most heavy-duty in the industry.

General Dimensions

Available Heights

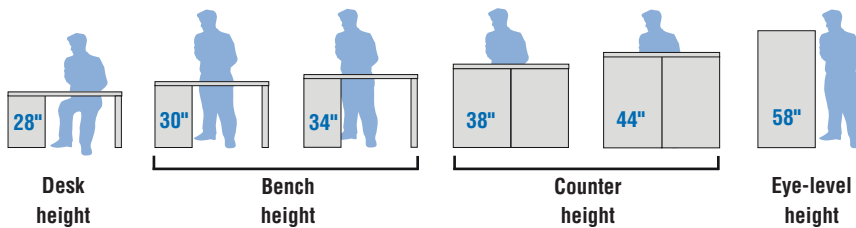

Width x Depth

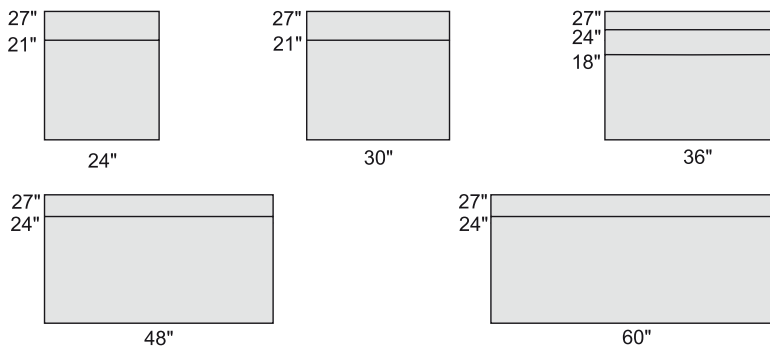

Index	Page(s)
"R" Heavy-Duty Modular Cabinet	4 - 5
Proposals	6 - 9
Accessories	10 - 17
Components	18 - 20
"L" Compact Cabinet	21
Proposals - Cabinets	22 - 23
Proposals - Drawer compartments	24 - 25
Accessories	26 - 27
Components	28 - 29

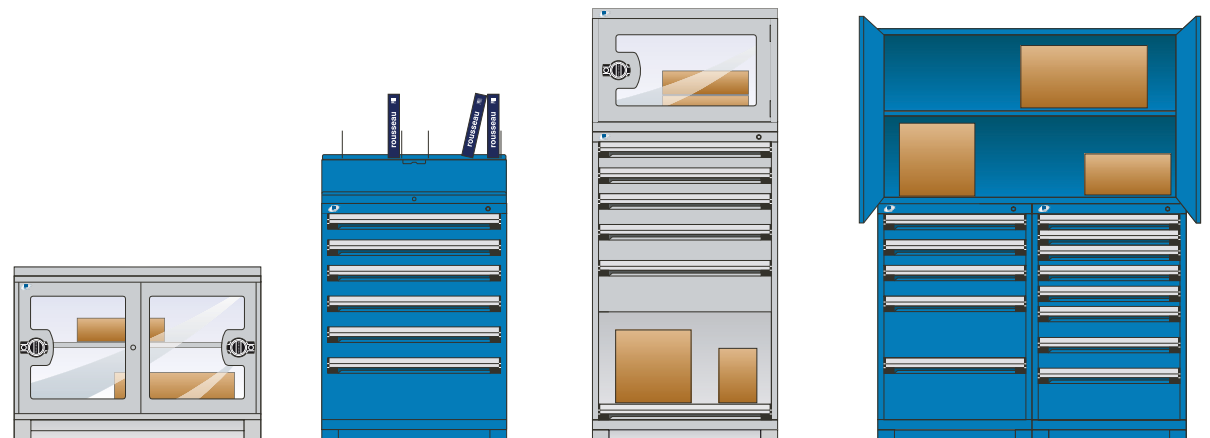

Proposals

"R" CABINET

Shown here are several of the more popular heavy-duty modular cabinet models.

All proposals include a 2" front-access forklift base and a lock on the cabinet housing (for models with more than one drawer) or on the door.

Doors are factory installed with hinges on the right side. They may be installed on the left side, upon request.



IMPORTANT *Drawer partitions are included in models.*

See number of compartments and proposed layouts on the following page.

NOTE

For drawers without partitioning, complete the even number following the last two digits of the model.

Ex. : R5ACD-2801 with R5ACD-2802 without

24" Wide

<p>4 drawers R5ACD-2801 24" x 21" x 30" R5ACG-2801 24" x 27" x 30"</p>	<p>3 drawers R5ACD-2803 24" x 21" x 30" R5ACG-2803 24" x 27" x 30"</p>	<p>4 drawers R5ACD-2805 24" x 21" x 30" R5ACG-2805 24" x 27" x 30"</p>	<p>6 drawers R5ACD-3001 24" x 21" x 32" R5ACG-3001 24" x 27" x 32"</p>	<p>4 drawers R5ACD-3005 24" x 21" x 32" R5ACG-3005 24" x 27" x 32"</p>
<p>1 door / 1 adjustable shelf / 1 bottom shelf R5ACD-3009 24" x 21" x 32" R5ACG-3009 24" x 27" x 32"</p>	<p>3 drawers R5ACD-3401 24" x 21" x 36" R5ACG-3401 24" x 27" x 36"</p>	<p>5 drawers R5ACD-3403 24" x 21" x 36" R5ACG-3403 24" x 27" x 36"</p>	<p>9 drawers R5ACD-3805 24" x 21" x 40" R5ACG-3805 24" x 27" x 40"</p>	<p>5 drawers R5ACD-3807 24" x 21" x 40" R5ACG-3807 24" x 27" x 40"</p>

30" Wide

<p>5 drawers R5ADD-2801 30" x 21" x 30" R5ADG-2801 30" x 27" x 30"</p>	<p>4 drawers R5ADD-2803 30" x 21" x 30" R5ADG-2803 30" x 27" x 30"</p>	<p>5 drawers R5ADD-2805 30" x 21" x 30" R5ADG-2805 30" x 27" x 30"</p>	<p>5 drawers R5ADD-3003 30" x 21" x 32" R5ADG-3003 30" x 27" x 32"</p>	<p>6 drawers R5ADD-3007 30" x 21" x 32" R5ADG-3007 30" x 27" x 32"</p>
<p>1 drawer / 1 door / 1 bottom shelf R5ADD-3009 30" x 21" x 32" R5ADG-3009 30" x 27" x 32"</p>	<p>7 drawers R5ADD-3801 30" x 21" x 40" R5ADG-3801 30" x 27" x 40"</p>	<p>7 drawers R5ADD-3803 30" x 21" x 40" R5ADG-3803 30" x 27" x 40"</p>	<p>8 drawers R5ADD-4401 30" x 21" x 46" R5ADG-4401 30" x 27" x 46"</p>	<p>8 drawers R5ADD-4407 30" x 21" x 46" R5ADG-4407 30" x 27" x 46"</p>

Number of Compartments (layout code)										
Drawer dimensions	24" x 21"	24" x 27"	30" x 21"	30" x 27"	36" x 18"	36" x 24"	48" x 24"	48" x 27"	60" x 24"	60" x 27"
3" to 5"	12 (0308)	20 (0316)	24 (0518)	25 (0420)	24 (0518)	30 (0524)	40 (0732)	32 (0724)	70 (1356)	84 (1370)
6" to 8"	9 (0206)	12 (0209)	12 (0308)	12 (0308)	8 (0304)	12 (0308)	15 (0410)	15 (0410)	24 (0716)	21 (0614)
9" and higher	4 (0102)	6 (0104)	6 (0203)	9 (0206)	6 (0203)	9 (0206)	8 (0304)	8 (0304)	12 (0308)	12 (0308)

NOTE For inside drawer dimensions.

SEE PAGES 134-135



9 drawers

R5ADD-5805	30" x 21" x 60"
R5ADG-5805	30" x 27" x 60"



9 drawers

R5ADD-5809	30" x 21" x 60"
R5ADG-5809	30" x 27" x 60"



9 drawers / 1 roll-out shelf

R5ADD-5811	30" x 21" x 60"
R5ADG-5811	30" x 27" x 60"



9 drawers

R5ADD-5813	30" x 21" x 60"
R5ADG-5813	30" x 27" x 60"



6 drawers / 1 door / 1 bottom shelf

R5ADD-5819	30" x 21" x 60"
R5ADG-5819	30" x 27" x 60"

36" Wide



4 drawers

R5AEC-2801	36" x 18" x 30"
R5AEE-2801	36" x 24" x 30"



4 drawers

R5AEC-2803	36" x 18" x 30"
R5AEE-2803	36" x 24" x 30"



5 drawers

R5AEC-3005	36" x 18" x 32"
R5AEE-3005	36" x 24" x 32"



5 drawers

R5AEC-3011	36" x 18" x 32"
R5AEE-3011	36" x 24" x 32"



5 drawers

R5AEC-3805	36" x 18" x 40"
R5AEE-3805	36" x 24" x 40"



5 drawers

R5AEC-3807	36" x 18" x 40"
R5AEE-3807	36" x 24" x 40"



7 drawers

R5AEC-4403	36" x 18" x 46"
R5AEE-4403	36" x 24" x 46"



11 drawers

R5AEC-4405	36" x 18" x 46"
R5AEE-4405	36" x 24" x 46"



Double door / 1 adjustable shelf / 1 bottom shelf

R5AEC-4412	36" x 18" x 46"
R5AEE-4412	36" x 24" x 46"



8 drawers

R5AEC-4413	36" x 18" x 46"
R5AEE-4413	36" x 24" x 46"

Proposals

"R" CABINET



11 drawers
 R5AEC-5803 36" x 18" x 60"
 R5AEE-5803 36" x 24" x 60"



9 drawers
 R5AEC-5813 36" x 18" x 60"
 R5AEE-5813 36" x 24" x 60"



14 drawers
 R5AEC-5817 36" x 18" x 60"
 R5AEE-5817 36" x 24" x 60"



8 drawers
 R5AEC-5825 36" x 18" x 60"
 R5AEE-5825 36" x 24" x 60"



7 drawers
 R5AEC-5833 36" x 18" x 60"
 R5AEE-5833 36" x 24" x 60"

48" Wide



5 drawers
 R5AHE-3003 48" x 24" x 32"
 R5AHG-3003 48" x 27" x 32"



7 drawers
 R5AHE-3801 48" x 24" x 40"
 R5AHG-3801 48" x 27" x 40"



1 sliding door / 1 adjustable shelf /
 1 bottom shelf
 R5AHE-3803 48" x 24" x 40"
 R5AHG-3803 48" x 27" x 40"



Double door / 1 adjustable shelf /
 1 bottom shelf
 R5AHE-3806 48" x 24" x 40"
 R5AHG-3806 48" x 27" x 40"



9 drawers
 R5AHE-4405 48" x 24" x 46"
 R5AHG-4405 48" x 27" x 46"



7 drawers
 R5AHE-4407 48" x 24" x 46"
 R5AHG-4407 48" x 27" x 46"



Double door / 1 adjustable shelf /
 1 bottom shelf
 R5AHE-4414 48" x 24" x 46"
 R5AHG-4414 48" x 27" x 46"



1 sliding door / 1 adjustable shelf /
 1 bottom shelf
 R5AHE-4416 48" x 24" x 46"
 R5AHG-4416 48" x 27" x 46"



15 drawers
 R5AHE-5805 48" x 24" x 60"
 R5AHG-5805 48" x 27" x 60"



6 drawers
 R5AHE-5807 48" x 24" x 60"
 R5AHG-5807 48" x 27" x 60"



8 drawers
 R5AHE-5809 48" x 24" x 60"
 R5AHG-5809 48" x 27" x 60"



9 drawers
 R5AHE-5813 48" x 24" x 60"
 R5AHG-5813 48" x 27" x 60"

60" Wide



Double door / 1 adjustable shelf / 1 bottom shelf

R5AKE-3802	60" x 24" x 40"
R5AKG-3802	60" x 27" x 40"



1 sliding door / 1 adjustable shelf / 1 bottom shelf

R5AKE-3804	60" x 24" x 40"
R5AKG-3804	60" x 27" x 40"



6 drawers

R5AKE-4401	60" x 24" x 46"
R5AKG-4401	60" x 27" x 46"



1 sliding door / 2 adjustable shelves / 1 bottom shelf

R5AKE-4406	60" x 24" x 46"
R5AKG-4406	60" x 27" x 46"



5 drawers / 1 roll-out shelf

R5AKE-5801	60" x 24" x 60"
R5AKG-5801	60" x 27" x 60"



9 drawers

R5AKE-5803	60" x 24" x 60"
R5AKG-5803	60" x 27" x 60"

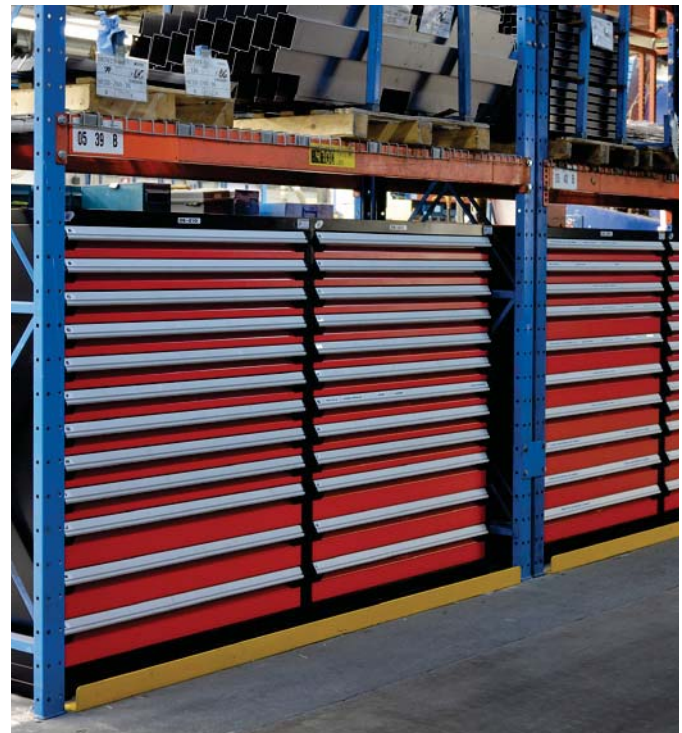

Accessories

Security Accessories and Recommendations

"R" CABINET

Vertical Security Bar **RB10**



Locks all of the cabinet drawers with one padlock;
Safety hasp is located at the top of the bar to facilitate access;
Available to cover overall drawer heights from 24" to 54";
Complete access to drawers is possible, even when installed against a wall;
Possible to install more than one bar on the same cabinet (for different users);
Can be installed on the right.

Product #	Height
RB10-24 LPA	24"
RB10-26 LPA	26"
RB10-30 LPA	30"
RB10-34 LPA	34"
RB10-40 LPA	40"
RB10-54 LPA	54"

Security Panel **RF91**

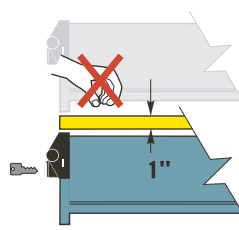

Blocks access between two drawers with locks;
Usable space in cabinet reduced by 1";
Installed between two drawers;
Allows for the cabinet to be divided up for more than one user;
Order by specifying the width and dept.
Ex. : RF91-36 24 for a 36" W x 24" D security panel.

Product #
RF91-____

Cabinet Lock **L3**



Allows user to lock all drawers and roll-out shelves in the cabinet at same time;
Possible to change drawer and roll-out shelf positions;
Easy to retrofit;
Order by adding L3 to the cabinet housing number. Ex. : RA30-302758L3.

Product #
L3

True One-Drawer-at-a-Time System **PATENTED RB15**



Prevents opening several drawers simultaneously. This ensures cabinet stability and protects the users;

To retrofit this mechanism, order RB15-XX-XX; for factory installation, add A to the cabinet housing number;
One kit per cabinet.

Product #	Cabinet Height
RB15-28-08	28"
RB15-30-08	30"
RB15-34-10	34"
RB15-38-11	38"
RB15-44-13	44"
RB15-58-18	58"

Cabinet Safety Hasp **LP**



Allows user to lock all drawers and roll-out shelves in the cabinet at the same time;
Possible to change drawer and roll-out shelf positions;
Alternative to the RB10 vertical security bar;
Easy to retrofit;
Order by adding LP to the cabinet housing number. Ex. : RA30-302758LP.

Product #
LP



Cabinet Tops

Slope Top **RC30**

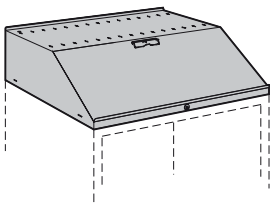

The 30° inclined surface opens to store documents or other items;
Adapted to install a lamp with a 1/2" diameter pivot rod;
Can receive SH52 divider every 2" c/c (except for 18" D);
Capacity : 100 lb (evenly distributed);
For compatibility with doors with frame, choose top that is 3" deeper than your cabinet. Ex. : 27" D cabinet + door with 3" frame = 30" D slope top;
Standard lock included.

Product #	W x D x H	Compatible Divider
RC30-242708L3	24" x 27" x 8"	SH52-1506
RC30-302708L3	30" x 27" x 8"	SH52-1506
RC30-303008L3	30" x 30" x 8"	SH52-1806
RC30-362408L3	36" x 24" x 8"	SH52-1206
RC30-362708L3	36" x 27" x 8"	SH52-1506
RC30-363008L3	36" x 30" x 8"	SH52-1806
RC30-482408L3	48" x 24" x 8"	SH52-1206
RC30-482708L3	48" x 27" x 8"	SH52-1506
RC30-483008L3	48" x 30" x 8"	SH52-1806



Partial Divider **PATENTED SH52**

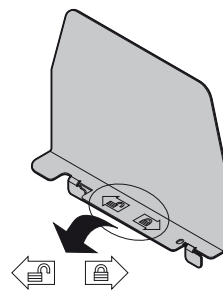

Pictograms to facilitate installation

Innovative patented divider, facilitates easy position changes;
Height : 5 1/2";
Easy installation, without tools.

Product #	Divider Depth
SH52-1206	7 1/8"
SH52-1506	10 1/8"
SH52-1806	13 1/8"

Steel Top with Rubber Mat



Non-slip rubber surface;
Sides and back formed with a double fold, 1" high.

Product #	W x D
RC32-2421-01	24" x 21"
RC32-2427-01	24" x 27"
RC32-3021-01	30" x 21"
RC32-3024-01	30" x 24"
RC32-3027-01	30" x 27"
RC32-3030-01	30" x 30"
RC32-3618-01	36" x 18"
RC32-3621-01	36" x 21"
RC32-3624-01	36" x 24"
RC32-3627-01	36" x 27"
RC32-3630-01	36" x 30"

Product #	W x D
RC32-4224-01	42" x 24"
RC32-4227-01	42" x 27"
RC32-4824-01	48" x 24"
RC32-4827-01	48" x 27"
RC32-4830-01	48" x 30"
RC32-6024-01	60" x 24"
RC32-6027-01	60" x 27"
RC32-6030-01	60" x 30"
RC32-7224-01	72" x 24"
RC32-7227-01	72" x 27"
RC32-7230-01	72" x 30"

RC32 Laminated Wood Top



Made of laminated hardwood strips;
Rounded 90° edge at the front for added comfort;
Thickness : 1 3/4";
Good impact resistance;
Attractive look.

Product #	W x D
WS14-3027A*	30" x 27"
WS14-3030A*	30" x 30"
WS14-3624A	36" x 24"
WS14-3627A*	36" x 27"
WS14-3630A*	36" x 30"
WS14-4224A*	42" x 24"
WS14-4227A*	42" x 27"
WS14-4824A*	48" x 24"
WS14-4827A*	48" x 27"
WS14-4830A*	48" x 30"

Product #	W x D
WS14-6024A*	60" x 24"
WS14-6027A*	60" x 27"
WS14-6030A	60" x 30"
WS14-7224A	72" x 24"
WS14-7227A*	72" x 27"
WS14-7230A	72" x 30"

NOTE *Please check with your customer service representative for lead time.

Stainless Steel Top



Serves as a work surface and protects cabinet against impacts;
Composite wood top with stainless steel cover (brushed finish #4);
Excellent corrosion and chemical resistance;
The top respects the CARB regulations on formaldehyde emissions;
Welded corner for attractive look;
Thickness : 1 3/4".

Product #	W x D
RC35-3027	30" x 27"
RC35-3624	36" x 24"
RC35-3627	36" x 27"
RC35-3630	36" x 30"
RC35-4824	48" x 24"
RC35-4827	48" x 27"

Product #	W x D
RC35-4830	48" x 30"
RC35-6024	60" x 24"
RC35-6027	60" x 27"
RC35-6030	60" x 30"
RC35-7224	72" x 24"
RC35-7230	72" x 30"

RC35

Galvanized Steel Top



Serves as a work surface and protects cabinet against impacts;
Composite wood top with galvanized steel cover;
The top respects the CARB regulations on formaldehyde emissions;
Thickness : 1 3/4".

Product #	W x D
RC36-3027	30" x 27"
RC36-3030	30" x 30"
RC36-3624	36" x 24"
RC36-3627	36" x 27"
RC36-3630	36" x 30"
RC36-4224	42" x 24"
RC36-4227	42" x 27"
RC36-4824	48" x 24"

Product #	W x D
RC36-4827	48" x 27"
RC36-4830	48" x 30"
RC36-6024	60" x 24"
RC36-6027	60" x 27"
RC36-6030	60" x 30"
RC36-7224	72" x 24"
RC36-7227	72" x 27"
RC36-7230	72" x 30"

RC36

Painted Steel Top



Serves as a work surface and protects cabinet against impacts;
Composite wood top with painted steel cover;
The top respects the CARB regulations on formaldehyde emissions;
Welded corners for attractive look;
Thickness : 1 3/4".

Product #	W x D
RC37-3027	30" x 27"
RC37-3030	30" x 30"
RC37-3624	36" x 24"
RC37-3627	36" x 27"
RC37-3630	36" x 30"
RC37-4224	42" x 24"
RC37-4227	42" x 27"
RC37-4824	48" x 24"

Product #	W x D
RC37-4827	48" x 27"
RC37-4830	48" x 30"
RC37-6024	60" x 24"
RC37-6027	60" x 27"
RC37-6030	60" x 30"
RC37-7224	72" x 24"
RC37-7227	72" x 27"
RC37-7230	72" x 30"

RC37

Back and Side Stop

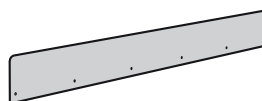

Painted steel : WS18;
Stainless steel : WS98;
Can be installed on back or sides according to top dimensions;
Can be installed on WS14, RC35, RC36 and RC37 tops;
Height : 5". Clears top by approx. 3 1/4";
To order, complete the part # with steel choice needed.

Product #	Length
WS_-2405	24"
WS_-2705	27"
WS_-3005	30"
WS_-3605	36"
WS_-4205	42"
WS_-4805	48"
WS_-6005	60"
WS_-7205	72"

NOTE

For compatibility with doors with frame, choose top that is 3" deeper than your cabinet.
Ex. : 27" D cabinet + door with 3" frame = 30" D top.

Accessories

Power Feed Panel / Cover Panel

"R" CABINET

Power Feed Panel

RC64 / RC65



Painted steel: RC64;
Stainless steel: RC65;

Includes a power bar with 6 outlets (15A or 20A), a perforation for air connection and a perforation (covered with a finishing panel) for installation of a telephone jack or computer network;

Available with or without back finishing panel;
Installs on RC35/RC37 tops;

Indicate type of finish when ordering.
Ex. : RC64-3001 for painted steel.

Product #	Amp	Width	With or Without back panel
RC_-3001	15A	30"	without back panel
RC_-3002	15A	30"	with back panel
RC_-3003	20A	30"	without back panel
RC_-3004	20A	30"	with back panel
RC_-3601	15A	36"	without back panel
RC_-3602	15A	36"	with back panel
RC_-3603	20A	36"	without back panel
RC_-3604	20A	36"	with back panel
RC_-4801	15A	48"	without back panel
RC_-4802	15A	48"	with back panel
RC_-4803	20A	48"	without back panel
RC_-4804	20A	48"	with back panel
RC_-6001	15A	60"	without back panel
RC_-6002	15A	60"	with back panel
RC_-6003	20A	60"	without back panel
RC_-6004	20A	60"	with back panel
RC_-7201	15A	72"	without back panel
RC_-7202	15A	72"	with back panel
RC_-7203	20A	72"	without back panel
RC_-7204	20A	72"	with back panel

NOTE If your order the 20A version, ensure that your building has 20A circuits with the special outlets required.

Cover Panel

RC66 / RC67



Painted steel : RC66;
Stainless steel: RC67;

Can be combined with a power feed panel on the same workstation or cabinet;

Available with or without back finishing panel;
Installs on RC35/RC37 tops;

Indicate type of finish when ordering.
Ex. : RB66-3001 for stainless steel.

Product #	Width	With or Without back panel
RC_-2401	24"	without back panel
RC_-2402	24"	with back panel
RC_-3001	30"	without back panel
RC_-3002	30"	with back panel
RC_-3601	36"	without back panel
RC_-3602	36"	with back panel
RC_-4801	48"	without back panel
RC_-4802	48"	with back panel
RC_-6001	60"	without back panel
RC_-6002	60"	with back panel
RC_-7201	72"	without back panel
RC_-7202	72"	with back panel



R5XHG-1032

Finishing Panel for Computer Support

RC68 / RC69

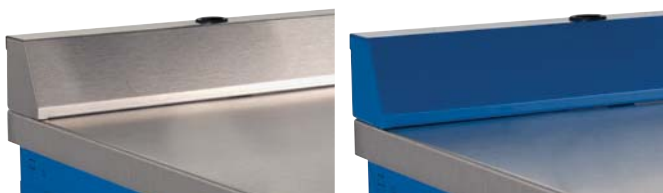

Painted steel: RC68;
Stainless steel: RC69;

Can be installed with a power feed panel or a cover panel.

Order by indicating the type of finish.
Ex. : RC68-2401 for painted steel;

Available with or without back finishing panel;
Equipped with a perforation on the top for installation of RC57/RC58 computer supports.

Product #	Width	With or Without back panel
RC_-2401	24"	without back panel
RC_-2402	24"	with back panel

Computer Supports

Laptop Support



RC58-01



Can be used for a laptop computer or an electronic device etc;

Usable tray surface 14" W X 12" D;

Installs on the work surface, with the RC68/RC69 finishing panel for computer support;

Compatible with the following work surfaces : WS14, RC35, RC36, RC37;

Stainless steel upright, 17" H;

Arm, adapter and tray in painted steel. Color : black;

The tray for laptop is adjustable at 13" height to accommodate different users;

The tray is equipped with non-slip strips (Velcro®) to ensure the laptop doesn't slide.

Product #
RC58-01

LCD Monitor Support



RC57-01



Can be used to support most LCD monitors available on the market ;

Installs on the work surface, with the RC68/RC69 finishing panel for computer support;

Compatible with the following work surfaces : WS14, RC35, RC36, RC37;

Stainless steel upright, 17" H;

Arm and adapter in painted steel. Color: black;

The LCD monitor support is adjustable at 13" height to accommodate different monitor dimensions and different users;

Positioning of monitor anchors according to VESA75 and 100 standards.

Product #
RC57-01

LCD Monitor, Keyboard and Mouse Support

RC58-02



Installs on the work surface, with the RC68/RC69 finishing panel for computer support;

Compatible with the following work surfaces : WS14, RC35, RC36, RC37;

Stainless steel upright, 17" H;

Arm, adaptor and tray in painted steel. Color: black;

The keyboard and mouse tray is adjustable at 13" height to accommodate different users;

Usable surface of the keyboard and mouse tray : 23 5/8" W x 8 1/2" D;

The LCD monitor support is adjustable at 13" height to accommodate different monitor dimensions and different users;

Can support most LCD monitors available on the market;

Positioning of monitor anchors according to VESA75 and 100 standards.

Product #
RC58-02

Double LCD Monitor Support



RC57-03



Can be used to support two LCD monitors ;

Installs on the work surface, with the RC68/RC69 finishing panel for computer support;

Compatible with the following work surfaces : WS14, RC35, RC36, RC37;

Stainless steel upright, 17" H;

Arm and adapter in painted steel. Color: black;

The LCD monitor support is adjustable at 13" height to accommodate different monitor dimensions and different users;

Positioning of monitor anchors according to VESA75 and 100 standards.

Product #
RC57-03

ESD Protection

ESD Cabinet

RC50



Allows for the safe storage of electronic components;

Special paint dissipates electric charges;

Grounding cord and ground wrist strap socket are included. Cord resistance is 1 M Ω;

To order a cabinet equipped with protection against electrostatic discharges, indicate RC50-01. Dissipative paint is Black 090.

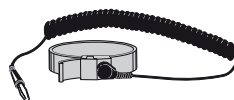

GROUNDING WRIST STRAP

Made of stretch material;

Comes with a 6" cord with 1M Ω resistance;

Dissipates electric charges that may damage electronic components.

Product #
70000320

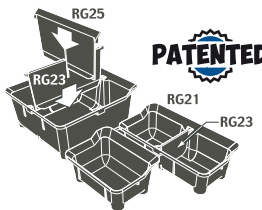

CONDUCTIVE PLASTIC BINS

SEE PAGE 154

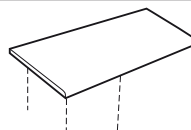

DISSIPATIVE TOP

SEE PAGE 96

Stacking Cabinets / Sink Cabinets

Stacking Cabinets

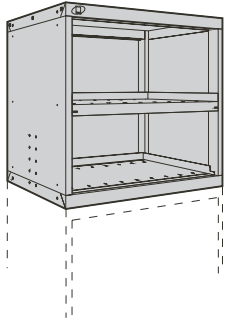

1 shelf, adjustable every 1" c/c;
 1 bottom shelf;
 Standard lock included on doors;
 Choice of doors. Complete the product # by referring to chart below;
 Heights available : 24" and 30";
 To order, complete part # with height wanted and by referring to chart below for door types.
 Ex. : R5HEE-24 03 for a 36" W x 24" D x 24" H cabinet with double integrated doors.

Product #	W x D
R5HDG-___	30" x 27"
R5HEC-___	36" x 18"
R5HEE-___	36" x 24"
R5HEG-___	36" x 27"
R5HHE-___	48" x 24"
R5HHG-___	48" x 27"
R5HKE-___	60" x 24"
R5HKG-___	60" x 27"



Choice of Doors

Cabinet Widths

		30"	36"	48"	60"
00	Without door	X	X	X	X
01	Single integrated door	X	X		
02	Single integrated glass door	X	X		
03	Double integrated doors	X	X	X	X
04	Double integrated glass doors	X	X	X	X
05	Double doors with frame	X	X	X	X
06	Double glass doors with frame	X	X	X	X
07	Integrated sliding doors			X	X
08	Integrated sliding glass doors			X	X
09	Sliding doors with frame			X	X
10	Sliding glass doors with frame			X	X



R5XE-1002

Partial Divider **PATENTED**

SH52

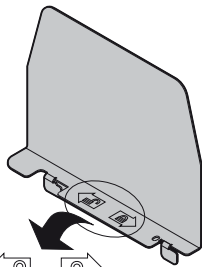

Pictograms to facilitate installation.

Innovative patented divider, facilitates easy position changes;
 Height : 5 1/2";
 Easy installation, without tools.

Product #	Divider Depth	For Shelves
SH52-1506	10 1/8"	18" D
SH52-1806	13 1/8"	21" D
SH52-2106	16 1/8"	24" D
SH52-2406	19 1/8"	27" D



R5XTG-3002

NOTE Sink is not provided by Rousseau

Sink Cabinet

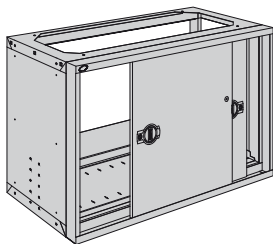

The top has an opening to allow for installation of a sink;
 Has an opening on the back of the housing to allow for installation of a drain and pipes;
 1 bottom shelf;
 Models that have a door with frame are compatible with drawers and roll-out shelves;
 Standard lock included;
 Compatible with bases;
 Heights available : 28", 30" and 34";

SEE PAGE 19

To order, complete the part # with height wanted and by referring to chart below for door types.
 Ex. : R5TDD-28 01;



NOTE Work surfaces must be ordered separately (cut-outs are not provided by Rousseau). Sink not included.

SEE PAGE 96

Product #	W x D
R5TDD-___*	30" x 21"
R5TDG-___*	30" x 27"
R5THD-___	48" x 21"
R5THG-___	48" x 27"

*Models are not compatible with sliding doors.

01	Single integrated door
02	Double integrated doors
03	Double doors with frame
04	Integrated sliding doors
05	Sliding doors with frame

Stacking Cabinets

Stacking Cabinet Housing

RA30

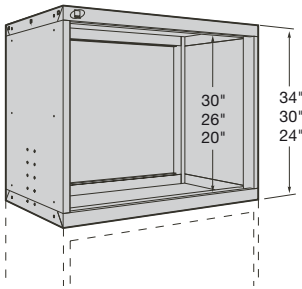

Stacking cabinet housings are designed specifically for stacking on RA30 standard housing units;

Drawers, roll-out shelves, adjustable shelves and bottom shelves can all be installed in these housings;

Compatible with both integrated doors and doors with frame;

Housing heights available : 24", 30" and 34";

To order, complete the part # with height wanted. Ex. : RA30-242130.

Product #	W x D
RA30-2421	24" x 21"
RA30-2427	24" x 27"
RA30-3021	30" x 21"
RA30-3027	30" x 27"
RA30-3618	36" x 18"
RA30-3624	36" x 24"
RA30-3627	36" x 27"

Product #	W x D
RA30-4824	48" x 24"
RA30-4827	48" x 27"
RA30-6024	60" x 24"
RA30-6027	60" x 27"

NOTE Bottom shelf must be ordered separately.

Adjustable Shelf

RB22 / RB24

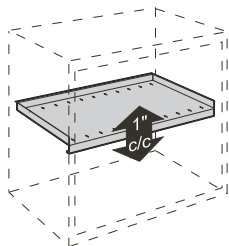

For storing bulky items;

Has edge along the sides and back to prevent items from falling into the bottom of the cabinet;

Adjustable at every 1" c/c;

Up to 400 lb capacity of evenly distributed load;

SH52 dividers can be installed.

Product #	W x D	Capacity*
RB22-2421	24" x 21"	200
RB22-2427	24" x 27"	200
RB24-3021	30" x 21"	400
RB24-3027	30" x 27"	400
RB24-3618	36" x 18"	400
RB24-3624	36" x 24"	400
RB24-3627	36" x 27"	400
RB24-4821	48" x 21"	400
RB24-4824	48" x 24"	400
RB24-4827	48" x 27"	400
RB24-6024	60" x 24"	400
RB24-6027	60" x 27"	400

*in pounds

Bottom Shelf

RB23 / RB25

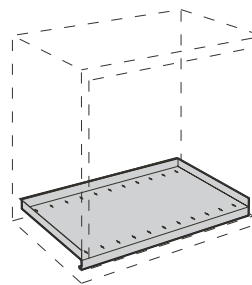

For storing bulky items;

Has edge along the sides and back to prevent items from falling into the bottom of the cabinet;

Up to 400 lb capacity of evenly distributed load;

SH52 dividers can be installed.

Product #	W x D	Capacity*
RB23-2421	24" x 21"	200
RB23-2427	24" x 27"	200
RB25-3021	30" x 21"	400
RB25-3027	30" x 27"	400
RB25-3618	36" x 18"	400
RB25-3624	36" x 24"	400
RB25-3627	36" x 27"	400
RB25-4821	48" x 21"	400
RB25-4824	48" x 24"	400
RB25-4827	48" x 27"	400
RB25-6024	60" x 24"	400
RB25-6027	60" x 27"	400

* in pounds

NOTE

For compatibility with double integrated doors or integrated sliding doors, order an adjustable shelf.

Waste & Recycling Cabinets or Drawer

Waste and Recycling Cabinet

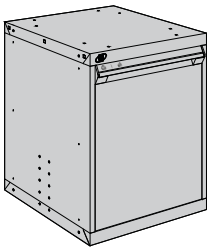

Cabinet can be used as a single unit, integrated in cabinet combinations (ex. : counter cabinets) or integrated underneath the worksurface;

Allows sorting objects for recycling;

Equipped with one 26" H drawer with identification on the drawer handle to facilitate sorting;

Equipped with two 15 1/4" W x 11" D x 20" H containers, the black one for waste and the blue one for recycling;

The drawer has one divider to stabilize the containers and also allows storing objects behind.

Product #	W x D x H
R5XCG-1100	24" x 27" x 30"
R5XDG-1100	30" x 27" x 30"

Waste & Recycling Drawer



Allows sorting objects for recycling;

Identification on the drawer handle to facilitate sorting;

Drawer heights available : 17" and 26";

The 17" H drawer has two containers of 14 3/8" W x 10 1/4" D x 15" H, the black one for waste and the blue one for recycling;

The 26" H drawer has two containers of 15 1/4" W x 11" D x 20" H, the black one for waste and the blue one for recycling;

The drawer has one divider to stabilize the containers and also allows storing objects behind;

To add a locking or security mechanism, complete with product # needed.

Ex. : R51CG-X1701A to add an integrated lock-in mechanism.

Product #	W x D x H
R51CG-X1701	24" x 27" x 17"
R51CG-X2601	24" x 27" x 26"
R51DG-X1701	30" x 27" x 17"
R51DG-X2601	30" x 27" x 26"

Accessories

Doors

"R" CABINET

Single Integrated Door, Solid or Glass RB30 / RB31

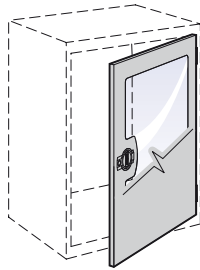

Integrated door : RB30;
 Glass integrated door : RB31;
 Single door for 24", 30" and 36" wide cabinets;
 Compatible with RB23/RB25 bottom shelf and RB22/RB24 adjustable shelf;
 Opens 180° for full access to items stored inside;
 Factory installed on RA30 cabinet housings;
 Standard lock included;
 To receive a safety hasp instead of a standard lock, replace L3 by LP in the product #;



Some door heights may be combined with drawers mounted above or below. In the latter case, you must order a RB22/RB24 adjustable shelf for installation above the section of drawers;

Glass door made of impact resistant polycarbonate;

Order by specifying the choice of door.
 Ex. : RB31-3034L3 for a 30" W x 34" H single integrated glass door;

Note : Not compatible with RF31 drawer or RF40/RF44 roll-out shelf.

Double Integrated Doors, Solid or Glass RB35 / RB36

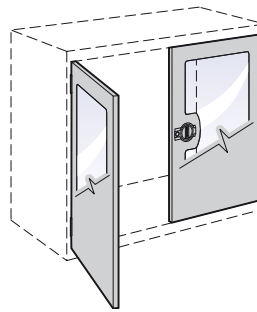

Integrated doors : RB35;
 Glass integrated doors : RB36;
 Double doors for 30", 36", 48" and 60" wide cabinets;
 Compatible with RB24 adjustable shelf;
 Open 180° for full access to items stored inside;
 Factory installed on RA30 cabinet housings;
 Standard lock included;

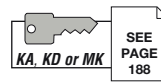

To receive a safety hasp instead of a standard lock, replace L3 by LP in the product #;

Some door heights may be combined with drawers mounted above or below. In the latter case, you must order a RB24 adjustable shelf for installation above the section of drawers or a crossbar (RB70) for drawers mounted above;

Glass doors made of impact resistant polycarbonate;

Order by specifying the choice of door.
 Ex. : RB36-4820L3 for 48"W x 20"H double integrated glass doors;

Note : Not compatible with RF31 drawer or RF40/RF44 roll-out shelf;

Note : Not compatible with RB25 bottom shelf.

Product #	W x H
RB_-2420L3	24" x 20"
RB_-2424L3	24" x 24"
RB_-2426L3	24" x 26"
RB_-2430L3	24" x 30"
RB_-2434L3	24" x 34"
RB_-3020L3	30" x 20"
RB_-3024L3	30" x 24"
RB_-3026L3	30" x 26"
RB_-3030L3	30" x 30"

Product #	W x H
RB_-3034L3	30" x 34"
RB_-3040L3	30" x 40"
RB_-3054L3	30" x 54"
RB_-3620L3	36" x 20"
RB_-3624L3	36" x 24"
RB_-3626L3	36" x 26"
RB_-3630L3	36" x 30"
RB_-3634L3	36" x 34"
RB_-3640L3	36" x 40"
RB_-3654L3	36" x 54"

Product #	W x H
RB_-3020L3	30" x 20"
RB_-3024L3	30" x 24"
RB_-3026L3	30" x 26"
RB_-3030L3	30" x 30"
RB_-3034L3	30" x 34"
RB_-3040L3	30" x 40"
RB_-3054L3	30" x 54"
RB_-3620L3	36" x 20"
RB_-3624L3	36" x 24"
RB_-3626L3	36" x 26"
RB_-3630L3	36" x 30"
RB_-3634L3	36" x 34"
RB_-3640L3	36" x 40"
RB_-3654L3	36" x 54"

Product #	W x H
RB_-4820L3	48" x 20"
RB_-4824L3	48" x 24"
RB_-4826L3	48" x 26"
RB_-4830L3	48" x 30"
RB_-4834L3	48" x 34"
RB_-4840L3	48" x 40"
RB_-4854L3	48" x 54"
RB_-6020L3	60" x 20"
RB_-6024L3	60" x 24"
RB_-6026L3	60" x 26"
RB_-6030L3	60" x 30"
RB_-6034L3	60" x 34"
RB_-6040L3	60" x 40"
RB_-6054L3	60" x 54"



R5AHE-4411

Crossbar for Double Integrated Doors RB70

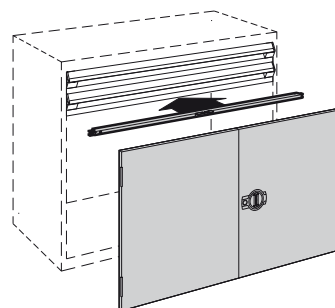

Required for double integrated doors with drawer above.

Product #	Width
RB70-30	30"
RB70-36	36"
RB70-48	48"
RB70-60	60"

Double Doors with Frame, Solid or Glass RB45 / RB46

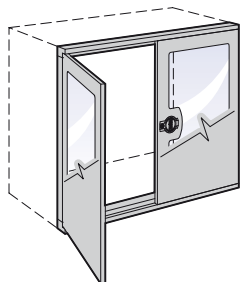

Doors with frame : RB45;
 Glass doors with frame : RB46;
 Double doors for 30", 36", 48" and 60" wide cabinets;
 Can be installed on cabinets with drawers or roll-out shelves;
 Open 180° for full access to items stored inside;
 Factory installed on RA30 cabinet housings;
 Standard lock included;
 To receive a safety hasp instead of a standard lock, replace L3 by LP in the product #;
 Frame thickness : 3";
 Glass door made of impact resistant polycarbonate;
 Order by specifying the choice of door.
 Ex. : RB46-4824L3 for 48" W x 24" H double glass doors with frame.

Product #	W x H
RB_-3024L3	30" x 24"
RB_-3028L3	30" x 28"
RB_-3030L3	30" x 30"
RB_-3034L3	30" x 34"
RB_-3038L3	30" x 38"
RB_-3044L3	30" x 44"
RB_-3058L3	30" x 58"
RB_-3624L3	36" x 24"
RB_-3628L3	36" x 28"
RB_-3630L3	36" x 30"
RB_-3634L3	36" x 34"
RB_-3638L3	36" x 38"
RB_-3644L3	36" x 44"
RB_-3658L3	36" x 58"

Product #	W x H
RB_-4824L3	48" x 24"
RB_-4828L3	48" x 28"
RB_-4830L3	48" x 30"
RB_-4834L3	48" x 34"
RB_-4838L3	48" x 38"
RB_-4844L3	48" x 44"
RB_-4858L3	48" x 58"
RB_-6024L3	60" x 24"
RB_-6028L3	60" x 28"
RB_-6030L3	60" x 30"
RB_-6034L3	60" x 34"
RB_-6038L3	60" x 38"
RB_-6044L3	60" x 44"
RB_-6058L3	60" x 58"



R5XKG-1001

Integrated Sliding Doors, Solid or Glass RB50 / RB51

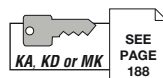
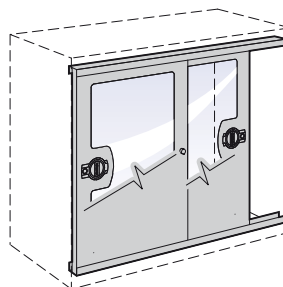

Sliding doors : RB50;
 Glass sliding doors : RB51;
 Doors for single cabinets 48" and 60" wide;
 Compatible with RB24 adjustable shelf;
 Maximum opening for access to items stored inside;
 Factory installed on RA30 housings;
 Standard lock included;
 Glass door made of impact resistant polycarbonate;
 Order by specifying the choice of door.
 Ex. : RB51-6020L3 for 60" W x 20" H integrated sliding glass doors;
 Note : Not compatible with RF31 drawer or RF40/RF44 roll-out shelf.
 Note : Not compatible with RB25 bottom shelf.

Product #	W x H
RB_-4820L3	48" x 20"
RB_-4824L3	48" x 24"
RB_-4826L3	48" x 26"
RB_-4830L3	48" x 30"
RB_-4834L3	48" x 34"
RB_-4840L3	48" x 40"
RB_-4854L3	48" x 54"

Product #	W x H
RB_-6020L3	60" x 20"
RB_-6024L3	60" x 24"
RB_-6026L3	60" x 26"
RB_-6030L3	60" x 30"
RB_-6034L3	60" x 34"
RB_-6040L3	60" x 40"
RB_-6054L3	60" x 54"

Sliding Doors with Frame, Solid or Glass RB55 / RB56

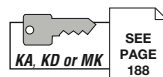
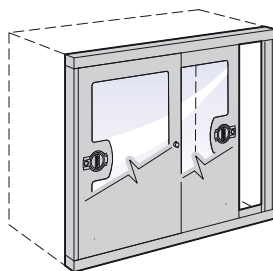

Sliding doors with frame : RB55;
 Glass sliding doors with frame : RB56;
 Sliding doors for double cabinets (2 x 24" or 2 x 30");
 Compatible with double cabinets (2 x 24" or 2 x 30") with drawers or roll-out shelves;
 Maximum opening for access to items stored inside;
 Factory installed on RA30 cabinet housings;
 Standard lock included;
 Frame thickness : 3";
 Glass door made of impact resistant polycarbonate;
 Order by specifying the choice of door.
 Ex. : RB56-6024L3 for 60"W x 24"H sliding glass door with frame;
 Note: Not compatible with 48" and 60" wide simples cabinets.

Product #	W x H
RB_-4824L3	48" x 24"
RB_-4828L3	48" x 28"
RB_-4830L3	48" x 30"
RB_-4834L3	48" x 34"
RB_-4838L3	48" x 38"
RB_-4844L3	48" x 44"
RB_-4858L3	48" x 58"

Product #	W x H
RB_-6024L3	60" x 24"
RB_-6028L3	60" x 28"
RB_-6030L3	60" x 30"
RB_-6034L3	60" x 34"
RB_-6038L3	60" x 38"
RB_-6044L3	60" x 44"
RB_-6058L3	60" x 58"

Components

Housings

"R" CABINET

"R" Heavy-Duty Cabinet Housing

RA30

Choose from a wide range of housing unit sizes to customize your storage or work space areas.

Modular drawers, roll-out shelves, adjustable and bottom shelves can be installed;

Compatible with integrated doors and doors with frame;

Housing units are equipped with knock-outs :

- on the top to stack cabinets and install accessories or work surfaces
- on the sides and back to anchor cabinets side-by-side and back-to-back as well as for attaching accessories

Includes anchoring kit for concrete floor, for both cabinet housings and bases, and hardware for stacking;

Cabinet lock allows user to lock all drawers and roll-out shelves in the cabinet at the same time.

Complete product number with L3;

For a safety hasp, complete the product number with LP;

To order a true one-drawer-at-a-time mechanism, complete the product number with A.

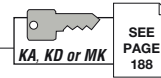

R5AEE-5803

24" and 30" Wide

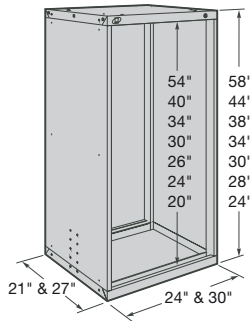

36" Wide

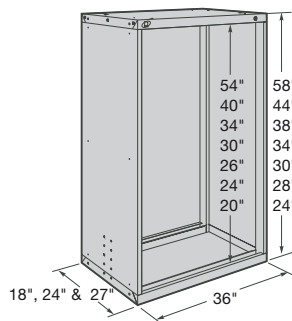

48" and 60" Wide

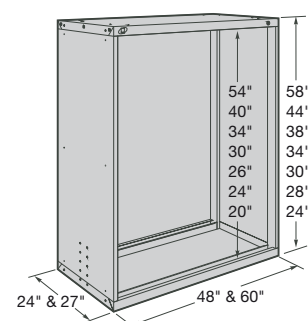

Product #	Total Height	Inside Height
24" x 21"		
RA30-242124	24"	20"
RA30-242128	28"	24"
RA30-242130	30"	26"
RA30-242134	34"	30"
RA30-242138	38"	34"

Product #	Total Height	Inside Height
24" x 27"		
RA30-242724	24"	20"
RA30-242728	28"	24"
RA30-242730	30"	26"
RA30-242734	34"	30"
RA30-242738	38"	34"

Product #	Total Height	Inside Height
30" x 21"		
RA30-302124	24"	20"
RA30-302128	28"	24"
RA30-302130	30"	26"
RA30-302134	34"	30"
RA30-302138	38"	34"
RA30-302144	44"	40"
RA30-302158	58"	54"

Product #	Total Height	Inside Height
30" x 27"		
RA30-302724	24"	20"
RA30-302728	28"	24"
RA30-302730	30"	26"
RA30-302734	34"	30"
RA30-302738	38"	34"
RA30-302744	44"	40"
RA30-302758	58"	54"

Product #	Total Height	Inside Height
36" x 18"		
RA30-361824	24"	20"
RA30-361828	28"	24"
RA30-361830	30"	26"
RA30-361834	34"	30"
RA30-361838	38"	34"
RA30-361844	44"	40"
RA30-361858	58"	54"

Product #	Total Height	Inside Height
36" x 24"		
RA30-362424	24"	20"
RA30-362428	28"	24"
RA30-362430	30"	26"
RA30-362434	34"	30"
RA30-362438	38"	34"
RA30-362444	44"	40"
RA30-362458	58"	54"

Product #	Total Height	Inside Height
36" x 27"		
RA30-362724	24"	20"
RA30-362728	28"	24"
RA30-362730	30"	26"
RA30-362734	34"	30"
RA30-362738	38"	34"
RA30-362744	44"	40"
RA30-362758	58"	54"

Product #	Total Height	Inside Height
48" x 24"		
RA30-482424	24"	20"
RA30-482428	28"	24"
RA30-482430	30"	26"
RA30-482434	34"	30"
RA30-482438	38"	34"
RA30-482444	44"	40"
RA30-482458	58"	54"

Product #	Total Height	Inside Height
48" x 27"		
RA30-482724	24"	20"
RA30-482728	28"	24"
RA30-482730	30"	26"
RA30-482734	34"	30"
RA30-482738	38"	34"
RA30-482744	44"	40"
RA30-482758	58"	54"

Product #	Total Height	Inside Height
60" x 24"		
RA30-602424	24"	20"
RA30-602428	28"	24"
RA30-602430	30"	26"
RA30-602434	34"	30"
RA30-602438	38"	34"
RA30-602444	44"	40"
RA30-602458	58"	54"

Product #	Total Height	Inside Height
60" x 27"		
RA30-602724	24"	20"
RA30-602728	28"	24"
RA30-602730	30"	26"
RA30-602734	34"	30"
RA30-602738	38"	34"
RA30-602744	44"	40"
RA30-602758	58"	54"

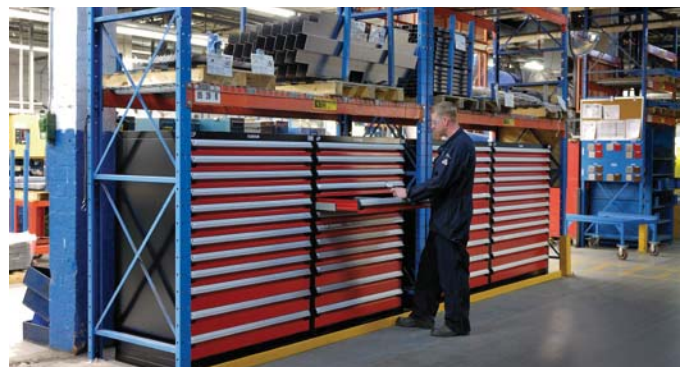

Bases

Front Access Forklift Base

RA52

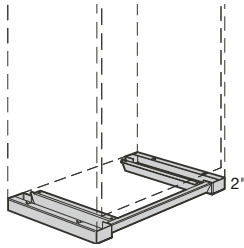

2" high base designed for moving the cabinet from the front with a forklift;
Front cover plate included;
Includes a recessed kick-plate in the center of the cabinet to allow user to stand closer to cabinet;
Designed to enable user to anchor cabinet to the floor;
Compatible with RA74 leveling glides;
Compatible with the RA54 rear base cover plate, offered as an option;
Note: Not compatible with casters;
Note: Not designed for stacking applications.

Product #	W x D
RA52-242102	24" x 21"
RA52-242702	24" x 27"
RA52-302102	30" x 21"
RA52-302702	30" x 27"
RA52-361802	36" x 18"
RA52-362402	36" x 24"
RA52-362702	36" x 27"

Product #	W x D
RA52-482402	48" x 24"
RA52-482702	48" x 27"
RA52-602402	60" x 24"
RA52-602702	60" x 27"

Leveling Glide Kit

RA74

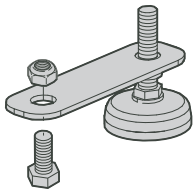

Sold in kits of 4;
Serves to adjust the height of cabinet housings on uneven floor surfaces.

Product #
RA74-01

Recessed Base

RA55 / RA57

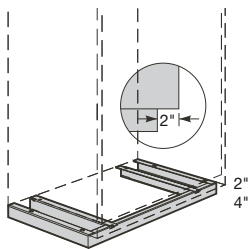

Painted steel RA55;
Stainless steel RA57;
Designed to raise the height of a cabinet by 2" or 4";
Includes a removable cover plate at the front for aesthetics;
Front cover plate is on a straight angle to facilitate cleaning floors;
2" recessed space to allow user to stand closer to cabinet;

Designed to allow user to anchor the cabinet to the floor;
Compatible with RA74 leveling glides;
Compatible with the RA56/RA58 rear base cover plate, offered as an option;
Note: Not compatible with casters;
Note: Not designed for stacking applications;

Order by indicating the type of steel finish. Ex.: RA57-302702 for a stainless steel base 30" W x 27" D x 2" H.

Product #	W x D x H
RA_-242102	24" x 21" x 2"
RA_-242104	24" x 21" x 4"
RA_-242702	24" x 27" x 2"
RA_-242704	24" x 27" x 4"
RA_-302102	30" x 21" x 2"
RA_-302104	30" x 21" x 4"
RA_-302702	30" x 27" x 2"
RA_-302704	30" x 27" x 4"
RA_-361802	36" x 18" x 2"
RA_-361804	36" x 18" x 4"
RA_-362402	36" x 24" x 2"

Product #	W x D x H
RA_-362404	36" x 24" x 4"
RA_-362702	36" x 27" x 2"
RA_-362704	36" x 27" x 4"
RA_-482402	48" x 24" x 2"
RA_-482404	48" x 24" x 4"
RA_-482702	48" x 27" x 2"
RA_-482704	48" x 27" x 4"
RA_-602402	60" x 24" x 2"
RA_-602404	60" x 24" x 4"
RA_-602702	60" x 27" x 2"
RA_-602704	60" x 27" x 4"

Front and Side Access Forklift Base

RA53

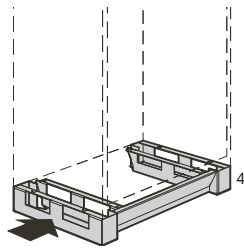

4" high base designed for moving the cabinet from the front or side with a forklift, or from the front with a pallet-jack;
Front cover plate included;
Includes a recessed kick-plate in the center of the cabinet to allow user to stand closer to cabinet;
Designed to enable user to anchor cabinet to the floor;
Compatible with RA74 leveling glides;
Compatible with the RA54 rear base cover plate, offered as an option;
Note: Not compatible with casters;
Note: Not designed for stacking applications.

Product #	W x D
RA53-242104	24" x 21"
RA53-242704	24" x 27"
RA53-302104	30" x 21"
RA53-302704	30" x 27"
RA53-361804	36" x 18"
RA53-362404	36" x 24"
RA53-362704	36" x 27"

Product #	W x D
RA53-482404	48" x 24"
RA53-482704	48" x 27"
RA53-602404	60" x 24"
RA53-602704	60" x 27"

Angled Cover Plate

RA54

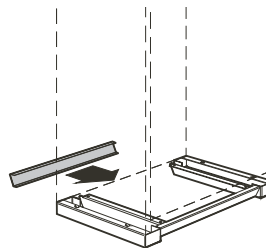

Closes off the back of 2" and 4" forklift bases (RA52 and RA53).

Product #	W x H
RA54-2402	24" x 2"
RA54-2404	24" x 4"
RA54-3002	30" x 2"
RA54-3004	30" x 4"
RA54-3602	36" x 2"
RA54-3604	36" x 4"
RA54-4802	48" x 2"
RA54-4804	48" x 4"
RA54-6002	60" x 2"
RA54-6004	60" x 4"

Straight Cover Plate

RA56 / RA58

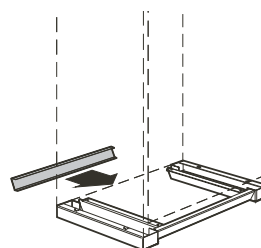

Painted steel RA56;
Stainless steel RA58;
Closes off the back of 2" and 4" recessed bases (RA55 or RA57);

Order by indicating the type of steel finish.
Ex.: RA58-4804 for a straight cover plate in stainless steel 48" W x 4" H.

Product #	W x H
RA_-2402	24" x 2"
RA_-2404	24" x 4"
RA_-3002	30" x 2"
RA_-3004	30" x 4"
RA_-3602	36" x 2"
RA_-3604	36" x 4"
RA_-4802	48" x 2"
RA_-4804	48" x 4"
RA_-6002	60" x 2"
RA_-6004	60" x 4"

Components

Drawers, Roll-out Shelves and Locking or Security Mechanisms

"R" CABINET

Heavy-Duty Modular Drawer for Cabinet

RF31



400 lb capacity, 100% extension;
Heavy-duty construction;
Easy to install;

Vast choice of accessories offered to adapt to your storage needs;

Available drawer heights :
3", 4", 5", 6", 7", 8", 9", 10", 12" and 14";

Order by adding the drawer height to the part #.
Ex. : RF31-362406;

For modular drawers with layouts,

Product #	W x D
RF31-2421	24" x 21"
RF31-2427	24" x 27"
RF31-3021	30" x 21"
RF31-3027	30" x 27"
RF31-3618	36" x 18"
RF31-3624	36" x 24"
RF31-3627	36" x 27"
RF31-4824	48" x 24"
RF31-4827	48" x 27"
RF31-6024	60" x 24"
RF31-6027	60" x 27"

SEE PAGES 151-155

SEE PAGES 137-150

Heavy-Duty Front Access Roll-Out Shelf

RF40



400 lb capacity, 100% extension;
Heavy-duty construction;
Easy to install;

Painted steel with 3" edges on sides and back;
Height : 6";
Full access to contents.

Product #	W x D
RF40-2421	24" x 21"
RF40-2427	24" x 27"
RF40-3021	30" x 21"
RF40-3027	30" x 27"
RF40-3618	36" x 18"
RF40-3624	36" x 24"
RF40-3627	36" x 27"
RF40-4824	48" x 24"
RF40-4827	48" x 27"
RF40-6024	60" x 24"
RF40-6027	60" x 27"

Heavy-Duty 3-Sided Access Roll-Out Shelf

RF44



400 lb capacity, 100% extension;
Heavy-duty construction;
Easy to install;
Galvanized steel with 1 1/2" edge on back;
Height : 5";
May serve as work surface.

Product #	W x D
RF44-2421	24" x 21"
RF44-2427	24" x 27"
RF44-3021	30" x 21"
RF44-3027	30" x 27"
RF44-3618	36" x 18"
RF44-3624	36" x 24"
RF44-3627	36" x 27"
RF44-4824	48" x 24"
RF44-4827	48" x 27"
RF44-6024	60" x 24"
RF44-6027	60" x 27"

Integrated Lock-In Mechanism

PATENTED

A



Activated by tilting the handle up;
Allows user to open the drawer and the roll-out shelf with one hand only;
Close by simply pushing it;
Stops drawer and roll-out shelf from opening on their own;
Easy to retrofit;
Order by adding A to the drawer or partitioning, or roll-out shelf model number.
Ex. : RF31-362406A.

Product #
A

Econo Lock-In Mechanism

B

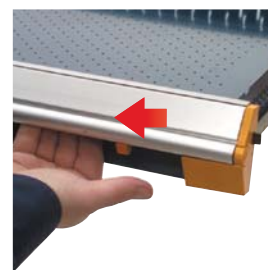

Activated with the right hand by sliding the mechanism with thumb;
Drawer and roll-out shelf close without having to reactivate the slide mechanism;
Stops drawer and roll-out shelf from opening on their own;
Easy to retrofit;
Order by adding B to the drawer or partitioning, or roll-out shelf model number.
Ex.: RF31-362406B.

Product #
B

Drawer Lock

IMPROVED

L3

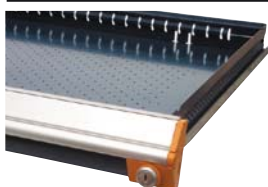

Compatible with all drawer dimensions;
Does not affect usable drawer space;
Easy to retrofit;
Order by adding L3 to drawer or partitioning model number. Ex. : RF31-362406L3.

Product #
L3



KA, KD or MK

SEE PAGE 188

Lock-Out Mechanism

RF85



For both drawers and roll-out shelves;
Locks drawers and roll-out shelves in open position;
Activated manually, only when required;
No interference with drawer accessories.

Product #
RF85



"L" Compact Cabinet

"L" CABINET



The Rousseau Advantages

PATENTED



100 lb capacity per drawer.
100% drawer extension in both drawer depths.

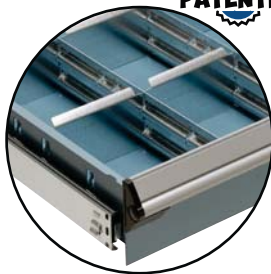

Partitions and dividers are clipped in.



Variety of drawer accessories available: full-depth partitions, dividers, plastic bins, hanging file holders, foam for protection, etc.



Central lock on the cabinet housing.



6 drawer heights available: 3", 4", 5", 6", 8" and 12".

"L" COMPACT CABINET

The new "L" Compact Cabinet has been developed to better meet our clients' needs in terms of dimensions offered, drawer configurations and accessories available for a compact cabinet.

The "L" Compact Cabinet is available in 18" wide, two different depths; 21" and 27". Four cabinet heights are available; 24", 28", 34" and 40". A choice of base (2" or 4") is also possible for raising cabinet height a bit or to free up foot room. A new security system allows you to lock all of the drawers with one central lock.

The drawers come in a choice of 6 different heights from 3" to 12" and can be accessorized with partitions, dividers and plastic bins for the best possible organization of your parts. Each drawer has a 100 lb capacity and ergonomic handles that are easy to grip and look good.

The "L" Compact Cabinet is an excellent alternative to the "R" Heavy-Duty version. Take the time to learn more in the following pages.



L3ABD-2418L3C

L3ABD-3442L3C

Proposals - Cabinets



"L" CABINET

Here are some examples of "L" Compact Cabinet proposals:

Doors are factory installed with hinges on the left. Upon request, doors can be installed with hinges on the right; To order a lock on the cabinet housing (for models with more than one drawer) or on the door, complete the product number with L3;

To order a cabinet with a 4" base, complete the product number with C. Ex.: L3ABD-2401L3C for a 18" x 21" x 24" cabinet, 4 drawers, with lock and 4" base.

IMPORTANT Drawer layouts are included with the proposals. See chart to the left for the number of compartments.

NOTE For models without drawer layouts, change the last 2 numbers of the model to the next sequential even number.
Ex.: L3ABD-2401 with L3ABD-2402 without

Number of Compartments (layout code)		
Drawer dimensions	18" x 21"	18" x 27"
3" to 5"	9 (0206)	9 (0206)
6" and 8"	6 (0104)	6 (0104)
12"	4 (0102)	4 (0102)

24" High

 <p>4 drawers L3ABD-2401__ 18" x 21" x 24" L3ABG-2401__ 18" x 27" x 24"</p>	 <p>4 drawers L3ABD-2403__ 18" x 21" x 24" L3ABG-2403__ 18" x 27" x 24"</p>	 <p>4 drawers L3ABD-2405__ 18" x 21" x 24" L3ABG-2405__ 18" x 27" x 24"</p>	 <p>3 drawers L3ABD-2407__ 18" x 21" x 24" L3ABG-2407__ 18" x 27" x 24"</p>	 <p>4 drawers L3ABD-2409__ 18" x 21" x 24" L3ABG-2409__ 18" x 27" x 24"</p>
--	--	--	---	--

 <p>1 door / 1 shelf L3ABD-2412__ 18" x 21" x 24" L3ABG-2412__ 18" x 27" x 24"</p>	 <p>3 drawers L3ABD-2413__ 18" x 21" x 24" L3ABG-2413__ 18" x 27" x 24"</p>	 <p>3 drawers L3ABD-2415__ 18" x 21" x 24" L3ABG-2415__ 18" x 27" x 24"</p>	 <p>4 drawers L3ABD-2417__ 18" x 21" x 24" L3ABG-2417__ 18" x 27" x 24"</p>	 <p>5 drawers L3ABD-2419__ 18" x 21" x 24" L3ABG-2419__ 18" x 27" x 24"</p>
--	---	---	--	---

28" High

 <p>4 drawers L3ABD-2801__ 18" x 21" x 28" L3ABG-2801__ 18" x 27" x 28"</p>	 <p>4 drawers L3ABD-2807__ 18" x 21" x 28" L3ABG-2807__ 18" x 27" x 28"</p>	 <p>2 drawers L3ABD-2809__ 18" x 21" x 28" L3ABG-2809__ 18" x 27" x 28"</p>	 <p>5 drawers L3ABD-2817__ 18" x 21" x 28" L3ABG-2817__ 18" x 27" x 28"</p>	 <p>4 drawers L3ABD-2819__ 18" x 21" x 28" L3ABG-2819__ 18" x 27" x 28"</p>
--	--	--	---	--

 <p>6 drawers L3ABD-2821__ 18" x 21" x 28" L3ABG-2821__ 18" x 27" x 28"</p>	 <p>6 drawers L3ABD-2825__ 18" x 21" x 28" L3ABG-2825__ 18" x 27" x 28"</p>	 <p>2 doors / 1 shelf L3ABD-2828__ 18" x 21" x 28" L3ABG-2828__ 18" x 27" x 28"</p>	 <p>1 drawer / 1 door L3ABD-2829__ 18" x 21" x 28" L3ABG-2829__ 18" x 27" x 28"</p>	 <p>4 drawers L3ABD-2835__ 18" x 21" x 28" L3ABG-2835__ 18" x 27" x 28"</p>
--	--	--	---	--



Proposals - Cabinets

11" CABINET

34" High

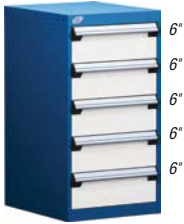

5 drawers
L3ABD-3403 18" x 21" x 34"
L3ABG-3403 18" x 27" x 34"



4 drawers
L3ABD-3407 18" x 21" x 34"
L3ABG-3407 18" x 27" x 34"



1 drawer / 1 door / 1 shelf
L3ABD-3411 18" x 21" x 34"
L3ABG-3411 18" x 27" x 34"



5 drawers
L3ABD-3415 18" x 21" x 34"
L3ABG-3415 18" x 27" x 34"



5 drawers
L3ABD-3419 18" x 21" x 34"
L3ABG-3419 18" x 27" x 34"



4 drawers
L3ABD-3421 18" x 21" x 34"
L3ABG-3421 18" x 27" x 34"



6 drawers
L3ABD-3425 18" x 21" x 34"
L3ABG-3425 18" x 27" x 34"



1 door / 1 shelf
L3ABD-3436 18" x 21" x 34"
L3ABG-3436 18" x 27" x 34"



6 drawers
L3ABD-3437 18" x 21" x 34"
L3ABG-3437 18" x 27" x 34"



1 drawer / 1 door / 1 shelf
L3ABD-3439 18" x 21" x 34"
L3ABG-3439 18" x 27" x 34"

40" High



6 drawers
L3ABD-4005 18" x 21" x 40"
L3ABG-4005 18" x 27" x 40"



2 drawers / 1 door / 1 shelf
L3ABD-4009 18" x 21" x 40"
L3ABG-4009 18" x 27" x 40"



8 drawers
L3ABD-4011 18" x 21" x 40"
L3ABG-4011 18" x 27" x 40"



4 drawers / 1 door / 1 shelf
L3ABD-4015 18" x 21" x 40"
L3ABG-4015 18" x 27" x 40"



3 drawers / 1 door
L3ABD-4017 18" x 21" x 40"
L3ABG-4017 18" x 27" x 40"



2 drawers / 1 door / 1 shelf
L3ABD-4021 18" x 21" x 40"
L3ABG-4021 18" x 27" x 40"



6 drawers
L3ABD-4025 18" x 21" x 40"
L3ABG-4025 18" x 27" x 40"



7 drawers
L3ABD-4027 18" x 21" x 40"
L3ABG-4027 18" x 27" x 40"



6 drawers
L3ABD-4029 18" x 21" x 40"
L3ABG-4029 18" x 27" x 40"



6 drawers
L3ABD-4031 18" x 21" x 40"
L3ABG-4031 18" x 27" x 40"

Proposals - Drawer Compartments



"L" CABINET

You can choose a drawer model from among our proposals with layouts:

00 for layout kit only

51 for a drawer in a cabinet, with layout

EXAMPLE: **L_** **BD-A0200**

Drawer height

SEE PAGE 28

L3 Drawer lock
B Lock-in mechanism

Example : **L51BD-A020008L3B**
for a drawer 18" W x 21" D, with layout, 8" drawer height with lock and lock-in mechanism on drawer.

Drawer dimensions

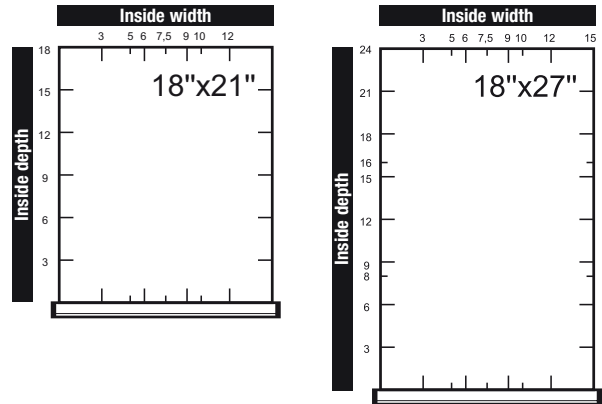

18" X 21" (W X D) Drawers

Partitions and Dividers

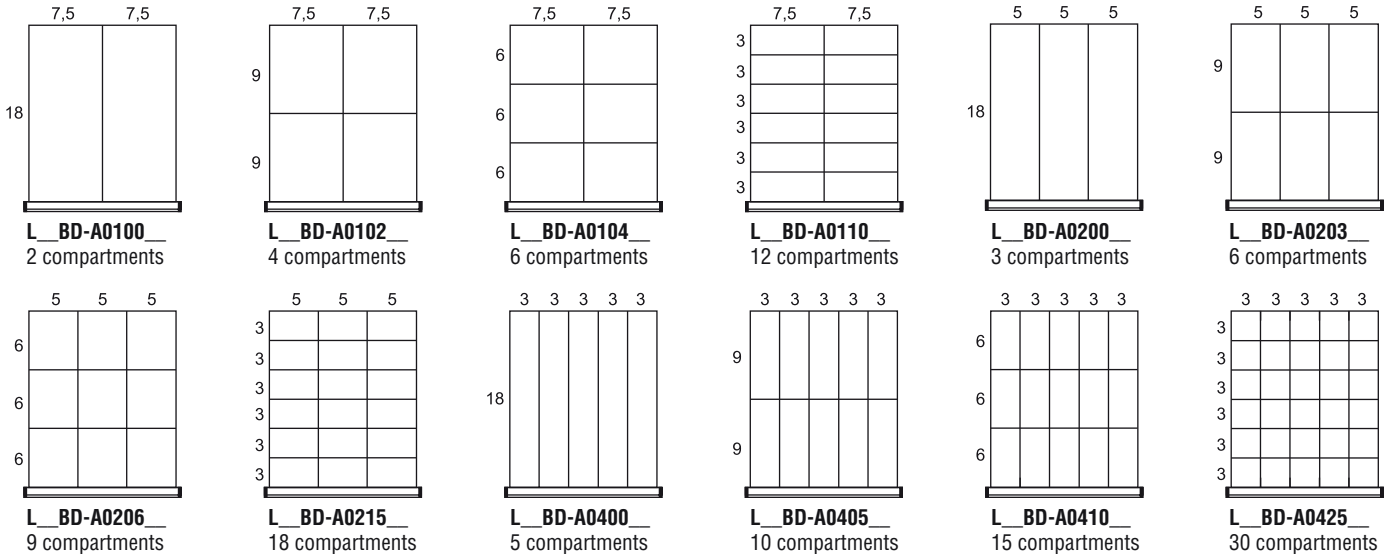

Plastic Bins

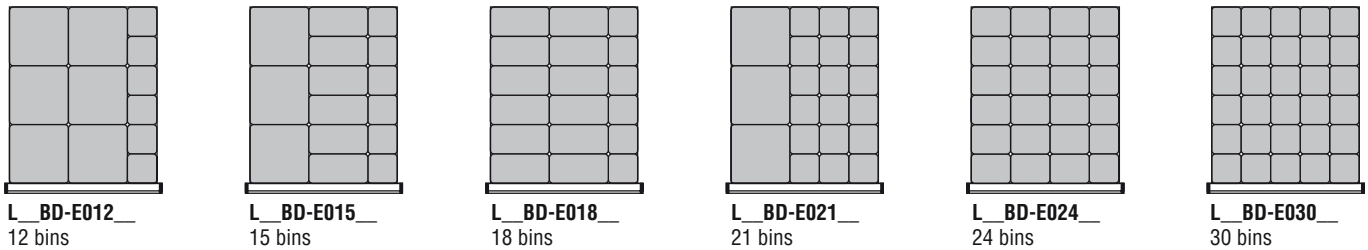

Foam / Liners

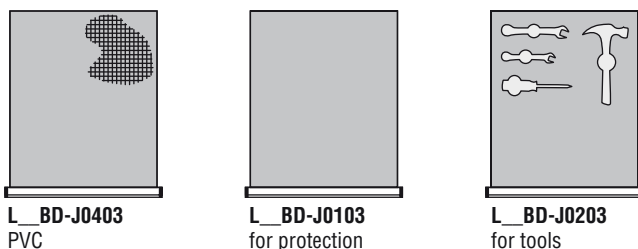

Sold without cut-outs.
For custom cut-outs,

SEE PAGE 189

Folder Hanging Bars

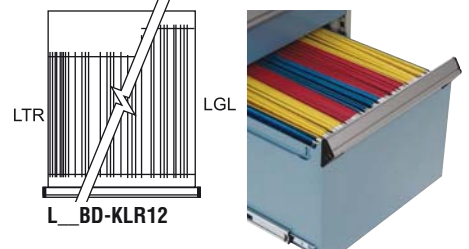



Proposals - Drawer Compartments

18" CABINET

18" X 27" (W X D) Drawers

Partitions and Dividers

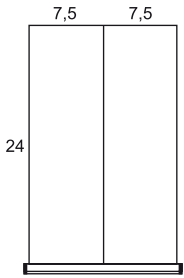

L_BG-A0100
2 compartments

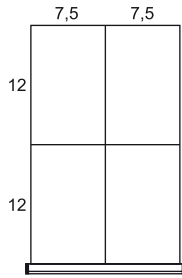

L_BG-A0102
4 compartments

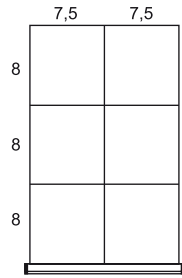

L_BG-A0104
6 compartments

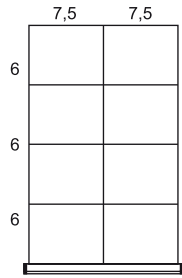

L_BG-A0106
8 compartments

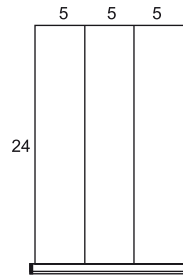

L_BG-A0200
3 compartments

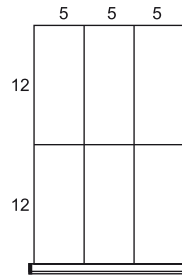

L_BG-A0203
6 compartments

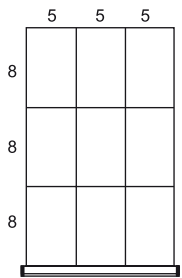

L_BG-A0206
9 compartments

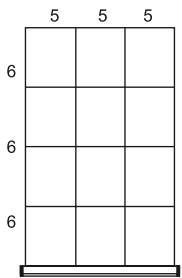

L_BG-A0209
12 compartments

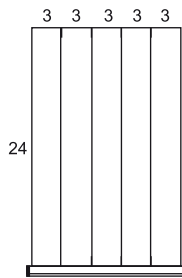

L_BG-A0400
5 compartments

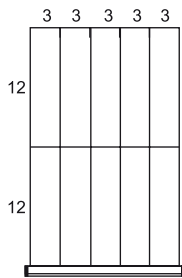

L_BG-A0405
10 compartments

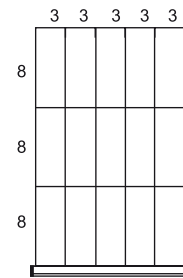

L_BG-A0410
15 compartments

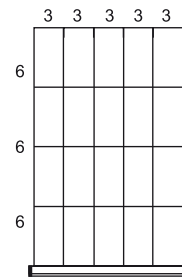

L_BG-A0415
20 compartments

Plastic Bins

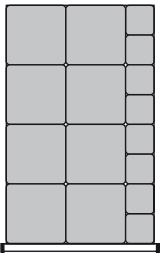

L_BG-E016
16 bins

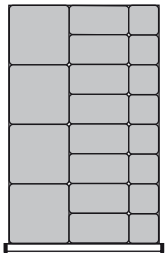

L_BG-E020
20 bins

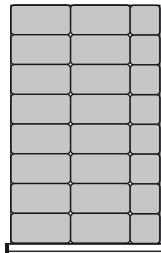

L_BG-E024
24 bins

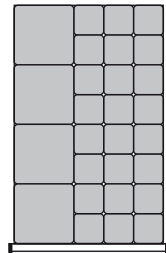

L_BG-E028
28 bins

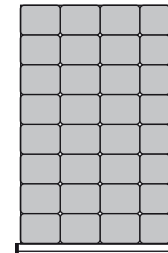

L_BG-E032
32 bins

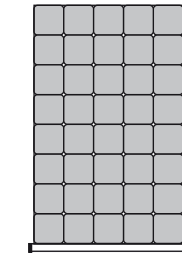

L_BG-E040
40 bins

Foam / Liners

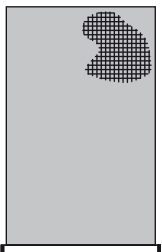

L_BG-J0403
PVC

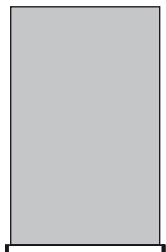

L_BG-J0103
for protection

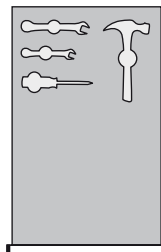

L_BG-J0203
for tools



Sold without cut-outs.
For custom cut-outs,

SEE
PAGE
189

Folder Hanging Bars

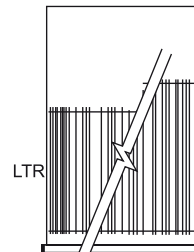

L_BG-KLR12





Security Accessories

"L" CABINET

Drawer Lock L3



2 keys provided with each lock;
Compatible with all drawer dimensions;
The mechanism (covered by a galvanized box) requires 3" W x 1" D inside the drawer;
Order by adding L3 to drawer or partitioning number.
Ex: LF31-182106L3;

Note : A security panel LF91 must be ordered to block access between two drawers if managing two different users.



Product #
L3

Door Lock L3 / LP



2 keys provided with each lock;
To order a lock, complete the door number by L3.
Ex: LB30-1812L3;
To order a safety hasp, complete the door number by LP.
Ex: LB30-1812LP;

Note: A security panel LF91 must be ordered to block access between two doors if managing two different users.

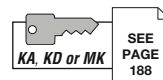

Product #
L3 Lock
LP Safety Hasp

Central Locking Mechanism L3 / LP



Allows user to lock all drawers in the cabinet at the same time;
Easy to retrofit;
Possible to change drawer layout without touching locking mechanism;
To order a lock, complete the product housing number or the proposal cabinet number by L3. Ex.: LA30-182134L3;
To order a safety hasp for padlock, complete the housing number with LP. Ex.: LA30-182134LP.



Product #
L3 Lock
LP Safety hasp

Lock-In Mechanism B



Activated by sliding the mechanism with thumb;
Drawer closes without having to reactivate the slide mechanism;
Stops drawers from opening on their own;
Easy to retrofit;
Order by adding B to the drawer or partitioning number.
Ex.: LF31-182106B.

Product #
B

Drawer and Handle Accessories

Handle Protector LF70



Installs on drawer handle by clipping in place;
Made of transparent plastic;
Protects identification labels from dust, grease and dirt;
Easy to remove;
Note: Labels available; 30 per page - 10 pages. Order LF71-425075.

Product #
LF70-18

PVC Drawer Liner LG40

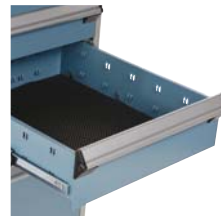

Protects stored objects;
Non-skid surface;
Can be installed under partitions and dividers;
Thickness: 3/32".

Product #	For drawer
LG40-1821-01	18" W x 21" D
LG40-1827-01	18" W x 27" D

Foam for Protection LG41

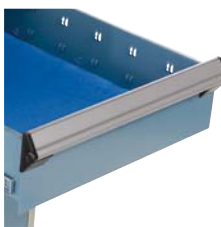

Protects stored objects;
Blue foam 1/4" thick.

Product #	For drawer
LG41-1821-01	18" W x 21" D
LG41-1827-01	18" W x 27" D

NOTE Partitions and dividers may not be installed with this foam.

Foam for Tools LG42



Oil resistant and non-absorbent;
1 blue foam 1/4" thick;
1 black self-adhesive 1/2" thick foam;
Sold without cut-outs. May be cut using a utility knife.

Product #	For drawer
LG42-1821-01	18" W x 21" D
LG42-1827-01	18" W x 27" D

SEE PAGE 189

Folder Hanging Bars LG31



For storing hanging folders;
Can be used for both letter and legal sizes;
Designed for 12" drawers.

Product #
LG31-18



Plastic Bin



RG20

Simplify storing, moving and managing small parts. Lightweight and resistant;
 Designed for 3" and 4" high drawers;
 45° angle for easy identification of bin contents and removal of bins;
 Compatible with partitions and dividers;
 6" plastic bins can be subdivided.



Dimensions			Bin	Product # Partition	Divider
W	D	H			
3"	3"	2"	RG20-030302	-	-
4"	3"	2"	RG20-040302	-	-
6"	3"	2"	RG20-060302	RG22-0302	-
6"	6"	2"	RG20-060602	RG22-0602	RG24-0602
3"	3"	3"	RG20-030303	-	-
4"	3"	3"	RG20-040303	-	-
6"	3"	3"	RG20-060303	RG22-0303	-
6"	6"	3"	RG20-060603	RG22-0603	RG24-0603

Front to Back Partition



LG02

Used to divide the drawer along its depth;
 Clip system locks dividers in place;
 Galvanized steel;
 RG10 dividers can be used in between parti-
 tions to make smaller compartments;
 Compatible with plastic bins and PVC drawer
 liners.

Drawer Depth Nominal (real)	Drawer Height					
	3"	4"	5"	6"	8"	12"
21" (18")	1 5/8" high LG02-2103	2 5/8" high LG02-2104	3 5/8" high LG02-2105	4 5/8" high LG02-2106	6 5/8" high LG02-2108	8 5/8" high LG02-2110
27" (24")	1 5/8" high LG02-2703	2 5/8" high LG02-2704	3 5/8" high LG02-2705	4 5/8" high LG02-2706	6 5/8" high LG02-2708	8 5/8" high LG02-2710

Drawer Divider



Clip in place;
 45° angle for identifying compartment
 contents;
 Adjustable every 3" (c/c).



Divider Width Nominal	Drawer Height					
	3"	4"	5"	6"	8"	12"
3"	1 5/8" high RG10-03003	2 5/8" high RG10-03004	3 5/8" high RG10-03005	4 5/8" high RG10-03006	6 5/8" high RG10-03008	8 5/8" high RG10-03010
5"	1 5/8" high RG10-05003	2 5/8" high RG10-05004	3 5/8" high RG10-05005	4 5/8" high RG10-05006	6 5/8" high RG10-05008	8 5/8" high RG10-05010
6"	1 5/8" high RG10-06003	2 5/8" high RG10-06004	3 5/8" high RG10-06005	4 5/8" high RG10-06006	6 5/8" high RG10-06008	8 5/8" high RG10-06010
7.5"	1 5/8" high RG10-07503	2 5/8" high RG10-07504	3 5/8" high RG10-07505	4 5/8" high RG10-07506	6 5/8" high RG10-07508	8 5/8" high RG10-07510
9"	1 5/8" high RG10-09003	2 5/8" high RG10-09004	3 5/8" high RG10-09005	4 5/8" high RG10-09006	6 5/8" high RG10-09008	8 5/8" high RG10-09010
10"	1 5/8" high RG10-10003	2 5/8" high RG10-10004	3 5/8" high RG10-10005	4 5/8" high RG10-10006	6 5/8" high RG10-10008	8 5/8" high RG10-10010
12"	1 5/8" high RG10-12003	2 5/8" high RG10-12004	3 5/8" high RG10-12005	4 5/8" high RG10-12006	6 5/8" high RG10-12008	8 5/8" high RG10-12010
15"	1 5/8" high RG10-15003	2 5/8" high RG10-15004	3 5/8" high RG10-15005	4 5/8" high RG10-15006	6 5/8" high RG10-15008	8 5/8" high RG10-15010

Tops

Laminated Wood Top

WS14



Made with varnished
 hardwood slats;
 90° radius front edge for
 more comfort;
 Thickness : 1 3/4";
 Attractive appearance.

Product #	W x D	Application
WS14-3621A*	36" x 21"	2 cabinets (21" deep)
WS14-3627A*	36" x 27"	2 cabinets (27" deep)
WS14-5421A*	54" x 21"	3 cabinets (21" deep)
WS14-5427A*	54" x 27"	3 cabinets (27" deep)

NOTE *Please check with your customer service representative for lead time.

Plastic Laminated Top

WS16



Color : white;
 90° radius front edge for more comfort;
 Thickness : 1 1/2";
 Attractive appearance.

Product #	W x D	Application
WS16-3621A*	36" x 21"	2 cabinets (21" deep)
WS16-3627A*	36" x 27"	2 cabinets (27" deep)
WS16-5421A*	54" x 21"	3 cabinets (21" deep)
WS16-5427A*	54" x 27"	3 cabinets (27" deep)

NOTE * Please check with your customer service representative for lead time.

Steel Top with Rubber Mat

RC32



Non-slip rubber surface;
 Sides and back formed with a double fold, 1" high.

Product #	W x D	Application
RC32-3621-01	36" x 21"	2 cabinets (21" deep)
RC32-3627-01	36" x 27"	2 cabinets (27" deep)
RC32-5421-01	54" x 21"	3 cabinets (21" deep)
RC32-5427-01	54" x 27"	3 cabinets (27" deep)



"L" Compact Cabinet Housing

LA30

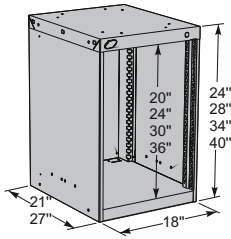

Create a customized work space with a wide range of possibilities;

Four standard heights:

- 24" (20" inside)
- 28" (24" inside)
- 34" (30" inside)
- 40" (36" inside)

Drawers, shelves and doors can be installed in the housing;

Housing is equipped with knock-outs :

- On the top: for stacking a drawer unit housing LD75 or another cabinet.
In the later case, order the LA78;
- On the sides and back: for assembling cabinets side-to-side and back-to-back.
- On the sides: for installing under the work surface. Order the RA70.

2" base can be added to make cabinet heights of 26", 30", 36" and 42";

4" base can be added to make cabinet heights of 28", 32", 38" and 44";

Lock on the housing allows user to secure all drawers at the same time, complete the product number with L3;

To order hasp for padlock, complete the product number with LP.

Product #	W x D x H	Product #	W x D x H
LA30-182124	18" x 21" x 24"	LA30-182724	18" x 27" x 24"
LA30-182128	18" x 21" x 28"	LA30-182728	18" x 27" x 28"
LA30-182134	18" x 21" x 34"	LA30-182734	18" x 27" x 34"
LA30-182140	18" x 21" x 40"	LA30-182740	18" x 27" x 40"

"L" Compact Drawer

LF31

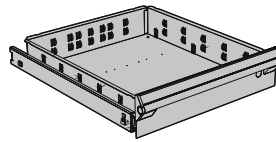

100 lb capacity, 100% extension;

Wide range of accessories available to adapt to your storage needs;

Precision ball bearing drawer slides included;

Easy hook-on assembly;

For drawer layout proposals, see pages 24-25;

Available drawer heights; 3", 4", 5", 6", 8" and 12";

For a 12" drawer: Order LG31 hanging folder bars for letter (8½" x 11") or legal size (8½" x 14") folders;

Order by adding the drawer height to the product number and by specifying the lock-in and the drawer lock. Ex.: LF31-182106B, LF31-182106L3, LF31-182106L3B.

Product #	W x D
LF31-1821	18" x 21"
LF31-1827	18" x 27"

Adjustable Shelf

LB24

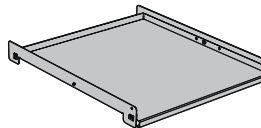

For storing larger, bulkier items;

Equipped with edges along sides and back;

Adjustable in height every 1" c/c;

Capacity up to 100 lb evenly distributed load;

2 versions of the adjustable shelf are possible depending on if the housing is equipped with a central locking mechanism;

Available in galvanized steel;

Order by adding the housing depth – 21" or 27".

Product #	For LA30
LB24-18_01	with L3/LP on the housing
LB24-18_02	without L3/LP on the housing

Integrated Door

LB30

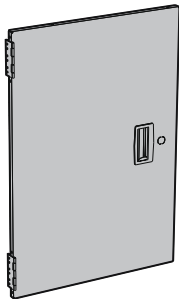

6 standard heights;

Handle fitted in plastic;

Can be installed with hinges on right or left;

Shelf LB24 must be ordered as storage surface for doors installed above a drawer or another door;

For central locking mechanism, complete the product number with L3;

For hasp for padlock, complete the product number with LP.

Product #	W x H
LB30-1812	18" x 12"
LB30-1818	18" x 18"
LB30-1820	18" x 20"
LB30-1824	18" x 24"
LB30-1830	18" x 30"
LB30-1836	18" x 36"

Security Panel

LF91

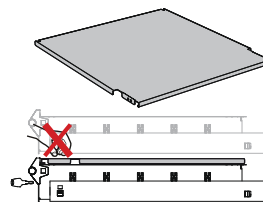

Allows for the cabinet to be divided up for more than one user;

Adjustable at every 1" c/c;

Must be ordered to:

- Block access between drawers
- Block access when a door with lock is installed under a drawer
- Block space when a door is installed above a drawer.

2 versions of the security panel are possible depending on if the housing is equipped with a central locking mechanism;

Available in galvanized steel;

Order by adding the housing depth – 21" or 27".

Product #	For LA30
LF91-18_01	with L3/LP on the housing
LF91-18_02	without L3/LP on the housing





Cabinet Base

LA85

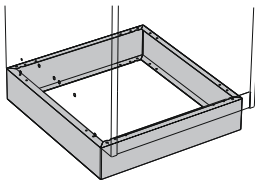

Available heights: 2" and 4";
 2" recessed clearance;
 Compatible with LA74 leveling glide kit;
 Note: not compatible with floor anchoring kit (LA76), stacking kit (LA78) and casters.

Product #	W x D x H
LA85-182102	18" x 21" x 2"
LA85-182104	18" x 21" x 4"
LA85-182702	18" x 27" x 2"
LA85-182704	18" x 27" x 4"

Drawer Unit Housing

LD75

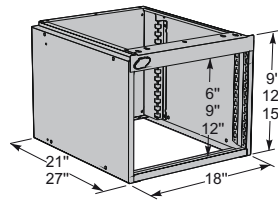

Three standard heights:
 - 9" (6" inside)
 - 12" (9" inside)
 - 15" (12" inside)

Installed on a cabinet or under a work surface;
 100 lb capacity for each drawer in the unit for a maximum of 175 lb per unit;
 Compatible with LF31 compact drawer (not included);
 Order by adding drawer unit housing depth, 21" or 27" deep.

Product #	Inside dim.
LD75-18_09	6"
LD75-18_12	9"
LD75-18_15	12"

Leveling Glide Kit

LA74

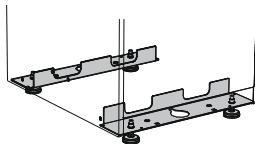

Used to stabilize a cabinet installed on an uneven surface;
 Can be installed under cabinets with or without bases;
 Includes: 2 supports and 4 leveling glides.

Product #	Width
LA74-1801	18"

Drawer Unit Cover

LD76

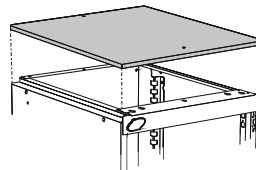

Used to cover the top of the drawer unit when installed on the work surface.

Product #	W x D
LD76-1821	18" x 21"
LD76-1827	18" x 27"

Floor Anchoring Kit

LA76

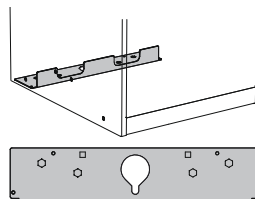

Used to anchor a cabinet (without base) to the floor;
 Includes 1 bolt for concrete floors.

Product #	Width
LA76-1801	18"

Top view

Stacking Kit

LA78

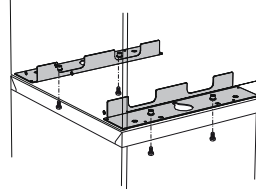

Designed for stacking two "L" compact cabinets;
 Used at the bottom of the upper cabinet;
 Includes: 2 supports and hardware for anchoring.

Product #	Width
LA78-1801	18"



L3XBD-2802L3C



L3AED-4002L3



L3XJD-2802L3

"R" Heavy-Duty Mobile Cabinet

"R" MOBILE CABINET



"R" MOBILE CABINET

The "R" mobile cabinet is one of the safest on the market. The Lock-In mechanism is activated with one hand, leaving the other free. All of this, thanks to a simple upwards tilting of the ergonomic drawer handle.

In addition, it is very easy to modify the configuration of the cabinet : drawer order can be changed at any time. Our specialists will be very pleased to assist you in adapting a cabinet specific to your needs, with a customized configuration to meet your customer's requirements.

The "R" mobile cabinet, with its industrial quality construction, is definitely one of the strongest and most durable on the market. Our Research & Development department have put the cabinet through capacity, impact and general wear and tear trials. Equipped with high-quality casters, the cabinet was designed for intensive use in hostile work environments. Its distinctive look and design (industrial design patented), make it unique.

An impressive number of accessories to complete and complement your cabinet are available. We offer a selection of five different tops, two types of handles (on the front and on the side), foldaway shelves as well as hanging side cabinets. In addition, you no longer have to worry about making future changes as your business grows and your needs evolve, with Rousseau's easy retrofit accessories.

The unique shape of the "R" drawer is a Rousseau Metal Inc. trademark.



R5XHD-3001

"R" Heavy-Duty Mobile Cabinet

The Rousseau Advantages



The integrated Lock-In mechanism is easily activated with one hand (right or left).

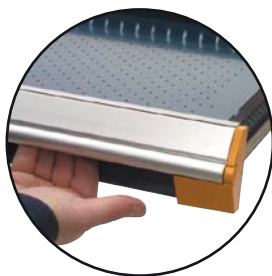

The full-width ergonomic handle ensures a smooth and comfortable motion when opening the drawer.

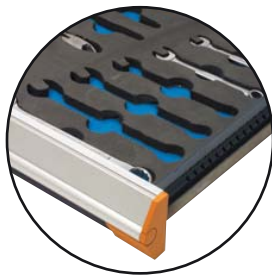

A variety of drawer accessories are available, such as : partitions, dividers, plastic bins, protective foam, etc.



Polyurethane casters with high quality roller bearing systems make moving the cabinet easy and do not leave marks. Total-lock brake available.



Several housing accessories are available such as : foldaway shelves, hanging side cabinets, laminated wood tops, etc.

General Dimensions

Available Heights

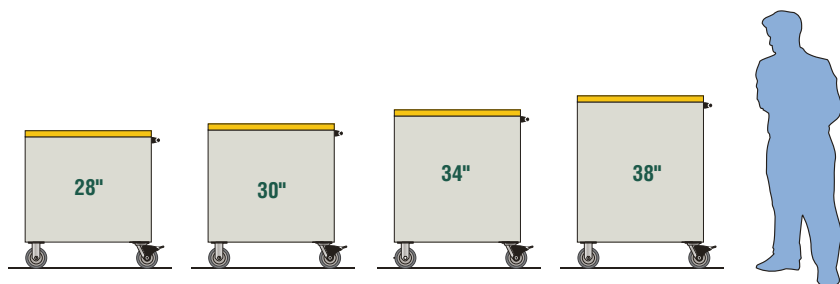

NOTE Total height indicated includes 6" casters and 1 3/4" thick top.

Index	Page(s)
"R" Heavy-Duty Mobile Cabinet	30 - 31
Proposals	32 - 35
Accessories	36 - 38
Components	39 - 42
Smart Compact Mobile "L" Cabinet	43
Proposals	44 - 45
Accessories	46 - 47
Components	48 - 49

Width x Depth

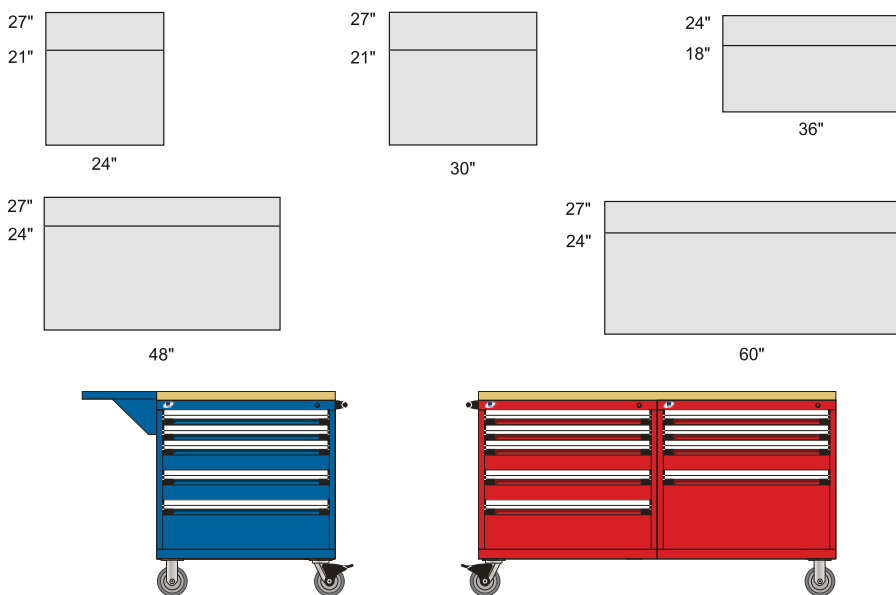

Proposals

"R" MOBILE CABINET

Shown here are several of the most popular mobile modular cabinet models.

The 24" W cabinet models include 4" casters; 2" swivel with total-lock brake system and 2 rigid. Proposals include an econo lock-in mechanism (B);

The 30", 36", 48" (2x24") and 60" (2x30") wide cabinet models include 6" casters; 2 swivel with total-lock brake system and 2 rigid. Proposals include an integrated lock-in mechanism (A);

Cabinets come with standard lock (on doors also);

To add a stainless steel, galvanized steel, painted steel, steel with rubber mat or wood top,

All models are factory assembled and ready to use. Doors are installed with hinges on the right side. However, they can be installed on the left upon request.

SEE PAGE 40

SEE PAGE 38

IMPORTANT

Drawer partitions are included in models.

NOTE

For drawers without partitioning, complete the even number following the last two digits of the model.

Ex. : R5BCD-2801 with R5BCD-2802 without

To prevent the mobile cabinet from tipping, distribute the load evenly.

SEE PAGE 188
KA, KD or MK

Number of Compartments (layout code)	24" x 21"	24" x 27"	30" x 21"	30" x 27"	36" x 18"	36" x 24"	48" x 24"	48" x 27"	60" x 24"	60" x 27"
3" to 5"	12 (0308)	20 (0316)	24 (0518)	25 (0420)	24 (0518)	30 (0524)	40 (0732)	32 (0724)	70 (1356)	84 (1370)
6" to 8"	9 (0206)	12 (0209)	12 (0308)	12 (0308)	8 (0304)	12 (0308)	15 (0410)	15 (0410)	24 (0716)	21 (0614)
9" and higher	4 (0102)	6 (0104)	6 (0203)	9 (0206)	6 (0203)	9 (0206)	8 (0304)	8 (0304)	12 (0308)	12 (0308)

NOTE For inside drawer dimensions. SEE PAGES 134-135

24" Wide

Each model includes two front handles.



4 drawers
R5BCD-2801 24" x 21" x 33 1/4"
R5BCG-2801 24" x 27" x 33 1/4"



4 drawers
R5BCD-2803 24" x 21" x 33 1/4"
R5BCG-2803 24" x 27" x 33 1/4"



3 drawers
R5BCD-2805 24" x 21" x 33 1/4"
R5BCG-2805 24" x 27" x 33 1/4"



6 drawers
R5BCD-3051 24" x 21" x 35 1/4"
R5BCG-3051 24" x 27" x 35 1/4"



5 drawers
R5BCD-3053 24" x 21" x 35 1/4"
R5BCG-3053 24" x 27" x 35 1/4"



5 drawers
R5BCD-3055 24" x 21" x 35 1/4"
R5BCG-3055 24" x 27" x 35 1/4"



5 drawers
R5BCD-3401 24" x 21" x 39 1/4"
R5BCG-3401 24" x 27" x 39 1/4"



7 drawers
R5BCD-3851 24" x 21" x 43 1/4"
R5BCG-3851 24" x 27" x 43 1/4"

30" and 36" Wide

Each model includes one side handle.



1 drawer / 1 door / 1 bottom shelf

R5BDD-2801	30" x 21" x 35 1/2"
R5BDG-2801	30" x 27" x 35 1/2"
R5BEC-2801	36" x 18" x 35 1/2"
R5BEE-2801	36" x 24" x 35 1/2"



4 drawers

R5BDD-2803	30" x 21" x 35 1/2"
R5BDG-2803	30" x 27" x 35 1/2"
R5BEC-2803	36" x 18" x 35 1/2"
R5BEE-2803	36" x 24" x 35 1/2"



6 drawers

R5BDD-3001	30" x 21" x 37 1/2"
R5BDG-3001	30" x 27" x 37 1/2"
R5BEC-3001	36" x 18" x 37 1/2"
R5BEE-3001	36" x 24" x 37 1/2"



5 drawers

R5BDD-3003	30" x 21" x 37 1/2"
R5BDG-3003	30" x 27" x 37 1/2"
R5BEC-3003	36" x 18" x 37 1/2"
R5BEE-3003	36" x 24" x 37 1/2"



5 drawers

R5BDD-3005	30" x 21" x 37 1/2"
R5BDG-3005	30" x 27" x 37 1/2"
R5BEC-3005	36" x 18" x 37 1/2"
R5BEE-3005	36" x 24" x 37 1/2"



6 drawers

R5BDD-3007	30" x 21" x 37 1/2"
R5BDG-3007	30" x 27" x 37 1/2"
R5BEC-3007	36" x 18" x 37 1/2"
R5BEE-3007	36" x 24" x 37 1/2"



1 roll-out shelf / 1 door / 1 bottom shelf

R5BDD-3012	30" x 21" x 37 1/2"
R5BDG-3012	30" x 27" x 37 1/2"
R5BEC-3012	36" x 18" x 37 1/2"
R5BEE-3012	36" x 24" x 37 1/2"



1 door / 1 adjustable shelf / 1 bottom shelf

R5BDD-3014	30" x 21" x 37 1/2"
R5BDG-3014	30" x 27" x 37 1/2"
R5BEC-3014	36" x 18" x 37 1/2"
R5BEE-3014	36" x 24" x 37 1/2"



1 roll-out shelf / 4 drawers

R5BDD-3015	30" x 21" x 37 1/2"
R5BDG-3015	30" x 27" x 37 1/2"
R5BEC-3015	36" x 18" x 37 1/2"
R5BEE-3015	36" x 24" x 37 1/2"

Proposals

"R" MOBILE CABINET



7 drawers

R5BDD-3801	30" x 21" x 45 1/2"
R5BDG-3801	30" x 27" x 45 1/2"
R5BEC-3801	36" x 18" x 45 1/2"
R5BEE-3801	36" x 24" x 45 1/2"



7 drawers

R5BDD-3803	30" x 21" x 45 1/2"
R5BDG-3803	30" x 27" x 45 1/2"
R5BEC-3803	36" x 18" x 45 1/2"
R5BEE-3803	36" x 24" x 45 1/2"



4 drawers / 1 door / 1 bottom shelf

R5BDD-3805	30" x 21" x 45 1/2"
R5BDG-3805	30" x 27" x 45 1/2"
R5BEC-3805	36" x 18" x 45 1/2"
R5BEE-3805	36" x 24" x 45 1/2"

48" and 60" Wide

Each model includes one side handle.



6 drawers

R5BHE-3001	48" x 24" x 37 1/2"
R5BHG-3001	48" x 27" x 37 1/2"
R5BKE-3001	60" x 24" x 37 1/2"
R5BKG-3001	60" x 27" x 37 1/2"



5 drawers

R5BHE-3003	48" x 24" x 37 1/2"
R5BHG-3003	48" x 27" x 37 1/2"
R5BKE-3003	60" x 24" x 37 1/2"
R5BKG-3003	60" x 27" x 37 1/2"



5 drawers

R5BHE-3009	48" x 24" x 37 1/2"
R5BHG-3009	48" x 27" x 37 1/2"
R5BKE-3009	60" x 24" x 37 1/2"
R5BKG-3009	60" x 27" x 37 1/2"



5 drawers

R5BHE-3011	48" x 24" x 37 1/2"
R5BHG-3011	48" x 27" x 37 1/2"
R5BKE-3011	60" x 24" x 37 1/2"
R5BKG-3011	60" x 27" x 37 1/2"



1 drawer / 1 double door / 1 bottom shelf

R5BHE-3013	48" x 24" x 37 1/2"
R5BHG-3013	48" x 27" x 37 1/2"
R5BKE-3013	60" x 24" x 37 1/2"
R5BKG-3013	60" x 27" x 37 1/2"



1 roll-out shelf / 4 drawers

R5BHE-3015	48" x 24" x 37 1/2"
R5BHG-3015	48" x 27" x 37 1/2"
R5BKE-3015	60" x 24" x 37 1/2"
R5BKG-3015	60" x 27" x 37 1/2"

48" and 60" Wide (2 x 24" and 2 x 30")

Each cabinet includes one side handle and one brace to attach the cabinets.



12 drawers

R5DHG-3001	48" x 27" x 37 1/2"
R5DKG-3001	60" x 27" x 37 1/2"



5 drawers / 1 door / 1 bottom shelf

R5DHG-3007	48" x 27" x 37 1/2"
R5DKG-3007	60" x 27" x 37 1/2"



8 drawers / 1 roll-out shelf

R5DHG-3009	48" x 27" x 37 1/2"
R5DKG-3009	60" x 27" x 37 1/2"



8 drawers / 1 door / 1 adjustable shelf / 1 bottom shelf

R5DHG-3801	48" x 27" x 45 1/2"
R5DKG-3801	60" x 27" x 45 1/2"



7 drawers / 1 door / 1 bottom shelf

R5DHG-3803	48" x 27" x 45 1/2"
R5DKG-3803	60" x 27" x 45 1/2"



10 drawers

R5DHG-3807	48" x 27" x 45 1/2"
R5DKG-3807	60" x 27" x 45 1/2"



Accessories

"R" MOBILE CABINET

Security Accessories and Recommendations

Vertical Security Bar

RB10



Lock all of the cabinet drawers with one padlock;
Safety hasp is located at the top of the bar to facilitate access;
Available to cover overall drawer heights from 24" to 34";
Can be installed on the right.

Product #	Height
RB10-24 LPA	24"
RB10-26 LPA	26"
RB10-30 LPA	30"
RB10-34 LPA	34"

Security Panel

RF91

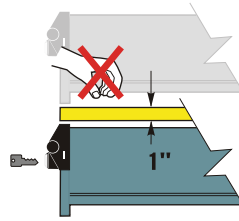

Blocks access between two drawers with locks;
Usable space in cabinet reduced by 1";
Installed between two drawers;
Allows for the cabinet to be divided up for more than one user;
Order by specifying the width and dept.
Ex. : RF91-36 24 for a 36" W x 24" D security panel.

Product #
RF91-_____

Cabinet Lock



L3



Allows user to lock all drawers and roll-out shelves in the cabinet at same time;
Possible to change drawer and roll-out shelf positions;
Easy to retrofit;
Order by adding L3 to the cabinet housing number. Ex. : RA30-302758L3.

Product #
L3

True One-Drawer-at-a-Time System **PATENTED** RB15

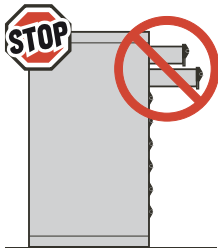

Prevents opening several drawers simultaneously. This ensures cabinet stability and protects the users;

To retrofit this mechanism, order RB15-XX-XX; for factory installation, add A to the cabinet housing number;

SEE PAGE 39

One kit per cabinet.

Product #	Cabinet Height
RB15-28-08	28"
RB15-30-08	30"
RB15-34-10	34"
RB15-38-11	38"



Recommended for mobile cabinets and cabinets not anchored to the floor.

Cabinet Safety Hasp

LP



Allows user to lock all drawers and roll-out shelves in the cabinet at the same time;
Possible to change drawer and roll-out shelf positions;
Alternative to the RB10 vertical security bar;
Easy to retrofit;
Order by adding LP to the cabinet housing number. Ex. : RA30-302758LP.

Product #
LP

Double Mobile Cabinet : Appropriate Combination

In order to determine the appropriate cabinet combination, ask yourself the following questions: What is the desired cabinet width and what is the desired capacity? Here are the possibilities :

Standard Double Cabinet

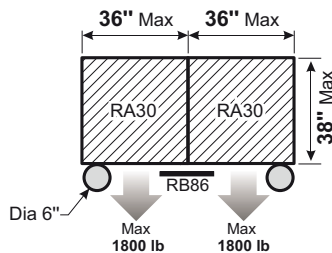

Maximum width of 72";
Total capacity : 3600 lbs. (1800 lbs. each side);
Comes with pair of braces;
2 pairs of 6" casters.

Double Cabinet

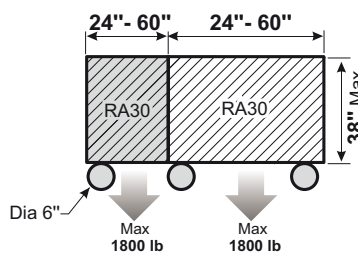

Maximum width of 120";
Total capacity : 3600 lb (1800 lbs. each side);
3 pairs of 6" casters.

Side Cabinet

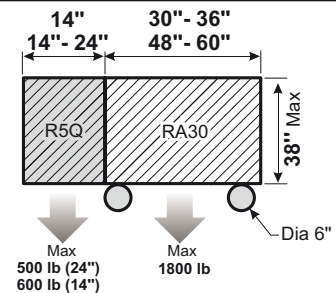

Maximum width of 84";
Total capacity : 2300 or 2400 lbs. total;
2 pairs of 6" casters;
Note : RF31/RF40 and RF44 are not available for the side cabinet.



The height of the cabinet should not exceed 38" in order to assure cabinet stability when it is moved.

Hanging Side Cabinet

Hanging Side Cabinet - Side Access

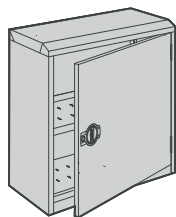

Side housing specifically designed to be installed on the side of RA30 cabinet housing;

Includes one bottom shelf;

Shelves adjustable every 1" c/c;

SH52 dividers can be installed on shelves;

Equipped with holes on the top to allow installation between one common work surface to a RA30 cabinet;

Door opens 180° for full access to items stored inside;

Door comes with standard lock;

Capacity : 600 lb;

Choice of doors. Complete the product number from the chart with the following :

01 : solid door

02 : glass door



Height	Width x Depth		Number of (RD05) Adjustable Shelves
	24" x 14"	27" x 14"	
24"	R5QCA-24	R5QPA-24	-
28"	R5QCA-28	R5QPA-28	1
30"	R5QCA-30	R5QPA-30	1
34"	R5QCA-34	R5QPA-34	1
38"	R5QCA-38	R5QPA-38	2
For cabinet	24" D	27" D	



R5XHE-1001

NOTE

For compatibility with a work surface, choose the part number of a work surface 12" wider than your cabinet. Ex.: RC -4824 for a mobile 36" W x 24" D cabinet.

Hanging Side Cabinet - Front Access

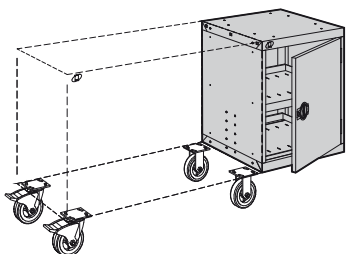

Side cabinet designed to be installed on the side of RA30 cabinet housing;

The shelves are adjustable at every 1" c/c;

SH52 dividers can be installed on both bottom and adjustable shelves;

The roll-out shelf has a capacity of 175 lb, 75% extension;

Equipped with holes on the top to allow installation between one common work surface to a RA30 cabinet;

Door opens 180°, allowing clearance space for easy handling of objects in the cabinet;

Door comes with standard lock;

Capacity : 500 lb ;

Choice of configurations. Complete the number:

Bottom shelf and adjustable shelf(ves)

03 : Solid door

05 : Glass door

Roll-out shelves

04 : Solid door

06 : Glass door

NOTE

For compatibility with a work surface, choose the part number of a work surface 24" wider than your cabinet.

Ex.: RC -7224 for a mobile 48" W x 24" D cabinet.

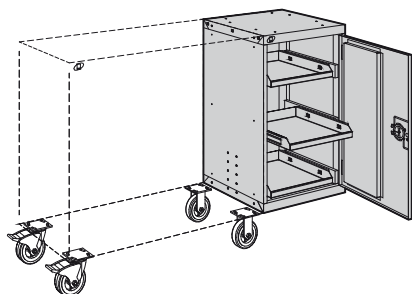

R5XRE-3001

Height	Width x Depth			Number of (RB22) Adjustable Shelves	Number of (RF50) Roll-Out Shelves
	24" x 18"	24" x 21"	24" x 24"		
28"	R5QCC-28	R5QCD-28	R5QCE-28	1	2
30"	R5QCC-30	R5QCD-30	R5QCE-30	1	2
34"	R5QCC-34	R5QCD-34	R5QCE-34	1	2
38"	R5QCC-38	R5QCD-38	R5QCE-38	2	3
For cabinet	18" D	21" D	24" D		



It is recommended to install this product on a 48" or wider.

Accessories

Cabinet Tops

Steel Top with Rubber Mat

RC32



Non-slip rubber surface;
Sides and back formed with a double fold : 1" high.

Product #	W x D x H
RC32-2421-01	24" x 21" x 1"
RC32-2427-01	24" x 27" x 1"
RC32-3021-01	30" x 21" x 1"
RC32-3027-01	30" x 27" x 1"
RC32-3618-01	36" x 18" x 1"
RC32-3624-01	36" x 24" x 1"
RC32-4227-01	42" x 27" x 1"

Product #	W x D x H
RC32-4824-01	48" x 24" x 1"
RC32-4827-01	48" x 27" x 1"
RC32-6024-01	60" x 24" x 1"
RC32-6027-01	60" x 27" x 1"
RC32-7224-01	72" x 24" x 1"
RC32-7227-01	72" x 27" x 1"

Stainless Steel Top

RC35



Serves as a work surface and protects the cabinet against impacts;
Particle board top with stainless steel cover (brushed finish #4);
Excellent corrosion and chemical resistance;
The top respects the CARB regulations on formaldehyde emissions;
Welded corners for attractive look.

Product #	W x D x H
RC35-3027	30" x 27" x 1 3/4"
RC35-3624	36" x 24" x 1 3/4"
RC35-4824	48" x 24" x 1 3/4"
RC35-4827	48" x 27" x 1 3/4"

Product #	W x D x H
RC35-6024	60" x 24" x 1 3/4"
RC35-6027	60" x 27" x 1 3/4"
RC35-7224	72" x 24" x 1 3/4"

Painted Steel Top

RC37



Serves as a work surface and protects cabinet against impacts;
Composite wood top with painted steel covers;
The top respects the CARB regulations on formaldehyde emissions;
Welded corners for attractive look;

Product #	W x D x H
RC37-3027	30" x 27" x 1 3/4"
RC37-3624	36" x 24" x 1 3/4"
RC37-4227	42" x 27" x 1 3/4"
RC37-4824	48" x 24" x 1 3/4"
RC37-4827	48" x 27" x 1 3/4"

Product #	W x D x H
RC37-6024	60" x 24" x 1 3/4"
RC37-6027	60" x 27" x 1 3/4"
RC37-7224	72" x 24" x 1 3/4"
RC37-7227	72" x 27" x 1 3/4"

NOTE

For compatibility with hanging side cabinet, choose top that is 12" wider than your cabinet for hanging side cabinet-side access, and 24" wider than your cabinet for hanging side cabinet-front access. Ex. : RC_-4824 for a mobile 36" W x 24" D cabinet combined with a cabinet-side access : 36" + 12" = 48".

Foldaway Shelf

RC00

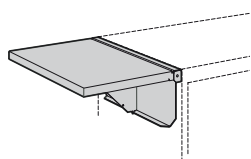

Capacity : 50 lb (evenly distributed load);
Rubber mat surface for added protection;
RC01 side stops can be installed as an option.

Product #	W x D
RC00-151801	15" x 18"
RC00-152101	15" x 21"
RC00-152401	15" x 24"
RC00-152701	15" x 27"

Laminated Wood Top

WS14



Made from strips of laminated hardwood;
Front 90° rounded edge for added comfort;
Good impact resistance;
Attractive appearance.

NOTE * Please check with your customer service representative for lead time.

Product #	W x D x H
WS14-3027A*	30" x 27" x 1 3/4"
WS14-3624A	36" x 24" x 1 3/4"
WS14-4227A*	42" x 27" x 1 3/4"
WS14-4824A*	48" x 24" x 1 3/4"
WS14-4827A*	48" x 27" x 1 3/4"

Product #	W x D x H
WS14-6024A*	60" x 24" x 1 3/4"
WS14-6027A*	60" x 27" x 1 3/4"
WS14-7224A	72" x 24" x 1 3/4"
WS14-7227A*	72" x 27" x 1 3/4"

Galvanized Steel Top

RC36



Serves as a work surface and protects the cabinet against impacts;
Particle board top with galvanized cover;
The top respects the CARB regulations on formaldehyde emissions.

Product #	W x D x H
RC36-3027	30" x 27" x 1 3/4"
RC36-3624	36" x 24" x 1 3/4"
RC36-4227	42" x 27" x 1 3/4"
RC36-4824	48" x 24" x 1 3/4"
RC36-4827	48" x 27" x 1 3/4"

Product #	W x D x H
RC36-6024	60" x 24" x 1 3/4"
RC36-6027	60" x 27" x 1 3/4"
RC36-7224	72" x 24" x 1 3/4"
RC36-7227	72" x 27" x 1 3/4"

Back and Side Stops

WS18 / WS98

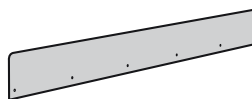

Painted steel : WS18;
Stainless steel : WS98;
Can be attached to back or sides according to top dimensions;
Install on WS14, RC35, RC36 and RC37 tops;
Height : 5". Exceeds top by approx. 3 1/4";
To order, complete the part # with steel choice needed.

Product #	Length
WS_-2405	24"
WS_-2705	27"
WS_-3005	30"
WS_-3605	36"

Product #	Length
WS_-4205	42"
WS_-4805	48"
WS_-6005	60"
WS_-7205	72"

Side and Back Stops for Foldaway Shelf

RC01

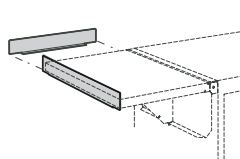

Use 15" side stop for front and back of shelf;
Use 18", 21", 24" or 27" side stop for the sides;
Height : 1".

Product #	Width
RC01-15	15"
RC01-18	18"
RC01-21	21"
RC01-24	24"
RC01-27	27"

Housings

"R" Heavy-Duty Cabinet Housing

RA30

Select the best solution from our wide range of possibilities to create your custom storage or work space.

Modular drawers, roll-out shelves, adjustable and bottom shelves can be installed;

Compatible with integrated doors;

Housings are fitted with knock-outs :

- on the top of the housing for attaching accessories or work surfaces
- on the sides and back for attaching accessories

To order a cabinet lock, complete the product number with L3;

For a safety hasp, complete the product number with LP;

To order a true one-drawer-at-a-time mechanism, complete the product number with A.

NOTE To allow user to lock all drawers and roll-out shelves in the cabinet at same time, complete product number with L3.

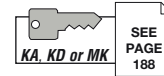

24" and 30" Wide

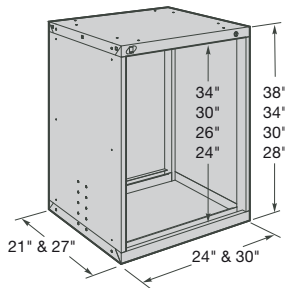

36" Wide

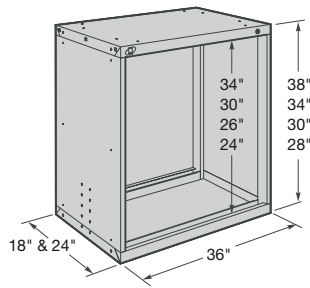

48" and 60" Wide

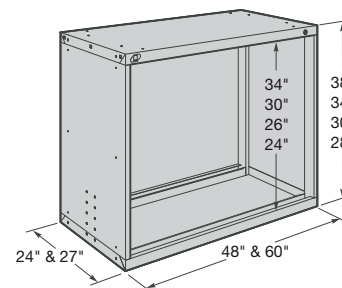

Product #	Total Height	Inside Height
24" x 21"		
RA30-242128	28"	24"
RA30-242130	30"	26"
RA30-242134	34"	30"
RA30-242138	38"	34"

Product #	Total Height	Inside Height
24" x 27"		
RA30-242728	28"	24"
RA30-242730	30"	26"
RA30-242734	34"	30"
RA30-242738	38"	34"

Product #	Total Height	Inside Height
30" x 21"		
RA30-302128	28"	24"
RA30-302130	30"	26"
RA30-302134	34"	30"
RA30-302138	38"	34"

Product #	Total Height	Inside Height
30" x 27"		
RA30-302728	28"	24"
RA30-302730	30"	26"
RA30-302734	34"	30"
RA30-302738	38"	34"

Product #	Total Height	Inside Height
36" x 18"		
RA30-361828	28"	24"
RA30-361830	30"	26"
RA30-361834	34"	30"
RA30-361838	38"	34"

Product #	Total Height	Inside Height
36" x 24"		
RA30-362428	28"	24"
RA30-362430	30"	26"
RA30-362434	34"	30"
RA30-362438	38"	34"

Product #	Total Height	Inside Height
48" x 24"		
RA30-482428	28"	24"
RA30-482430	30"	26"
RA30-482434	34"	30"
RA30-482438	38"	34"

Product #	Total Height	Inside Height
48" x 27"		
RA30-482728	28"	24"
RA30-482730	30"	26"
RA30-482734	34"	30"
RA30-482738	38"	34"

Product #	Total Height	Inside Height
60" x 24"		
RA30-602428	28"	24"
RA30-602430	30"	26"
RA30-602434	34"	30"
RA30-602438	38"	34"

Product #	Total Height	Inside Height
60" x 27"		
RA30-602728	28"	24"
RA30-602730	30"	26"
RA30-602734	34"	30"
RA30-602738	38"	34"



Braces for Double Mobile Cabinet

RB86

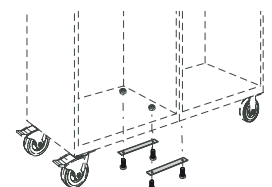

Come in pairs;

Attach two housings together, 36" wide and under, to form a double mobile cabinet;

All the cabinet tops on page 38 are compatible with double cabinets;

Cabinets are factory installed.

Product #

RB86-01

Components

Drawers, Roll-out Shelves and Locking or Security Mechanisms

"R" MOBILE CABINET

Heavy-Duty Modular Drawer for Cabinet

RF31



400 lb capacity, 100% extension;
Heavy-duty construction;
Easy to install;

Vast choice of accessories offered to adapt to your storage needs;
Available drawer heights : 3", 4", 5", 6", 7", 8", 9", 10", 12" and 14";

Order by adding the height of the drawer to the number and by specifying the type of locking mechanism required. Ex. : RF31-362406A;

For modular drawers with layouts.

SEE PAGES 151-155

SEE PAGES 137-150

A lock-in mechanism (A or B) is mandatory for all mobile applications.

Product #	W x D
RF31-2421	24" x 21"
RF31-2427	24" x 27"
RF31-3021	30" x 21"
RF31-3027	30" x 27"
RF31-3618	36" x 18"
RF31-3624	36" x 24"

Product #	W x D
RF31-4824	48" x 24"
RF31-4827	48" x 27"
RF31-6024	60" x 24"
RF31-6027	60" x 27"

Heavy-Duty 3-Sided Access Roll-Out Shelf

RF44



400 lb capacity, 100% extension;
Heavy-duty construction;
Easy to install;
Galvanized steel with 1 1/2" edge on back;
Height : 5";

May serve as work surface;
Order by specifying the type of locking mechanism required. Ex. : RF44-3624A.

Product #	W x D
RF44-2421	24" x 21"
RF44-2427	24" x 27"
RF44-3021	30" x 21"
RF44-3027	30" x 27"
RF44-3618	36" x 18"
RF44-3624	36" x 24"

Product #	W x D
RF44-4824	48" x 24"
RF44-4827	48" x 27"
RF44-6024	60" x 24"
RF44-6027	60" x 27"

Drawer Lock



L3

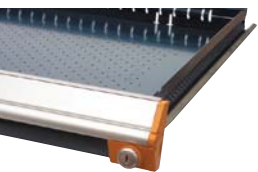

Compatible with all drawer dimensions;
Does not affect usable drawer space;
Easy to retrofit;

Order by adding L3 to drawer or partitioning model number.
Ex. : RF31-362406L3.

Product #
L3

KA, KD or MK
SEE PAGE 188

Lock-Out Mechanism

RF85



For both drawers and roll-out shelves;
Locks drawers and roll-out shelves in open position;
Activated manually, only when required;
No interference with drawer accessories.

Product #
RF85

Heavy-Duty Front Access Roll-Out Shelf

RF40



400 lb capacity, 100% extension;
Heavy-duty construction;
Easy to install;
Painted steel with 3" edges on sides and back;
Height : 6";
Full access to contents;

Order by specifying the type of locking mechanism required. Ex. : RF40-3624A.

Product #	W x D
RF40-2421	24" x 21"
RF40-2427	24" x 27"
RF40-3021	30" x 21"
RF40-3027	30" x 27"
RF40-3618	36" x 18"
RF40-3624	36" x 24"

Product #	W x D
RF40-4824	48" x 24"
RF40-4827	48" x 27"
RF40-6024	60" x 24"
RF40-6027	60" x 27"

Integrated Lock-In Mechanism



A



Activated by tilting the handle up;
Allows user to open the drawer and the roll-out shelf with one hand only;
Close by simply pushing it;
Stops drawer and roll-out shelf from opening on their own;
Easy to retrofit;
Order by adding A to the drawer or partitioning model number or roll-out shelf.
Ex. : RF31-362406A.

Product #
A

Econo Lock-In Mechanism

B

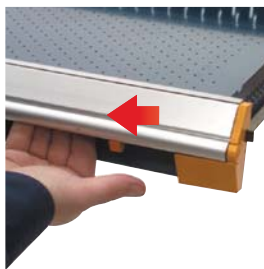

Activated with the right hand by sliding the mechanism with thumb;
Drawer and roll-out shelf close without having to reactivate the slide mechanism;
Stops drawer and roll-out shelf from opening on their own;
Easy to retrofit;
Order by adding B to the drawer or partitioning model number or roll-out shelf.
Ex. : RF31-362406B.

Product #
B

Handle Protector

RF70



Clips onto the drawer and roll-out shelf handle;
Made of transparent plastic;
Protects identification labels on drawers and roll-out shelves from dust, grease and other debris;
Easy to remove when required.

Product #	Width
RF70-24	24"
RF70-30	30"
RF70-36	36"
RF70-48	48"
RF70-60	60"

Adjustable Shelf

RB22 / RB24

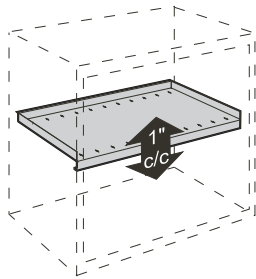

For storing bulky items;
Has edges along the sides and back to prevent items from falling into the bottom of the cabinet;
Adjustable every 1" c/c;
Up to 400 lb capacity of evenly distributed load;
SH52 dividers can be installed.

SEE PAGE 15

Product #	W x D	Capacity*
RB22-2421	24" x 21"	200
RB22-2427	24" x 27"	200
RB24-3021	30" x 21"	400
RB24-3027	30" x 27"	400
RB24-3618	36" x 18"	400
RB24-3624	36" x 24"	400
RB24-4824	48" x 24"	400
RB24-4827	48" x 27"	400
RB24-6024	60" x 24"	400
RB24-6027	60" x 27"	400

* in pounds

Bottom Shelf

RB23 / RB25

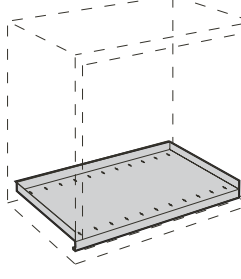

For storing bulky items;
Has edges along the sides and back to prevent items from falling into the bottom of the cabinet;
Up to 400 lb capacity of evenly distributed load;
SH52 dividers can be installed.

SEE PAGE 15

Product #	W x D	Capacity*
RB23-2421	24" x 21"	200
RB23-2427	24" x 27"	200
RB25-3021	30" x 21"	400
RB25-3027	30" x 27"	400
RB25-3618	36" x 18"	400
RB25-3624	36" x 24"	400
RB25-4824	48" x 24"	400
RB25-4827	48" x 27"	400
RB25-6024	60" x 24"	400
RB25-6027	60" x 27"	400

* in pounds

NOTE

* For compatibility with double integrated doors, order an adjustable shelf.

Mobility

4" Casters



RB81



Sold in pairs;
Choice of 3 types of casters: rigid, swivel, swivel with total-lock brake system (on wheel and swivel);
Capacity : 420 lb per caster;
Total height : 5 1/4";
Polyurethane casters (do not mark floors). Superior quality industrial casters;
Install directly under cabinet without base.

Product #	Type of Caster
RB81-01	Rigid
RB81-02	Swivel
RB81-03	Swivel with total-lock brake system

6" Casters



RB84



Sold in pairs;
Choice of 3 types of casters : rigid, swivel, swivel with total-lock brake system (on wheel and swivel);
Capacity : 900 lb per caster;
Total height : 7 1/2";
Polyurethane casters (do not mark floors). Superior quality industrial casters;
Install directly under cabinet without base.

Product #	Type of Caster
RB84-01	Rigid
RB84-02	Swivel
RB84-03	Swivel with total-lock brake system

Extended Base for Casters

RB88

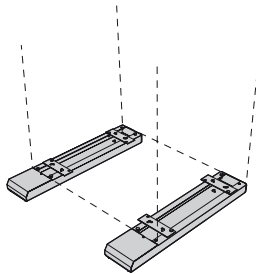

Assures cabinet stability when there are less than 4 drawers and / or when the cabinet load is not equally distributed. (Ex. : 1 drawer with 400 lbs. and 3 others with 50 lbs.);
Compatible with 4" and 6" casters.

Product #	Depth
RB88-18-05	18"
RB88-21-05	21"
RB88-24-05	24"
RB88-27-05	27"

Side Handle

RB90

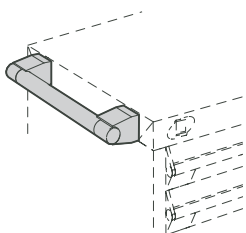

Attaches to the side of single or double cabinets : specify which side (left or right);
Anodized aluminum with durable plastic end caps;
Large handle to make moving cabinet easier.

Product #	Handle Depth	For Cabinet
RB90-18	15"	18" D
RB90-21	18"	21" D
RB90-24	21"	24" D
RB90-27	24"	27" D

6" Mag Casters



RB85



Sold in pairs
Choice of 3 types of casters: rigid, swivel, swivel with total-lock brake system (on wheel and swivel);
Aluminium wheel with durable chrome plating;
Capacity: 1000 lb per caster;
Total height: 7 1/2";
Polyurethane casters (do not mark floors). Superior quality industrial casters;
Install directly under cabinet without base.

Product #	Type of Caster
RB85-01	Rigid
RB85-02	Swivel
RB85-03	Swivel with total-lock brake system

Front Handles

RB92

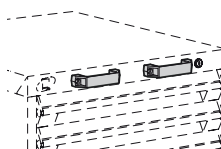

Sold in pairs;
Attach to the front of single 24" or 30" wide cabinets;
Durable plastic.

Product #
RB92-01

Components

Doors

Single Integrated Door, Solid or Glass

RB30 / RB31

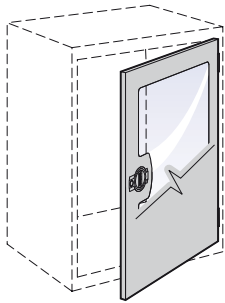

Integrated door : RB30;
 Glass integrated door : RB31;
 Single door for 24", 30" and 36" wide cabinets;
 Compatible with RB23/RB25 bottom shelf and RB22/RB24 adjustable shelf;
 Opens 180° for full access to items stored inside;
 Factory installed on RA30 cabinet housings;
 Standard lock included;
 To receive a safety hasp instead of a standard lock, replace L3 by LP in the product #;
 Some heights may be combined with drawers mounted above or below. In the latter case, you must order a RB22/RB24 adjustable shelf for installation above the section of drawers;
 Glass door made of impact resistant polycarbonate;
 Order by specifying the type of door.
 Ex. : RB31-3034L3 for a 30" W x 34" H single integrated glass door;
 Note : Not compatible with RF31 drawer or RF40/RF44 roll-out shelf.

Product #	W x H
RB_-2420L3	24" x 20"
RB_-2424L3	24" x 24"
RB_-2426L3	24" x 26"
RB_-2430L3	24" x 30"
RB_-2434L3	24" x 34"
RB_-3020L3	30" x 20"
RB_-3024L3	30" x 24"
RB_-3026L3	30" x 26"
RB_-3030L3	30" x 30"
RB_-3034L3	30" x 34"
RB_-3620L3	36" x 20"
RB_-3624L3	36" x 24"
RB_-3626L3	36" x 26"
RB_-3630L3	36" x 30"
RB_-3634L3	36" x 34"

Double Integrated Doors, Solid or Glass

RB35 / RB36

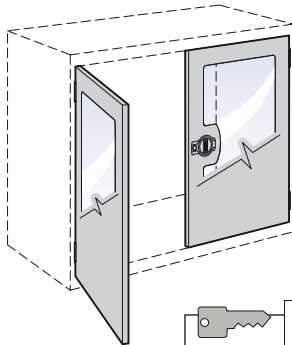

Integrated doors : RB35;
 Glass integrated doors : RB36;
 Double doors for 30", 36", 48" and 60" wide cabinets;
 Compatible with RB24 adjustable shelf;
 Opens 180° for full access to items stored inside;
 Factory installed on RA30 cabinet housings;
 Standard lock included;
 To receive a safety hasp instead of a standard lock, replace L3 by LP in the product #;
 Some heights may be combined with drawers mounted above or below. In the latter case, you must order a RB24 adjustable shelf for installation above the section of drawers, or a crossbar (RB70) for drawers mounted above;
 Glass door made of impact resistant polycarbonate;
 Order by specifying the type of door.
 Example : RB36-4820L3 for 48" W x 20" H double integrated glass doors;
 Note : Not compatible with RF31 drawer or RF40/RF44 roll-out shelf;
 Note : Not compatible with RB25 bottom shelf.

Product #	W x H
RB_-3020L3	30" x 20"
RB_-3024L3	30" x 24"
RB_-3026L3	30" x 26"
RB_-3030L3	30" x 30"
RB_-3034L3	30" x 34"
RB_-3620L3	36" x 20"
RB_-3624L3	36" x 24"
RB_-3626L3	36" x 26"
RB_-3630L3	36" x 30"
RB_-3634L3	36" x 34"
RB_-4820L3	48" x 20"
RB_-4824L3	48" x 24"
RB_-4826L3	48" x 26"
RB_-4830L3	48" x 30"
RB_-4834L3	48" x 34"
RB_-6020L3	60" x 20"
RB_-6024L3	60" x 24"
RB_-6026L3	60" x 26"
RB_-6030L3	60" x 30"
RB_-6034L3	60" x 34"

Crossbar for Double Integrated Doors

RB70

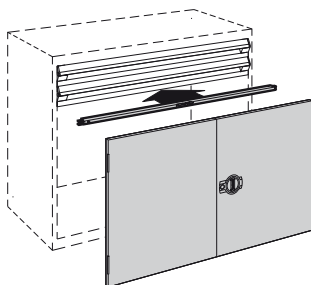

Required for double integrated doors with drawers above.

Product #	Width
RB70-30	30"
RB70-36	36"
RB70-48	48"
RB70-60	60"

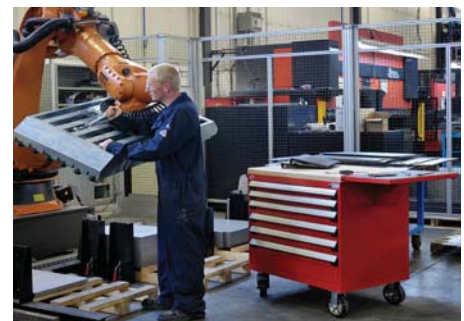



Smart Compact Mobile "L" Cabinet

"L" MOBILE CABINET



The Rousseau Advantages



100 lb capacity per drawer.
100% drawer extension in both drawer depths.
6 drawer heights available: 3", 4", 5", 6", 8" and 12".

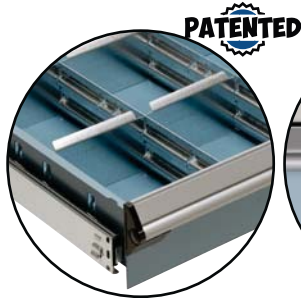

Variety of drawer accessories available: full-depth partitions, dividers, plastic bins, hanging file holder, foam for protection, etc.



Central lock on the cabinet housing.



Lock-In Mechanism. Stops drawers from opening on their own.



Polyurethane casters with high quality roller bearing system, making moving the cabinet easy. Total-lock brake system available.



L3BED-3424L3

SMART COMPACT MOBILE "L" CABINET

With an innovative design, the new Smart Compact Mobile "L" Cabinet is available in 18" wide, two depths: 21" and 27" and four different heights available ; 24", 28", 34" and 40", it adapts perfectly to your needs and is easily integrated into your work space. It can be used on its' own or in a double or triple version, with its premiere quality casters of 4" and 6" the Smart Compact Mobile "L" Cabinet is truly a solid and reliable tool!

The compact "L" drawer has a wide range of accessories available, a 100 lb storage capacity per drawer and opens 100% in both depths. The Lock-In mechanism for the drawers ensures user security, while a central locking mechanism allows the user to lock all of the drawers at the same time and secure stored materials.

With its thoughtful design, the Smart Compact Mobile "L" Cabinet is versatile, modular and ingenious! It's also an excellent alternative to the "R" Heavy-Duty version.

Proposals



Here are some examples of smart compact mobile "L" cabinets proposals:

Models are factory installed and ready for use. Doors are factory installed with hinges on the left. Hinges can be installed on the right upon request;

Models include 4" casters; 2 rigid and 2 swivel with total brake;

To add a top, see page 47;

To order a lock on the cabinet housing (for models with more than one drawer) or on the door, add L3 to the end of the product number;

The lock-in mechanism prevents drawers from opening when moving the cabinet without the central locking mechanism activated. To order, complete the product number with B. Ex.: L3BBD-2401L3B for a cabinet 18" x 21" x 29 1/4" with 3 drawers, central lock and lock-in mechanism.

IMPORTANT Drawer layouts are included with the proposals. See chart to the left for the number of compartments.

NOTE For models without drawer layouts, change the last 2 numbers of the model to the next sequential even number.
Ex. : L3BBD-2401 with L3BBD-2402 without

A security mechanism B on the drawer and/or L3 on the housing is required for all mobile applications.

Number of Compartments (layout code)		
Drawer dimensions	18" x 21"	18" x 27"
3" to 5"	9 (0206)	9 (0206)
6" and 8"	6 (0104)	6 (0104)
12"	4 (0102)	4 (0102)

18" Wide

Each model includes two front handles.

 <p>3 drawers L3BBD-2401__ 18" x 21" x 29 1/4" L3BBG-2401__ 18" x 27" x 29 1/4"</p>	 <p>4 drawers L3BBD-2801__ 18" x 21" x 33 1/4" L3BBG-2801__ 18" x 27" x 33 1/4"</p>	 <p>6 drawers L3BBD-3401__ 18" x 21" x 39 1/4" L3BBG-3401__ 18" x 27" x 39 1/4"</p>	 <p>6 drawers L3BBD-4001__ 18" x 21" x 45 1/4" L3BBG-4001__ 18" x 27" x 45 1/4"</p>
 <p>3 drawers L3BBD-2403__ 18" x 21" x 29 1/4" L3BBG-2403__ 18" x 27" x 29 1/4"</p>	 <p>4 drawers L3BBD-2803__ 18" x 21" x 33 1/4" L3BBG-2803__ 18" x 27" x 33 1/4"</p>	 <p>4 drawers L3BBD-3403__ 18" x 21" x 39 1/4" L3BBG-3403__ 18" x 27" x 39 1/4"</p>	 <p>7 drawers L3BBD-4003__ 18" x 21" x 45 1/4" L3BBG-4003__ 18" x 27" x 45 1/4"</p>



36" Wide

Each model includes one side handle.



9 drawers
 L3BED-2401 __ 36" x 21" x 29 1/4"
 L3BEG-2401 __ 36" x 27" x 29 1/4"



5 drawers / 1 door / 1 shelf
 L3BED-3401 __ 36" x 21" x 39 1/4"
 L3BEG-3401 __ 36" x 27" x 39 1/4"



12 drawers
 L3BED-4001 __ 36" x 21" x 45 1/4"
 L3BEG-4001 __ 36" x 27" x 45 1/4"



11 drawers
 L3BED-2801 __ 36" x 21" x 33 1/4"
 L3BEG-2801 __ 36" x 27" x 33 1/4"



10 drawers
 L3BED-3403 __ 36" x 21" x 39 1/4"
 L3BEG-3403 __ 36" x 27" x 39 1/4"



15 drawers
 L3BED-4003 __ 36" x 21" x 45 1/4"
 L3BEG-4003 __ 36" x 27" x 45 1/4"

54" Wide

Each model includes one side handle.



12 drawers
 L3BJD-2801 __ 54" x 21" x 33 1/4"
 L3BJG-2801 __ 54" x 27" x 33 1/4"



15 drawers
 L3BJD-3401 __ 54" x 21" x 39 1/4"
 L3BJG-3401 __ 54" x 27" x 39 1/4"



18 drawers
 L3BJD-4001 __ 54" x 21" x 45 1/4"
 L3BJG-4001 __ 54" x 27" x 45 1/4"



Security Accessories

Drawer Lock L3



2 keys provided with each lock;
Compatible with all drawer dimensions;
The mechanism (covered by a galvanized box) requires 3" W x 1" D inside the drawer;
Order by adding L3 to drawer or partitioning number.
Ex: LF31-182106L3;

Note : A security panel LF91 must be ordered to block access between two drawers if managing two different users.



Product #	
L3	

Door Lock L3 / LP



2 keys provided with each lock;
To order a lock, complete the door number by L3.
Ex: LB30-1812L3;
To order a safety hasp, complete the door number by LP.
Ex: LB30-1812LP;
Note: A security panel LF91 must be ordered to block access between two doors if managing two different users.

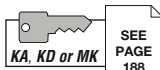

Product #	
L3	Lock
LP	Safety Hasp

Central Locking Mechanism L3 / LP



Allows user to lock all drawers in the cabinet at the same time;
Easy to retrofit;
Possible to change drawer layout without touching locking mechanism;
To order a lock, complete the product housing number or the proposal cabinet number by L3. Ex.: LA30-182134L3;
To order a safety hasp for padlock, complete the housing number with LP. Ex.: LA30-182134LP.

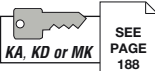

Product #	
L3	Lock
LP	Safety hasp

Lock-In Mechanism B



Activated by sliding the mechanism with thumb;
Drawer closes without having to reactivate the slide mechanism;
Stops drawers from opening on their own;
Easy to retrofit;
Order by adding B to the drawer or partitioning number.
Ex.: LF31-182106B.

Product #	
B	

Drawer and Handle Accessories

Handle Protector LF70



Installs on drawer handle by clipping in place;
Made of transparent plastic;
Protects identification labels from dust, grease and dirt;
Easy to remove;
Note: Labels available; 30 per page - 10 pages. Order LF71-425075.
Product #
LF70-18

Foam for Protection LG41

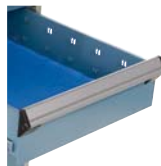

Protects stored objects;
Blue foam 1/4" thick.
Product # For drawer
LG41-1821-01 18" W x 21" D
LG41-1827-01 18" W x 27" D

NOTE Partitions and dividers may not be installed with this foam.

Folder Hanging Bars LG31



For storing hanging folders;
Can be used for both letter and legal sizes;
Designed for 12" drawers.
Product #
LG31-18

PVC Drawer Liner LG40



Protects stored objects;
Non-skid surface;
Can be installed under partitions and dividers;
Thickness: 3/32".
Product # For drawer
LG40-1821-01 18" W x 21" D
LG40-1827-01 18" W x 27" D

Foam for Tools LG42



Oil resistant and non-absorbent;
1 blue foam 1/4" thick;
1 black self-adhesive 1/2" thick foam;
Sold without cut-outs. May be cut using a utility knife.
Product # For drawer
LG42-1821-01 18" W x 21" D
LG42-1827-01 18" W x 27" D



Front to Back Partition LG02

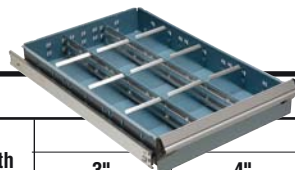

Used to divide the drawer along its depth;
Clip system locks dividers in place;
Galvanized steel;
RG10 dividers can be used in between partitions to make smaller compartments;
Compatible with plastic bins and PVC drawer liners.

Drawer Depth Nominal (real)	Drawer Height					
	3"	4"	5"	6"	8"	12"
21" (18")	1 5/8" high LG02-2103	2 5/8" high LG02-2104	3 5/8" high LG02-2105	4 5/8" high LG02-2106	6 5/8" high LG02-2108	8 5/8" high LG02-2110
27" (24")	LG02-2703	LG02-2704	LG02-2705	LG02-2706	LG02-2708	LG02-2710



Plastic Bin



RG20

Simplify storing, moving and managing small parts. Lightweight and resistant;
 Designed for 3" and 4" high drawers;
 45° angle for easy identification of bin contents and removal of bins;
 Compatible with partitions and dividers;
 6" plastic bins can be subdivided.

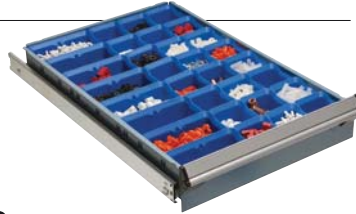

Dimensions			Bin	Product # Partition	Divider
W	D	H			
3"	3"	2"	RG20-030302	-	-
4"	3"	2"	RG20-040302	-	-
6"	3"	2"	RG20-060302	RG22-0302	-
6"	6"	2"	RG20-060602	RG22-0602	RG24-0602
3"	3"	3"	RG20-030303	-	-
4"	3"	3"	RG20-040303	-	-
6"	3"	3"	RG20-060303	RG22-0303	-
6"	6"	3"	RG20-060603	RG22-0603	RG24-0603

Drawer Divider



RG10

Clip in place;
 45° angle for identifying compartment contents;
 Adjustable every 3" (c/c).



Divider Width Nominal	Drawer Height					
	3" 1 5/8" high	4" 2 5/8" high	5" 3 5/8" high	6" 4 5/8" high	8" 6 5/8" high	12" 8 5/8" high
3"	RG10-03003	RG10-03004	RG10-03005	RG10-03006	RG10-03008	RG10-03010
5"	RG10-05003	RG10-05004	RG10-05005	RG10-05006	RG10-05008	RG10-05010
6"	RG10-06003	RG10-06004	RG10-06005	RG10-06006	RG10-06008	RG10-06010
7.5"	RG10-07503	RG10-07504	RG10-07505	RG10-07506	RG10-07508	RG10-07510
9"	RG10-09003	RG10-09004	RG10-09005	RG10-09006	RG10-09008	RG10-09010
10"	RG10-10003	RG10-10004	RG10-10005	RG10-10006	RG10-10008	RG10-10010
12"	RG10-12003	RG10-12004	RG10-12005	RG10-12006	RG10-12008	RG10-12010
15"	RG10-15003	RG10-15004	RG10-15005	RG10-15006	RG10-15008	RG10-15010

Tops

Laminated Wood Top

WS14



Made with varnished hardwood slats;
 90° radius front edge for more comfort;
 Thickness : 1 3/4";
 Attractive appearance.

Product #	W x D	Application
WS14-3621A*	36" x 21"	2 cabinets (21" deep)
WS14-3627A*	36" x 27"	2 cabinets (27" deep)
WS14-5421A*	54" x 21"	3 cabinets (21" deep)
WS14-5427A*	54" x 27"	3 cabinets (27" deep)

NOTE *Please check with your customer service representative for lead time.

Plastic Laminated Top

WS16



Color : white;
 90° radius front edge for more comfort;
 Thickness : 1 1/2";
 Attractive appearance.

Product #	W x D	Application
WS16-3621A*	36" x 21"	2 cabinets (21" deep)
WS16-3627A*	36" x 27"	2 cabinets (27" deep)
WS16-5421A*	54" x 21"	3 cabinets (21" deep)
WS16-5427A*	54" x 27"	3 cabinets (27" deep)

NOTE * Please check with your customer service representative for lead time.

Steel Top with Rubber Mat

RC32



Non-slip rubber surface;
 Sides and back formed with a double fold, 1" high.

Product #	W x D	Application
RC32-3621-01	36" x 21"	2 cabinets (21" deep)
RC32-3627-01	36" x 27"	2 cabinets (27" deep)
RC32-5421-01	54" x 21"	3 cabinets (21" deep)
RC32-5427-01	54" x 27"	3 cabinets (27" deep)

Foldaway Shelf

RC00

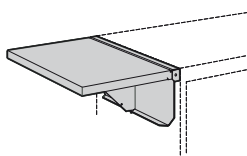

Capacity: 50 lb (evenly distributed load);
 Rubber mat surface for added protection;
 RC01 side stops can be installed as an option.

Product #	W x D
RC00-152101	15" x 21"
RC00-152701	15" x 27"

Side and Back Stops for Foldaway Shelf

RC01

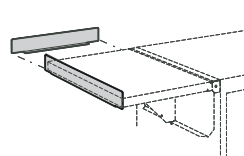

Use 15" side stop for front and back of shelf;
 Use 21" or 27" side stop for the sides;
 Height : 1".

Product #	Width
RC01-15	15"
RC01-21	21"
RC01-27	27"



Housing and Doors

"L" Compact Cabinet Housing

LA30

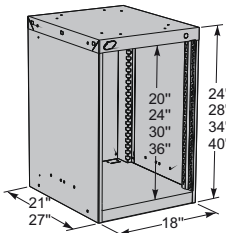

Create a customized work space with a wide range of possibilities;

Four standard heights:

- 24" (20" inside)
- 28" (24" inside)
- 34" (30" inside)
- 40" (36" inside)

Drawers, shelves and doors can be installed in the housing;

Housing is equipped with knock-outs :

- On the top: for stacking a drawer unit housing LD75;
- On the sides: for assembling cabinets side-to-side.

Requires a LB93 cart for a simple mobile cabinet or a LB97 base for casters for double or triple cabinet;

Lock on the housing allows user to secure all drawers at the same time, complete the product number with L3;

To order hasp for padlock, complete the product number with LP.

Product #	W x D x H	Product #	W x D x H
LA30-182124	18" x 21" x 24"	LA30-182724	18" x 27" x 24"
LA30-182128	18" x 21" x 28"	LA30-182728	18" x 27" x 28"
LA30-182134	18" x 21" x 34"	LA30-182734	18" x 27" x 34"
LA30-182140	18" x 21" x 40"	LA30-182740	18" x 27" x 40"

Integrated Door

LB30

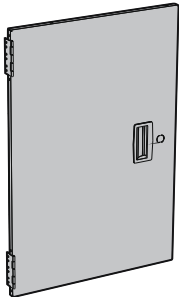

6 standard heights;

Handle fitted in plastic;

Can be installed with hinges on right or left;

Shelf LB24 must be ordered as storage surface for doors installed above a drawer or another door;

For central locking mechanism, complete the product number with L3;

For hasp for padlock, complete the product number with LP.

Product #	W X H	Product #	W X H
LB30-1812	18" X 12"	LB30-1824	18" X 24"
LB30-1818	18" X 18"	LB30-1830	18" X 30"
LB30-1820	18" X 20"	LB30-1836	18" X 36"



"L" Compact Drawer

LF31

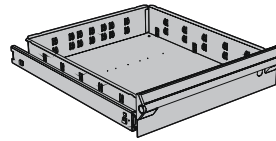

100 lb capacity, 100% extension;

Wide range of accessories available to adapt to your storage needs;

Precision ball bearing drawer slides included;

Easy hook-on assembly;

For drawer layout proposals, see pages 24-25;

Available drawer heights; 3", 4", 5", 6", 8" and 12";

For a 12" drawer: Order LG31 hanging folder bars for letter (8½" x 11") or legal size (8½" x 14") folders;

Order by adding the drawer height to the product number and by specifying the lock-in and the drawer lock. Ex.: LF31-182106 B, LF31-182106 L3, LF31-182106 L3 B.

Product #	W x D
LF31-1821	18" x 21"
LF31-1827	18" x 27"



A security mechanism B on the drawer and/or L3 on the housing is required for all mobile applications.

Adjustable Shelf

LB24

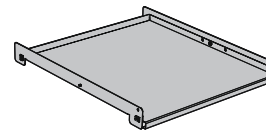

For storing larger, bulkier items;

Equipped with edges along sides and back;

Adjustable in height every 1" c/c;

Capacity up to 100 lb evenly distributed load;

2 versions of the adjustable shelf are possible depending on if the housing is equipped with a central locking mechanism;

Available in galvanized steel;

Order by adding the housing depth - 21" or 27".

Product #	For LA30
LB24-18_01	with L3/LP on the housing
LB24-18_02	without L3/LP on the housing

Security Panel

LF91

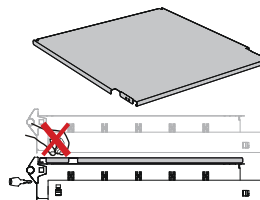

Allows for the cabinet to be divided up for more than one user;

Adjustable at every 1" c/c;

Must be ordered to:

- Block access between drawers
- Block access when a door with lock is installed under a drawer
- Block space when a door is installed above a drawer.

2 versions of the security panel are possible depending on if the housing is equipped with a central locking mechanism;

Available in galvanized steel;

Order by adding the housing depth - 21" or 27".

Product #	For LA30
LF91-18_01	with L3/LP on the housing
LF91-18_02	without L3/LP on the housing

Mobility

4" Casters

LB81



Sold in pairs;
Choice of 3 types of casters: rigid, swivel, swivel with total-lock brake system (on wheel and swivel);
Capacity : 420 lb per caster;
Total height : 5 1/4";
Polyurethane casters (do not mark floors). Superior quality industrial casters;
Requires a LB93 cart or a LB97 base for casters.

Product #	Type of Caster
LB81-01	Rigid
LB81-02	Swivel
LB81-03	Swivel with total-lock brake system

6" Casters

LB84



Sold in pairs;
Choice of 3 types of casters : rigid, swivel, swivel with total-lock brake system (on wheel and swivel);
Capacity : 900 lb per caster;
Total height : 7 1/2";
Polyurethane casters (do not mark floors). Superior quality industrial casters;
Requires a LB93 cart or a LB97 base for casters.

Product #	Type of Caster
LB84-01	Rigid
LB84-02	Swivel
LB84-03	Swivel with total-lock brake system



6" Mag Casters

LB85



Sold in pairs
Choice of 3 types of casters: rigid, swivel, swivel with total-lock brake system (on wheel and swivel);
Aluminium wheel with durable chrome plating;
Capacity: 1000 lb per caster;
Total height: 7 1/2";
Polyurethane casters (do not mark floors). Superior quality industrial casters;
Requires a LB93 cart or a LB97 base for casters.

Product #	Type of Caster
LB85-01	Rigid
LB85-02	Swivel
LB85-03	Swivel with total-lock brake system

Cart for Single Cabinet

LB93

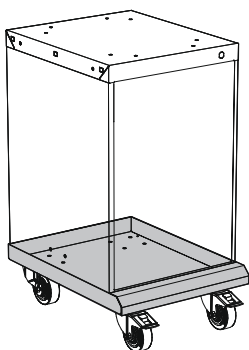

Used when installing casters on a single cabinet;
Installed under 24", 28", 34" or 40" high cabinets without base;
Compatible with 4" and 6" casters (sold separately);
Attention: Mobile cabinets must have load evenly distributed to avoid tipping when opening a drawer.

Product #	W x D
LB93-1821	18" x 21"
LB93-1827	18" x 27"

Base for Casters

LB97

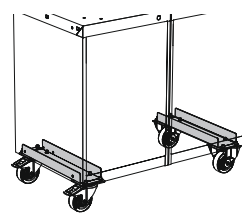

Compatible with 4" and 6" casters (sold separately);
Used to install casters under double or triple cabinets;
Installed under 24", 28", 34" or 40" high cabinets without base;
Note: Sold individually, order 2 bases for a double cabinet and three bases for a triple cabinet;
Attention: Mobile cabinets must have load evenly distributed to avoid tipping when opening a drawer.

Product #	Depth
LB97-21	21"
LB97-27	27"

Side Handle

RB90

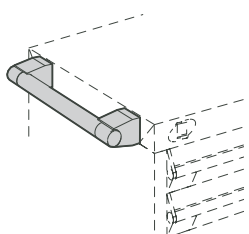

Attaches to the side of double or triple cabinets : specify which side (left or right);
Anodized aluminum with durable plastic end caps;
Large handle to make moving cabinet easier.

Product #	Handle Depth	For Cabinet
RB90-21	18"	21" D
RB90-27	24"	27" D

Front Handles

RB92

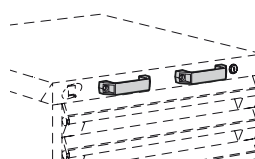

Sold in pairs;
Attach to the front of single 18" wide cabinets;
Durable plastic.

Product #
RB92-01

"R" Multi-Drawer Cabinet

"R" MULTI-DRAWER



"R" MULTI-DRAWER

For personalized space management, our multi-drawer cabinet will surprise you, not only with its attractive look but also with its amazing versatility. Whether you're placing an order for one cabinet, or for one thousand, our customer service representatives will gladly help you build just the cabinet your customer is looking for.

Four sizes of cabinets are available : 48" x 24", 48" x 27", 60" x 24" and 60" x 27". With the 48" wide cabinet you can create 2 banks of 24" wide and one bank of 48" wide drawers. With the 60" wide you can build a cabinet with 2 banks of 30" wide with a top bank of 60" wide. Or, one bank of 24" wide and another of 36" wide with a 60" wide on the top. Couple these choices with our 10 available drawer heights (3" to 14"), our 14 standard colors and our cabinet and drawer accessories and you can create a truly personalized cabinet.

This cabinet is available in either a mobile or a stationary version. The mobile cabinet has high quality casters, stabilizing bars to ensure the rigidity of the housing, a sturdy handle that guarantees a firm grip, as well as an integrated locking mechanism, which makes this cabinet ideal for mobile applications. Both models include a lock that allows all drawers to be locked with the turn of one key.

The multi-drawer cabinet is a versatile cabinet, available in a variety of colors.

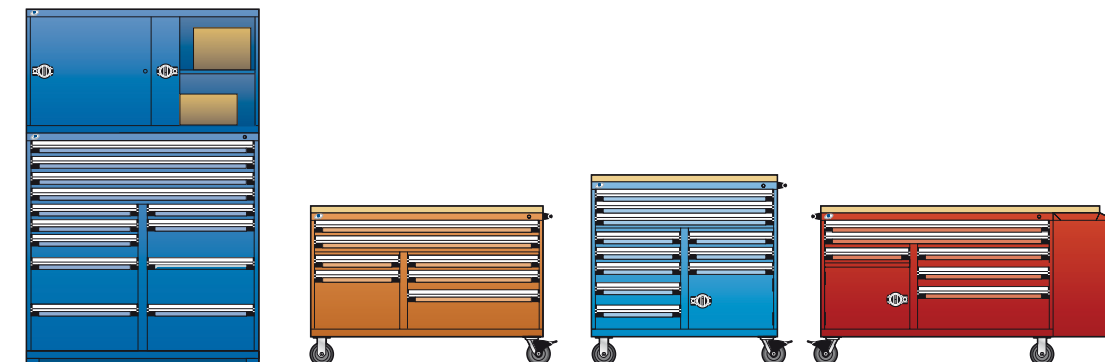

Proposals - "R" Mobile Cabinet

Here are some of the possible mobile multi-drawer cabinet configurations. For a more personalized configuration, contact your customer service representative.

The mobile cabinet models have 6" casters, including 2 rigid and 2 swivel with total-lock brake system (polyurethane casters do not mark floors, high-quality industrial grade);

All cabinets include a standard cabinet lock (L3) as well as the integrated lock-in mechanism (A) on each drawer;

The mobile cabinets include stabilizing bars to ensure the rigidity of the housing;

For a safety hasp (LP), contact your customer service representative;

To add a stainless steel, galvanized steel, painted steel, steel with rubber mat or wood top;

Each model includes a handle on the side, which provides the user with a good grip for manoeuvring the cabinet.

SEE PAGE 36

SEE PAGE 38

IMPORTANT

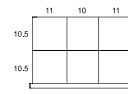

Drawer partitions are included in models.



SEE PAGE 188

NOTE

For drawers without partitioning, complete the even number following the last two digits of the model.

Ex. : R5GHE-3003 with R5GHE-3004 without

Number of Compartments (layout code)

Drawer dimensions	24" x 24"	24" x 27"	30" x 24"	30" x 27"	36" x 24"	36" x 27"	48" x 24"	48" x 27"	60" x 24"	60" x 27"
3" to 5" high	12 (0308)	20 (0316)	30 (0524)	25 (0420)	30 (0524)	30 (0425)	40 (0732)	32 (0724)	70 (1356)	84 (1370)
6" to 8" high	9 (0206)	12 (0209)	12 (0308)	12 (0308)	12 (0308)	12 (0308)	15 (0410)	15 (0410)	24 (0716)	21 (0614)
9" and higher	6 (0104)	6 (0104)	9 (0206)	9 (0206)	9 (0206)	6 (0203)	8 (0304)	8 (0304)	12 (0308)	12 (0308)

NOTE For inside drawer dimensions.

SEE PAGES 134-135

48" Wide



12 drawers
R5GHE-3003 48" x 24" x 37 1/2"
R5GHG-3003 48" x 27" x 37 1/2"



10 drawers
R5GHE-3005 48" x 24" x 37 1/2"
R5GHG-3005 48" x 27" x 37 1/2"



10 drawers
R5GHE-3007 48" x 24" x 37 1/2"
R5GHG-3007 48" x 27" x 37 1/2"



9 drawers
R5GHE-3009 48" x 24" x 37 1/2"
R5GHG-3009 48" x 27" x 37 1/2"



9 drawers
R5GHE-3401 48" x 24" x 41 1/2"
R5GHG-3401 48" x 27" x 41 1/2"



10 drawers
R5GHE-3403 48" x 24" x 41 1/2"
R5GHG-3403 48" x 27" x 41 1/2"



11 drawers
R5GHE-3405 48" x 24" x 41 1/2"
R5GHG-3405 48" x 27" x 41 1/2"



12 drawers
R5GHE-3809 48" x 24" x 45 1/2"
R5GHG-3809 48" x 27" x 45 1/2"



13 drawers
R5GHE-3811 48" x 24" x 45 1/2"
R5GHG-3811 48" x 27" x 45 1/2"



10 drawers
R5GHE-3813 48" x 24" x 45 1/2"
R5GHG-3813 48" x 27" x 45 1/2"



11 drawers
R5GHE-3815 48" x 24" x 45 1/2"
R5GHG-3815 48" x 27" x 45 1/2"



12 drawers
R5GHE-3817 48" x 24" x 45 1/2"
R5GHG-3817 48" x 27" x 45 1/2"

Proposals - "R" Mobile Cabinet

60" Wide

"R" MULTI-DRAWER



10 drawers	
R5GKE-3005	60" x 24" x 37 1/2"
R5GKG-3005	60" x 27" x 37 1/2"



10 drawers	
R5GKE-3007	60" x 24" x 37 1/2"
R5GKG-3007	60" x 27" x 37 1/2"



9 drawers	
R5GKE-3009	60" x 24" x 37 1/2"
R5GKG-3009	60" x 27" x 37 1/2"



10 drawers	
R5GKE-3403	60" x 24" x 41 1/2"
R5GKG-3403	60" x 27" x 41 1/2"



11 drawers	
R5GKE-3405	60" x 24" x 41 1/2"
R5GKG-3405	60" x 27" x 41 1/2"



12 drawers	
R5GKE-3809	60" x 24" x 45 1/2"
R5GKG-3809	60" x 27" x 45 1/2"



13 drawers	
R5GKE-3811	60" x 24" x 45 1/2"
R5GKG-3811	60" x 27" x 45 1/2"



10 drawers	
R5GKE-3813	60" x 24" x 45 1/2"
R5GKG-3813	60" x 27" x 45 1/2"



11 drawers	
R5GKE-3815	60" x 24" x 45 1/2"
R5GKG-3815	60" x 27" x 45 1/2"

NOTE The 24" bank of drawers is always installed on the left in the 60" wide housing.



Polyurethane casters



Stabilizing bars



Side cabinet



Integrated lock-in mechanism



Proposals - "R" Stationary Cabinet

Here are some of the possible stationary multi-drawer cabinet configurations. For a more personalized configuration, contact your customer service representative.

The stationary cabinet models include a 2" forklift base (cover plate included);

To add a stainless steel, galvanized steel, painted steel, steel with rubber mat or wood top;

All cabinets include a standard cabinet lock (L3);

For a safety hasp (LP), contact your customer service representative.

SEE PAGE 38

SEE PAGE 10



SEE PAGE 188

IMPORTANT

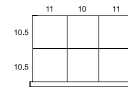

Drawer partitions are included in models.

NOTE

For drawers without partitioning, complete the even number following the last two digits of the model.

Ex. : R5EHE-3005 with R5EHE-3006 without

Number of Compartments (layout code)

Drawer dimensions	24" x 24"	24" x 27"	30" x 24"	30" x 27"	36" x 24"	36" x 27"	48" x 24"	48" x 27"	60" x 24"	60" x 27"
3" to 5" high	12 (0308)	20 (0316)	30 (0524)	25 (0420)	30 (0524)	30 (0425)	40 (0732)	32 (0724)	70 (1356)	84 (1370)
6" to 8" high	9 (0206)	12 (0209)	12 (0308)	12 (0308)	12 (0308)	12 (0308)	15 (0410)	15 (0410)	24 (0716)	21 (0614)
9" and higher	6 (0104)	6 (0104)	9 (0206)	9 (0206)	9 (0206)	6 (0203)	8 (0304)	8 (0304)	12 (0308)	12 (0308)

NOTE For inside drawer dimensions.

SEE PAGES 134-135

48" Wide



10 drawers
R5EHE-3005 48" x 24" x 32"
R5EHG-3005 48" x 27" x 32"



10 drawers
R5EHE-3403 48" x 24" x 36"
R5EHG-3403 48" x 27" x 36"



11 drawers
R5EHE-3405 48" x 24" x 36"
R5EHG-3405 48" x 27" x 36"



12 drawers
R5EHE-3809 48" x 24" x 40"
R5EHG-3809 48" x 27" x 40"



17 drawers
R5EHE-5801 48" x 24" x 60"
R5EHG-5801 48" x 27" x 60"



20 drawers
R5EHE-5803 48" x 24" x 60"
R5EHG-5803 48" x 27" x 60"



13 drawers
R5EHE-3811 48" x 24" x 40"
R5EHG-3811 48" x 27" x 40"



12 drawers
R5EHE-3817 48" x 24" x 40"
R5EHG-3817 48" x 27" x 40"



R5EHG-3007



R5EHG-4403



R5EHE-5807

"R" MULTI-DRAWER

Proposals - "R" Stationary Cabinet

60" Wide

MULTI-DRAWER "R"



10 drawers

R5EKE-3403 60" x 24" x 36"

R5EKG-3403 60" x 27" x 36"



11 drawers

R5EKE-3405 60" x 24" x 36"

R5EKG-3405 60" x 27" x 36"



12 drawers

R5EKE-3809 60" x 24" x 40"

R5EKG-3809 60" x 27" x 40"



10 drawers

R5EKE-3813 60" x 24" x 40"

R5EKG-3813 60" x 27" x 40"



18 drawers

R5EKE-5813 60" x 24" x 60"

R5EKG-5813 60" x 27" x 60"



20 drawers

R5EKE-5817 60" x 24" x 60"

R5EKG-5817 60" x 27" x 60"



R5EKG-3001



R5EKE-4403



R5EKE-5801

Hanging Side Cabinet - Side Access

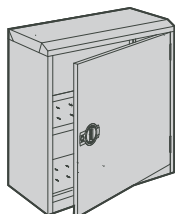

Includes one bottom shelf;
 Shelves adjustable every inch c/c;
 SH52 dividers can be installed on shelves;
 Equipped with holes on the top to allow installation between one common work surface to a multi-drawer cabinet;
 Opens 180° for full access to items stored inside;
 Door comes with standard lock;
 Capacity : 600 lb;
 Choices of doors. Complete the product number from the chart with the following :

- 01 : Solid door
- 02 : Glass door

Height	Width x Depth		Number of (RD05) Adjustable Shelves
	24" x 14"	27" x 14"	
24"	R5QCA-24	R5QPA-24	-
28"	R5QCA-28	R5QPA-28	1
30"	R5QCA-30	R5QPA-30	1
34"	R5QCA-34	R5QPA-34	1
38"	R5QCA-38	R5QPA-38	2
For cabinet	24" D	27" D	

NOTE

For compatibility with a work surface, choose the part number of a work surface 12" wider than your cabinet. Ex.: RC__-6Q24 for a mobile cabinet 48" W x 24" D.



R5GHE-3807

Hanging Side Cabinet - Front Access

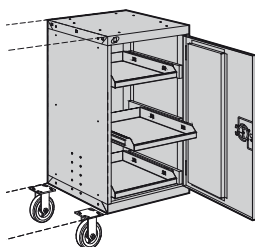
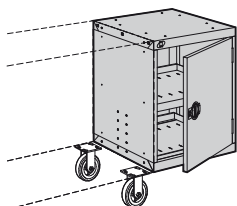

The shelves are adjustable every inch c/c;
 SH52 dividers can be installed on both bottom and adjustable shelves;
 Equipped with holes on the top to allow installation between one common work surface to a multi-drawer cabinet;
 The roll-out shelf has a capacity of 175 lb, 75% extension;
 Door opens 180° allowing clearance space for easy handling of objects in the cabinet;
 Door comes with standard lock;
 Capacity : 500 lb;
 Choice of configurations. Complete the number :
 Bottom shelf and adjustable shelf(ves)

- 03 : Solid door
- 05 : Glass door

Roll-out shelves

- 04 : Solid door
- 06 : Glass door



R5XSE-3001

NOTE

For compatibility with a work surface, choose the part number of a work surface 24" wider than your cabinet. Ex.: RC__-8424 for a mobile cabinet 60" W x 24" D.

Height	Width x Depth 24" x 24"	Number of (RB22)	Number of (RF50)
		Adjustable Shelves	Roll-Out Shelves
28"	R5QCE-28	1	2
30"	R5QCE-30	1	2
34"	R5QCE-34	1	2
38"	R5QCE-38	2	3
For cabinet	24" D		

Foldaway Shelf

RC00

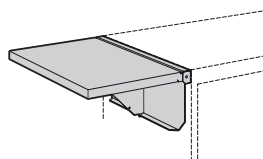

Capacity : 50 lb, evenly distributed load;
 Rubber mat surface for added protection;
 RC01 side stops can be installed as an option.

Product #	W x D
RC00-152401	15" x 24"
RC00-152701	15" x 27"

Side and Back Stops for Foldaway Shelf

RC01

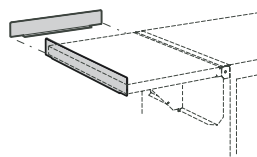

Use 15" stop for front and back of shelf;
 Use 24" or 27" stop for the sides;
 Height : 1".

Product #	Width
RC01-15	15"
RC01-24	24"
RC01-27	27"

Spider® Shelving System

SPIDER® SHELVING SYSTEM



SPIDER®
SHELVING SYSTEM

THE MOST VERSATILE SHELVING SYSTEM THAT EXISTS

Much more than a simple shelving unit!

Sturdy construction and quick assembly, the Spider® shelving system meets all of your storage needs. With its vast range of accessories, it offers the most diverse options on the market, making finding solutions for all your storage problems as easy as 1, 2, 3.

- The combination of shelving and Mini-Racking opens up a whole new avenue of possibilities;
- Adding modular drawers guarantees you secure organization of all your small parts;
- Vertical expansion is also a possibility thanks to our multi-level shelving system.

Designed for intensive use, our modular storage system will maximize the space in your warehouse, parts department, maintenance workshop, distribution center, etc.

Our expertise ensures you peace of mind for all of your needs, present and future!



R5XEC-2004

Spider® Shelving System

The Rousseau Advantages



Assembly is simple: shelves are installed on the posts using 4 compression clips, in 14 gauge steel. This makes for easy and fast adjustments.

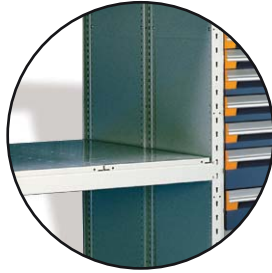

Mini-Racking integrated into your shelving optimizes your storage possibilities.

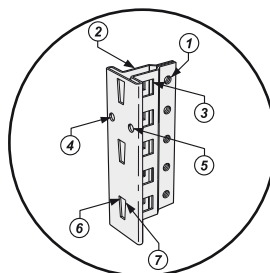

A unique and super functional post. The common post is the cornerstone of the structure. Its unique T-shape offers up to 7 fixing zones for different applications. Plus, its hollow center makes for installations without interference.

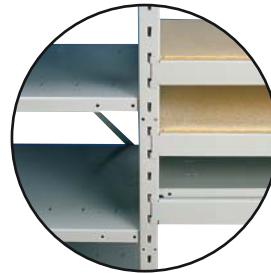

The steel beams are designed for several types of decking: wood, steel and wire. Two types of beams are available, depending on the load capacity and dimensions required. Load capacity can reach 1925 lb.



Each component is designed to offer you an easy-to-use product.

NOTE

The unique shape of the Spider® post is a Rousseau Metal Inc. trademark.

General Dimensions

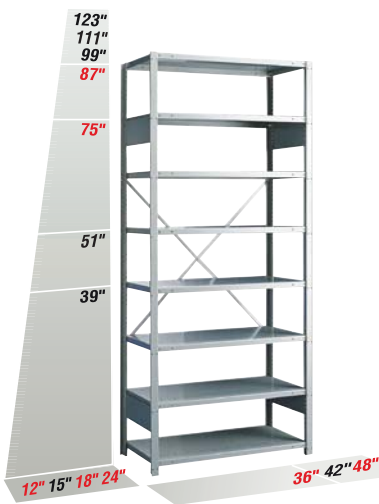

SHE1024

Popular dimensions shown in red.



SRE5127S

Index	Page(s)
Spider® Shelving System	56 - 57
Industrial Shelving	
Proposals	58 - 62
Accessories	63 - 68
Components	69 - 71
Mini-Racking	
Proposals	72 - 73
Accessories	74
Components	75 - 77



R5SSE-874804



R5SSE-874806



SRE9001

Industrial Shelving Proposals

SHELVING



SHE1024



SHE2024

When ordering, model numbers must be completed as follows:



H for posts with smooth finish surface
R for posts with perforated surface

	Starter Unit	Add-on Unit
BOLTED uprights	D	A
WELDED uprights	E	B

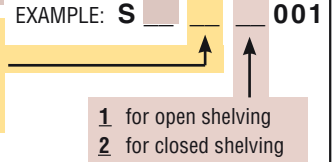

Example : S H D 1 0 0 1

For a model with smooth finish posts and bolted open uprights

Open and Closed Shelving : 36", 42" and 48" Wide

Open Shelving

Shown here are several of the more popular shelving models.

Proposals include open or closed uprights and BOX shelves;

Closed shelving proposals include back panels and front base;

Open shelving proposals include one back brace.

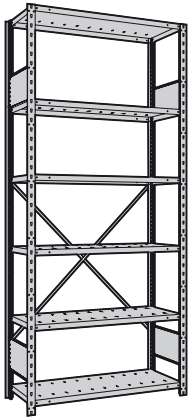

SRE1011
Starter

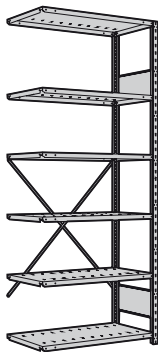

SRB1011
Add-on

Closed Shelving

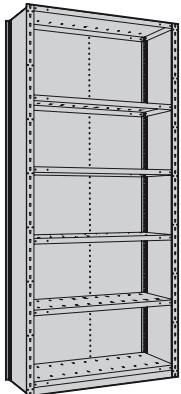

SRE2011
Starter

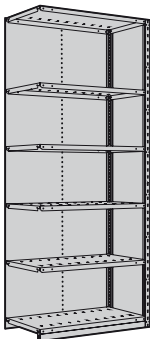

SRB2011
Add-on

W	Dimensions		Number of Shelves				
	D	H	5	6	7	8	
36"	12"	75"	S_001	S_007	S_013	S_019	
			S_002	S_008	S_014	S_020	
			S_003	S_009	S_015	S_021	
	12"	87"	S_004	S_010	S_016	S_022	
			S_005	S_011	S_017	S_023	
			S_006	S_012	S_018	S_024	
	12"	99"	S_401	S_407	S_413	S_419	
			S_402	S_408	S_414	S_420	
			S_403	S_409	S_415	S_421	
	42"	12"	75"	S_131	S_137	S_143	S_149
				S_132	S_138	S_144	S_150
				S_133	S_139	S_145	S_151
12"		87"	S_134	S_140	S_146	S_152	
			S_135	S_141	S_147	S_153	
			S_136	S_142	S_148	S_154	
12"		99"	S_531	S_537	S_543	S_549	
			S_532	S_538	S_544	S_550	
			S_533	S_539	S_545	S_551	
48"		12"	75"	S_031	S_037	S_043	S_049
				S_032	S_038	S_044	S_050
				S_033	S_039	S_045	S_051
	12"	87"	S_034	S_040	S_046	S_052	
			S_035	S_041	S_047	S_053	
			S_036	S_042	S_048	S_054	
	12"	99"	S_431	S_437	S_443	S_449	
			S_432	S_438	S_444	S_450	
			S_433	S_439	S_445	S_451	

Industrial Shelving Proposals

Back-to-Back Open and Closed Shelving : 36", 42" and 48" Wide

Open Shelving

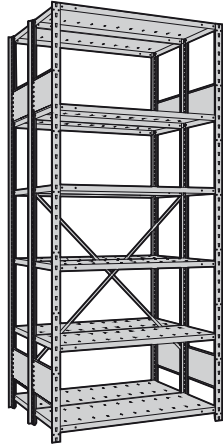

SRE1011B
Starter

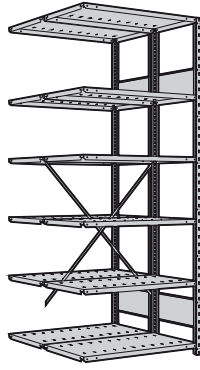

SRB1011B
Add-on

Closed Shelving

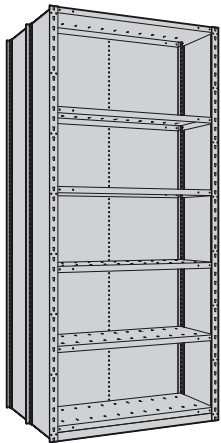

SRE2011B
Starter

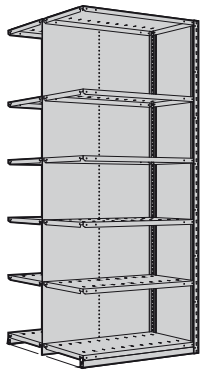

SRB2011B
Add-on

Shown here are several of the more popular shelving models.

Proposals include open or closed uprights and BOX shelves;

Closed shelving proposals include back panels and front base;

Open shelving proposals include one back brace.

Dimensions			Number of Shelves				
W	D	H	10	12	14	16	
36"	24"	75"	S__001B	S__007B	S__013B	S__019B	
			S__002B	S__008B	S__014B	S__020B	
			S__003B	S__009B	S__015B	S__021B	
	24"	87"	S__004B	S__010B	S__016B	S__022B	
			S__005B	S__011B	S__017B	S__023B	
			S__006B	S__012B	S__018B	S__024B	
	24"	99"	S__401B	S__407B	S__413B	S__419B	
			S__402B	S__408B	S__414B	S__420B	
			S__403B	S__409B	S__415B	S__421B	
	42"	24"	75"	S__131B	S__137B	S__143B	S__149B
				S__132B	S__138B	S__144B	S__150B
				S__133B	S__139B	S__145B	S__151B
24"		87"	S__134B	S__140B	S__146B	S__152B	
			S__135B	S__141B	S__147B	S__153B	
			S__136B	S__142B	S__148B	S__154B	
24"		99"	S__531B	S__537B	S__543B	S__549B	
			S__532B	S__538B	S__544B	S__550B	
			S__533B	S__539B	S__545B	S__551B	
48"		24"	75"	S__031B	S__037B	S__043B	S__049B
				S__032B	S__038B	S__044B	S__050B
				S__033B	S__039B	S__045B	S__051B
	24"	87"	S__034B	S__040B	S__046B	S__052B	
			S__035B	S__041B	S__047B	S__053B	
			S__036B	S__042B	S__048B	S__054B	
	24"	99"	S__431B	S__437B	S__443B	S__449B	
			S__432B	S__438B	S__444B	S__450B	
			S__433B	S__439B	S__445B	S__451B	



Industrial Shelving Proposals

87" High Closed Shelving with Accessories

Shown here are several of the most popular shelving models. **NOTE** To complete product #.

SEE
PAGE
58

SHELVING

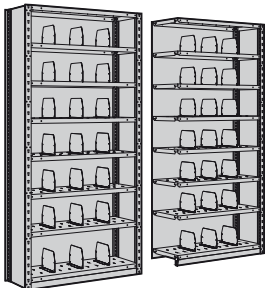

Shelving with Dividers
8 shelves
28 openings :
- 28 op. 12" x 9"
21 dividers, 5 1/2" high

SRE3009 Starter SRB3009 Add-on

Product #	W x D
S_3008	36" x 12"
S_3009	36" x 18"
S_3010	36" x 24"

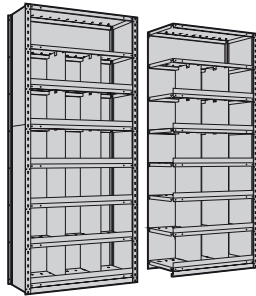

Shelving with Dividers
8 shelves
19 openings :
- 18 op. 12" x 12"
- 1 op. 36" x 12"
12 dividers, 12" high
6 shelf fronts

SRE3022 Starter SRB3022 Add-on

Product #	W x D
S_3021	36" x 12"
S_3022	36" x 18"
S_3023	36" x 24"

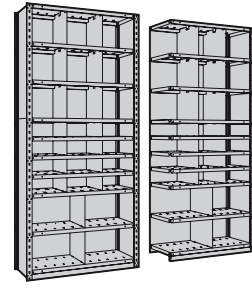

Shelving with Dividers
10 shelves
25 openings :
- 9 op. 12" x 12"
- 12 op. 12" x 6"
- 4 op. 18" x 12"
8 dividers, 6" high
8 dividers, 12" high

SRE3032 Starter SRB3032 Add-on

Product #	W x D
S_3031	36" x 12"
S_3032	36" x 18"
S_3033	36" x 24"

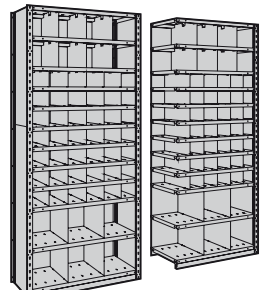

Shelving with Dividers
12 shelves
56 openings :
- 8 op. 9" x 9"
- 42 op. 6" x 6"
- 6 op. 12" x 12"
35 dividers, 6" high
6 dividers, 9" high
4 dividers, 12" high

SRE3052 Starter SRB3052 Add-on

Product #	W x D
S_3051	36" x 12"
S_3052	36" x 18"
S_3053	36" x 24"

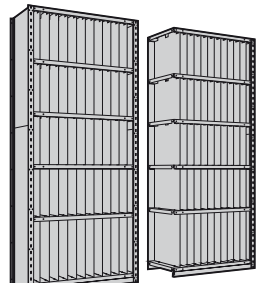

Shelving with Dividers for X-ray Files
6 shelves
60 openings :
- 48 op. 3" x 16"
- 12 op. 3" x 20"
44 dividers, 16" high
11 dividers, 20" high

SRE3062 Starter SRB3062 Add-on

Product #	W x D
S_3062	36" x 18"

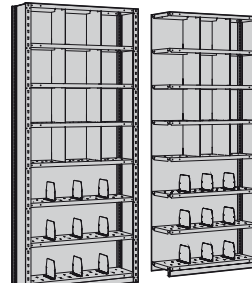

Shelving with Dividers
8 shelves
8 dividers, 12" high
9 dividers, 5 1/2" high

SRE3005 Starter SRB3005 Add-on

Product #	W x D
S_3004	36" x 12"
S_3005	36" x 18"
S_3006	36" x 24"

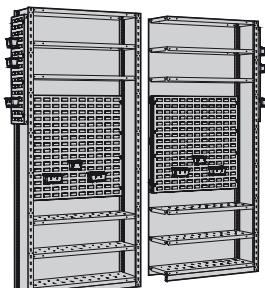

Shelving with Accessories
6 shelves
2 louvered panels
6 plastic bins

SRE3202 Starter SRB3202 Add-on

Product #	W x D
S_3201	36" x 12"
S_3202	36" x 18"
S_3203	36" x 24"

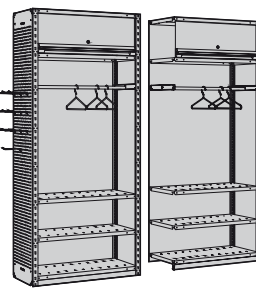

Shelving with Accessories
5 shelves
1 flipper door
1 clothes hanging rail
1 perforated panel
10 hooks

SRE3209 Starter SRB3209 Add-on

Product #	W x D
S_3209	36" x 18"
S_3210	36" x 24"

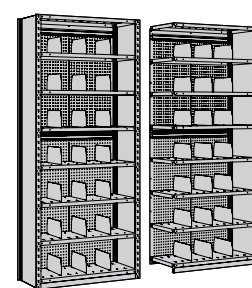

Shelving with Accessories
8 shelves
21 dividers, 5 1/2" high
perforated back panel
10 hooks

SRE3212 Starter SRB3212 Add-on

Product #	W x D
S_3211	36" x 12"
S_3212	36" x 18"
S_3213	36" x 24"

Industrial Shelving Proposals

Shown here are some of the most popular drawers in shelving models.
All models include welded closed upright and hook-on mounting brackets for Spider® shelving, allowing for quick and easy assembly;

Additional accessories available : panels (perforated, louvered and finishing panels), shelf dividers, doors, etc.;

To order an add-on unit, complete product number with A.

SEE PAGES 63-68

IMPORTANT

Drawer partitions are included in models.

NOTE

Drawer partitions are included in models.
For drawers without partitioning, complete the even number following the last two digits of the model.
Ex. : R5SEC-751801 with R5SEC-751802 without

Shelving with drawers must be anchored to the floor (anchoring kit included).



R5XEE-2001

Number of Compartments (layout code)						
Drawer dimensions	36" x 18"	36" x 24"	42" x 18"	42" x 24"	48" x 18"	48" x 24"
3" to 5"	24 (0518)	30 (0524)	20 (0512)	30 (0524)	32 (0724)	40 (0732)
6" to 8"	8 (0304)	12 (0308)	12 (0308)	12 (0308)	10 (0405)	15 (0410)
9" and higher	6 (0203)	9 (0206)	6 (0203)	8 (0304)	8 (0304)	8 (0304)

NOTE For inside drawer dimensions. SEE PAGES 134-135

SHELVING

Shelving with 18", 24", 36" & 48" of Modular Drawers

Shelving with 18" of Modular Drawers



R5SEE-871801

4 drawers :
- 3-4" drawers
- 1-6" drawer

75" H (5 shelves) or 87" H (6 shelves) shelving

W x D	75" H	87" H
36" x 18"	R5SEC-751801_	R5SEC-871801_
36" x 24"	R5SEE-751801_	R5SEE-871801_
42" x 18"	R5SGC-751801_	R5SGC-871801_
42" x 24"	R5SGE-751801_	R5SGE-871801_
48" x 18"	R5SHC-751801_	R5SHC-871801_
48" x 24"	R5SHE-751801_	R5SHE-871801_

Shelving with 24" of Modular Drawers



R5SEE-872401

5 drawers :
- 3-4" drawers
- 2-6" drawers

75" H (5 shelves) or 87" H (6 shelves) shelving

W x D	75" H	87" H
36" x 18"	R5SEC-752401_	R5SEC-872401_
36" x 24"	R5SEE-752401_	R5SEE-872401_
42" x 18"	R5SGC-752401_	R5SGC-872401_
42" x 24"	R5SGE-752401_	R5SGE-872401_
48" x 18"	R5SHC-752401_	R5SHC-872401_
48" x 24"	R5SHE-752401_	R5SHE-872401_

Shelving with 36" of Modular Drawers



R5SEE-873601

7 drawers :
- 3-4" drawers
- 4-6" drawers

75" H (5 shelves) or 87" H (6 shelves) shelving

W x D	75" H	87" H
36" x 18"	R5SEC-753601_	R5SEC-873601_
36" x 24"	R5SEE-753601_	R5SEE-873601_
42" x 18"	R5SGC-753601_	R5SGC-873601_
42" x 24"	R5SGE-753601_	R5SGE-873601_
48" x 18"	R5SHC-753601_	R5SHC-873601_
48" x 24"	R5SHE-753601_	R5SHE-873601_



R5SEE-873603

7 drawers :
- 4-4" drawers
- 2-6" drawers
- 1-8" drawer

75" H (5 shelves) or 87" H (6 shelves) shelving

W x D	75" H	87" H
36" x 18"	R5SEC-753603_	R5SEC-873603_
36" x 24"	R5SEE-753603_	R5SEE-873603_
42" x 18"	R5SGC-753603_	R5SGC-873603_
42" x 24"	R5SGE-753603_	R5SGE-873603_
48" x 18"	R5SHC-753603_	R5SHC-873603_
48" x 24"	R5SHE-753603_	R5SHE-873603_

Industrial Shelving Proposals

SHELVING

Shelving with 48" of Modular Drawers



R5SEE-874801

8 drawers :
 - 8-6" drawers
 75" H (4 shelves) or 87" H (5 shelves) shelving

W x D	75" H	87" H
36" x 18"	R5SEC-754801_	R5SEC-874801_
36" x 24"	R5SEE-754801_	R5SEE-874801_
42" x 18"	R5SGC-754801_	R5SGC-874801_
42" x 24"	R5SGE-754801_	R5SGE-874801_
48" x 18"	R5SHC-754801_	R5SHC-874801_
48" x 24"	R5SHE-754801_	R5SHE-874801_



R5SEE-874803

9 drawers :
 - 4-4" drawers
 - 4-6" drawers
 - 1-8" drawer
 75" H (4 shelves) or 87" H (5 shelves) shelving

W x D	75" H	87" H
36" x 18"	R5SEC-754803_	R5SEC-874803_
36" x 24"	R5SEE-754803_	R5SEE-874803_
42" x 18"	R5SGC-754803_	R5SGC-874803_
42" x 24"	R5SGE-754803_	R5SGE-874803_
48" x 18"	R5SHC-754803_	R5SHC-874803_
48" x 24"	R5SHE-754803_	R5SHE-874803_



R5SEE-874805

10 drawers :
 - 6-4" drawers
 - 4-6" drawers
 75" H (4 shelves) or 87" H (5 shelves) shelving

W x D	75" H	87" H
36" x 18"	R5SEC-754805_	R5SEC-874805_
36" x 24"	R5SEE-754805_	R5SEE-874805_
42" x 18"	R5SGC-754805_	R5SGC-874805_
42" x 24"	R5SGE-754805_	R5SGE-874805_
48" x 18"	R5SHC-754805_	R5SHC-874805_
48" x 24"	R5SHE-754805_	R5SHE-874805_



R5SEE-874807

11 drawers :
 - 4-3" drawers
 - 3-4" drawers
 - 4-6" drawers
 75" H (4 shelves) or 87" H (5 shelves) shelving

W x D	75" H	87" H
36" x 18"	R5SEC-754807_	R5SEC-874807_
36" x 24"	R5SEE-754807_	R5SEE-874807_
42" x 18"	R5SGC-754807_	R5SGC-874807_
42" x 24"	R5SGE-754807_	R5SGE-874807_
48" x 18"	R5SHC-754807_	R5SHC-874807_
48" x 24"	R5SHE-754807_	R5SHE-874807_



R5SEE-874809

7 drawers :
 - 2-3" drawers
 - 3-4" drawers
 - 2-6" drawers
 1 front access roll-out shelf
 75" H (4 shelves) or 87" H (5 shelves) shelving

W x D	75" H	87" H
36" x 18"	R5SEC-754809_	R5SEC-874809_
36" x 24"	R5SEE-754809_	R5SEE-874809_
42" x 18"	R5SGC-754809_	R5SGC-874809_
42" x 24"	R5SGE-754809_	R5SGE-874809_
48" x 18"	R5SHC-754809_	R5SHC-874809_
48" x 24"	R5SHE-754809_	R5SHE-874809_

Industrial Shelving Accessories

Dividers

Shelf Divider

SH50

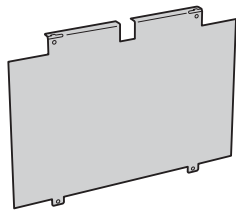

Dividers are attached one into the other;
2 nylon clips provided with each divider;
Nominal dimensions (c/c with shelves);
Offered in painted steel.



Product #	D x H
SH50-1206	12" x 6"
SH50-1209	12" x 9"
SH50-1212	12" x 12"
SH50-1215	12" x 15"
SH50-1218	12" x 18"
SH50-1506	15" x 6"
SH50-1512	15" x 12"
SH50-1806	18" x 6"
SH50-1809	18" x 9"
SH50-1812	18" x 12"
SH50-1815	18" x 15"
SH50-1818	18" x 18"
SH50-1824	18" x 24"

Product #	D x H
SH50-2406	24" x 6"
SH50-2409	24" x 9"
SH50-2412	24" x 12"
SH50-2415	24" x 15"
SH50-2418	24" x 18"
SH50-2424	24" x 24"

Dividers for X-ray Storage

SH50-1816	18" x 16"
SH50-1820	18" x 20"

Other sizes available. Contact your customer service representative for further information.



SHE3062



Partial Divider

PATENTED

SH52

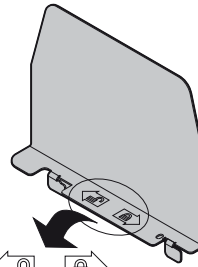

Pictograms make installation easy



Innovative patented divider, facilitates easy position changes;

Height : 5 1/2";

Easy installation, without tools.

Product #	Divider Depth	For Shelves
SH52-1206	7 1/8"	12" D
SH52-1506	10 1/8"	15" D
SH52-1806	13 1/8"	18" D
SH52-2406	19 1/8"	24" D

Dividing Rods

SH56



Sold in pairs;

Steel rod with 1/4" diameter;

90° fold at one end to ensure it stays in place;

Superior rigidity to plastic rods currently used on the market for this type of application.

Product #	Height
SH56-72	72"
SH56-84	84"
SH56-96	96"



SRP0410

Label Holders

Magnetic Label Holder

SH82



Magnetic plastic;
Comes in 6" lengths and can be cut with scissors or a knife;
Note : Paper strips are not included with label holder.

Product #	W x H
SH82-600	6" x 1"

Self-Adhesive Label Holder

SH81



Attaches to surface with self-adhesive strip;

To be used with paper;

Full width;

Note : Paper strips are not included with label holder.

Product #	W x H
SH81-36	36" x 1"
SH81-42	42" x 1"
SH81-48	48" x 1"

Industrial Shelving Accessories

Panels and Doors

SHELVING

Finishing Panel

SH37

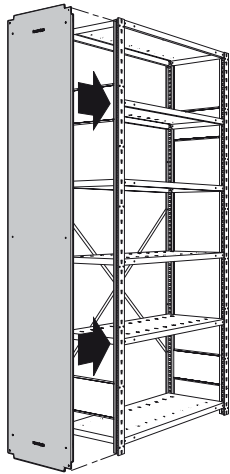

Finishing panel for end of aisle unit;
Fast and easy hook-on assembly;
Polished look;
Compatible with some multi-level shelving applications. Contact our customer service.

Product #	D x H
SH37-12075	12" x 75"
SH37-12087	12" x 87"
SH37-18075	18" x 75"
SH37-18087	18" x 87"
SH37-24075	24" x 75"
SH37-24087	24" x 87"

Perforated Panel

SH38

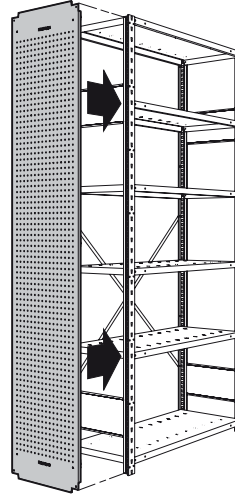

Perforated panel for end of aisle unit;
Holes at every 1 inch c/c;
Compatible with WM94, WM95, WM96, WM97, WM98 and WM99 hooks;
Fast and easy hook-on assembly;
Polished look;
Compatible with some multi-level shelving applications. Contact our customer service.

Product #	D x H
SH38-12075	12" x 75"
SH38-12087	12" x 87"
SH38-18075	18" x 75"
SH38-18087	18" x 87"
SH38-24075	24" x 75"
SH38-24087	24" x 87"

Perforated Back Panel

SR39



Perforated panel for shelving back;
Easy to install;
Compatible with SH31 back panels;
Installs on the back of an existing shelving unit;
Holes at every 1 inch c/c;
Compatible with WM94, WM95, WM96, WM97 and WM99 hooks;

Panel combinations :
- 75" H posts (39" + 39")
- 87" H posts (39" + 51")
- 99" H posts (51" + 51")

Compatible with the upright SR with the perforated surface.

Product #	W x H
SR39-3639	36" x 39"
SR39-3651	36" x 51"
SR39-4239	42" x 39"
SR39-4251	42" x 51"
SR39-4839	48" x 39"
SR39-4851	48" x 51"

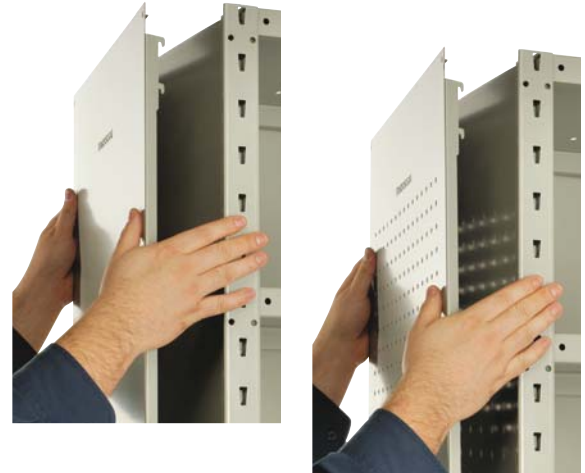

Back or Side Louvered Panel

SH65 / SH66

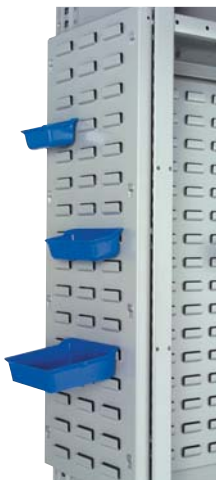

SH65 louvered panel for back of shelving : installs on the inside of the shelving unit, between two shelves;

SH66 louvered panel for side of shelving : installs on either the inside or the outside of the upright;

Simple assembly, no tools required;

Used for hanging RG20 bins;

Compatible with all brands of plastic bins offered on the market that are equipped with a hanging lip.

Back	W x H	Side	D x H
SH65-3621	36" x 21"	SH66-1221	12" x 21"
SH65-3633	36" x 33"	SH66-1233	12" x 33"
SH65-4221	42" x 21"	SH66-1821	18" x 21"
SH65-4233	42" x 33"	SH66-1833	18" x 33"
SH65-4821	48" x 21"	SH66-2421	24" x 21"
SH65-4833	48" x 33"	SH66-2433	24" x 33"

Flipper Door

SH85



Full-width handle;

Standard lock included;

14" high door that will allow you to store folders. Also available : 16" high door which will allow you to store binders;

Installs between 2-SH20 shelves;

SH52 dividers can be installed;

Door heights available : 14", 16", 17" and 18";

Order by adding the door height to the part #.
Ex. : SH85-361816L3.

Product #	Width
SH85-3618_L3	36"
SH85-4218_L3	42"
SH85-4818_L3	48"
SH85-3624_L3	36"
SH85-4224_L3	42"
SH85-4824_L3	48"



Industrial Shelving Accessories

Doors



Doors open 180°, with recessed lock and handle;

To receive a safety hasp instead of a standard lock, order SH40-XXXXLP instead of SH40-XXXXL3;

Simple and fast assembly;

Frame spaced to allow for installation of Rousseau modular drawers;

Compatible with Rousseau Spider® shelving only.

Product #	W x H
SH40-3639L3	36" x 39"
SH40-3675L3	36" x 75"
SH40-3687L3	36" x 87"
SH40-3699L3	36" x 99"
SH40-4239L3	42" x 39"
SH40-4275L3	42" x 75"
SH40-4287L3	42" x 87"
SH40-4299L3	42" x 99"
SH40-4839L3	48" x 39"
SH40-4875L3	48" x 75"
SH40-4887L3	48" x 87"
SH40-4899L3	48" x 99"



SHQ0010

SH40

Glass Doors



Doors with glass panels ensure you can see contents;

Surface made of polycarbonate with excellent impact resistance;

Doors open 180°, with recessed lock and handle;

To receive a safety hasp instead of a standard lock, order SH42-XXXXLP instead of SH42-XXXXL3;

Simple and fast assembly;

Frame spaced to allow for installation of Rousseau modular drawers;

Compatible with Rousseau Spider® shelving only.

Product #	W x H
SH42-3639L3	36" x 39"
SH42-3675L3	36" x 75"
SH42-3687L3	36" x 87"
SH42-3699L3	36" x 99"
SH42-4239L3	42" x 39"
SH42-4275L3	42" x 75"
SH42-4287L3	42" x 87"
SH42-4299L3	42" x 99"
SH42-4839L3	48" x 39"
SH42-4875L3	48" x 75"
SH42-4887L3	48" x 87"
SH42-4899L3	48" x 99"



SHQ0011 SHQ0012

Miscellaneous Rails

Clothes Hanging Rail

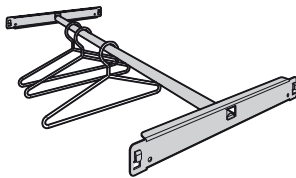

80 lb capacity per rail;

Simple and fast installation;

Installs by hooking to the shelving posts;

Includes one bar with a 1" diameter and 2 adaptors ;

Note : Because of space required under the clothes rail, it is not recommended for use on multi-level shelving installations.

Product #	W x D
SH70-3618	36" x 18"
SH70-3624	36" x 24"
SH70-4218	42" x 18"
SH70-4224	42" x 24"
SH70-4818	48" x 18"
SH70-4824	48" x 24"



SH70

Spool Support

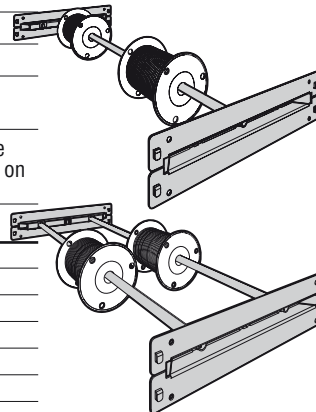

Optimizes storage of spools in shelving;

Offered with one or two rails;

50 lb capacity per rail, 100 lb total per double rail;

Rail(s) with 3/4" diameter, compatible with most spools;

Design allows for pivoting of rail to facilitate changing spools;

Combinations possible for different sized spools.

Product #	W x D	# of Rails
SH72-3612-01	36" x 12"	1 rail
SH72-3618-01	36" x 18"	1 rail
SH72-3618-02	36" x 18"	2 rails
SH72-3624-01	36" x 24"	1 rail
SH72-3624-02	36" x 24"	2 rails
SH72-4212-01	42" x 12"	1 rail
SH72-4218-01	42" x 18"	1 rail
SH72-4218-02	42" x 18"	2 rails
SH72-4224-01	42" x 24"	1 rail
SH72-4224-02	42" x 24"	2 rails
SH72-4812-01	48" x 12"	1 rail
SH72-4818-01	48" x 18"	1 rail
SH72-4818-02	48" x 18"	2 rails
SH72-4824-01	48" x 24"	1 rail
SH72-4824-02	48" x 24"	2 rails

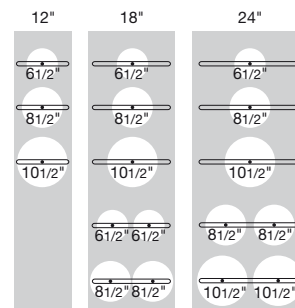

Industrial Shelving Accessories

SHELVING

Vinyl Rub-on Identification Decal

WM91



Allows you to easily identify where tools are to be positioned on the perforated panel (SH38, SH39 and SR39);

The contrasting color provides fast retrieval and shows if tools are missing, and which ones;

Efficient help for 5S management;

Sold in rolls 2 feet wide and 8 feet long.

Product #

WM91-01J

Multiple Tool Holder

WM94

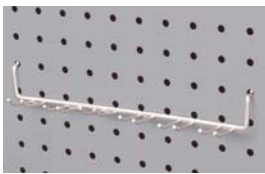

Used for SH38, SR39 and SH39 perforated panels to hang accessories or tools.

Product # W x H

WM94-01 9" x 1 1/2"

Straight Arm Hooks

WM96

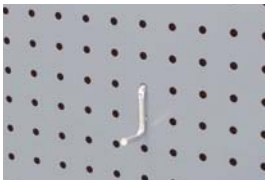

Used for SH38, SR39 and SH39 perforated panels to hang accessories or tools;

Sold in packs of 20.

Product # Depth

WM96-150 1 1/2"

Double Back Single and Double Hooks WM98 / WM99



Used for SH38, SR39 and SH39 perforated panels to hang accessories or tools;

Sold in packs of 10.

Product # Depth Type

WM98-03	3"	Single
WM98-05	5"	Single
WM99-03	3"	Double
WM99-05	5"	Double

Screwdriver Holder

WM95



Used for SH38, SR39 and SH39 perforated panels to hang screwdrivers;

May store up to 6 screwdrivers.

Product # W x D x H

WM95-01 9" x 1 1/2" x 1 3/4"

Single Loop Hooks

WM97



Used for SH38, SR39 and SH39 perforated panels to hang accessories or tools;

Sold in packs of 20.

Product # Diameter

WM97-150	1 1/2"
WM97-200	2"

Plastic Bin Rail

SH62

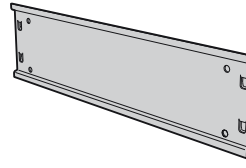

Very useful at ends of aisles. Fast hook-on assembly;

Ideal for all brands of bins from 5" to 7" high;

Bins sold separately.

Product # Depth

SH62-18	18"
SH62-24	24"

Plastic Bin



RG20



Makes storing, moving and inventory of small parts easier. Lightweight and resistant;

Edge at 45° angle for easy identification and easy removal of parts;

Compatible with louvered panels (SH65, SH66, WM55) and plastic bin rails (SH62 and WM28);

6" bins can be partitioned.

Dimensions			Bin	Product # Partition	Divider
W	D	H			
3"	3"	2"	RG20-030302	-	-
4"	3"	2"	RG20-040302	-	-
6"	3"	2"	RG20-060302	RG22-0302	-
6"	6"	2"	RG20-060602	RG22-0602	RG24-0602
3"	3"	3"	RG20-030303	-	-
4"	3"	3"	RG20-040303	-	-
6"	3"	3"	RG20-060303	RG22-0303	-
6"	6"	3"	RG20-060603	RG22-0603	RG24-0603

NOTE

Compatible with perforated panels with 1/4" holes at every 1" c/c. These panels are among the most popular on the market.



SHQ0013
Unit with closed welded upright



SHQ0014
Unit with SH37 finishing panel



SHQ0015
Unit with SH38 perforated panel

Industrial Shelving Accessories

Modular Drawers and Roll-out Shelves

Heavy-Duty Modular Drawer for Shelving

RF32



400 lb capacity, 100% extension;

Heavy-duty construction;

Easy to install;

Vast choice of accessories offered to adapt to your storage needs;

Available drawer heights : 3", 4", 5", 6", 7", 8", 9", 10", 12" and 14";

Order by adding the drawer height to the part #.
Ex. : RF32-362406;

For modular drawers with layouts,

SEE PAGES 151-155

SEE PAGES 137-150

Product #	W x D
RF32-3618	36" x 18"
RF32-3624	36" x 24"
RF32-4218	42" x 18"
RF32-4224	42" x 24"
RF32-4818	48" x 18"
RF32-4824	48" x 24"

Heavy-Duty Front Access Roll-Out Shelf

RF41



400 lb capacity, 100% extension;

Heavy-duty construction;

Easy to install;

Painted steel with 3" edges on sides and back;

Height : 6";

Full access to contents.

Product #	W x D
RF41-3618	36" x 18"
RF41-3624	36" x 24"
RF41-4218	42" x 18"
RF41-4224	42" x 24"
RF41-4818	48" x 18"
RF41-4824	48" x 24"

Heavy-Duty 3-Sided Access Roll-Out Shelf

RF45



400 lb capacity, 100% extension;

Heavy-duty construction;

Easy to install;

Galvanized steel with 1 1/2" edge on back;

Height : 5";

May serve as work surface.

Product #	W x D
RF45-3618	36" x 18"
RF45-3624	36" x 24"
RF45-4218	42" x 18"
RF45-4224	42" x 24"
RF45-4818	48" x 18"
RF45-4824	48" x 24"

Mounting Brackets for Spider® Shelving

RE30

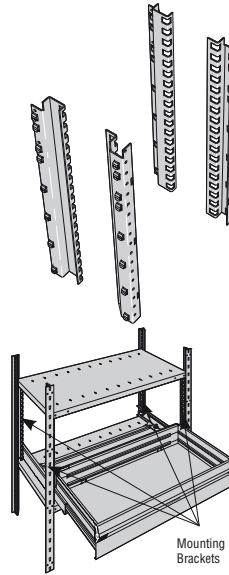

Easy hook-on assembly;

Standard heights : 18", 24", 30", 34", 36", 46" and 48";

The mounting bracket kit is compatible with all drawer widths for Rousseau shelving (36", 42" and 48");

Each kit includes 2 front and 2 rear mounting brackets and all necessary hardware;

Holes at every 1" c/c for drawer adjustment;

Two mounting bracket sets may be stacked simply by installing a shelf between them;

34" high mounting brackets are used with 39" posts or doors;

To order mounting brackets of non-standard heights, contact our customer service representative.

Product #	Height
RE30-18	18"
RE30-24	24"
RE30-30	30"
RE30-34	34"
RE30-36	36"
RE30-46	46"
RE30-48	48"

Shelving units with drawers must be anchored to the ground.

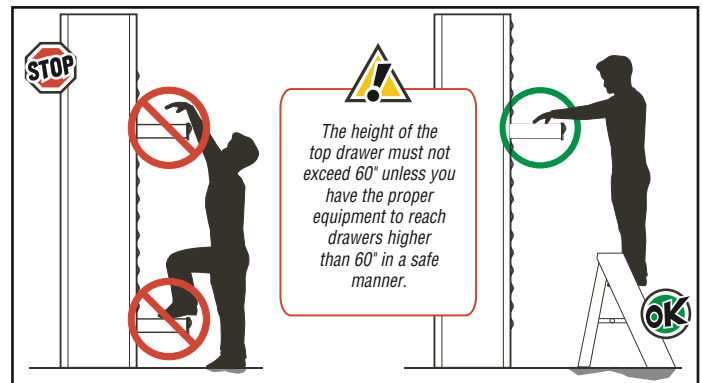

The height of the top drawer must not exceed 60" unless you have the proper equipment to reach drawers higher than 60" in a safe manner.

Heavy-Duty 3-Sided Access Roll-Out Shelf

RF45

Filler

RE90

400 lb capacity, 100% extension;

Heavy-duty construction;

Easy to install;

Galvanized steel with 1 1/2" edge on back;

Height : 5";

May serve as work surface.

Product #	W x D
RF45-3618	36" x 18"
RF45-3624	36" x 24"
RF45-4218	42" x 18"
RF45-4224	42" x 24"
RF45-4818	48" x 18"
RF45-4824	48" x 24"

Installs with an adhesive strip under the bank of drawers;

Meets aesthetic requirements of certain work environments (hospitals, offices, etc.);

Offered for Rousseau Spider® and spacesaver shelving only;

For Spacesaver shelving, order RE90-XX02 instead of RE90-XX01.

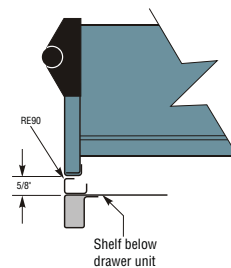

Product #	W x H
RE90-3601	36" x 5/8"
RE90-4201	42" x 5/8"
RE90-4801	48" x 5/8"



Industrial Shelving Accessories

Locking and Security Mechanisms

SHELVING

Vertical Security Bar

RE80



Locks a bank of drawers in shelving with either a key or a padlock;

To receive a safety hasp instead of a standard lock, order RE80-XXLPA instead of RE80-XXL3A; Safety hasp for padlock is located at the top of the bar to facilitate access;

Covers a bank of drawers from 18" to 48" high; Easy hook-on assembly;

Possible to install more than one bar on the same bracket for different users;

Installs on the right side;

36" high bar is compatible with 34" high mounting brackets and 48" high bar is compatible with 46" high mounting brackets;

Order by completing the product number with the type of key;

Offered for Rousseau Spider® shelving. For Spacesaver shelving, order RE81-XXXXA instead of RE80-XXXXA.



Product #	Height
RE80-18L3A	18"
RE80-24L3A	24"
RE80-30L3A	30"
RE80-36L3A	36"
RE80-48L3A	48"

Lock-out Mechanism

RF85



For both drawers and roll-out shelves; Locks drawers and roll-out shelves in open position; Activated manually, only when required; No interference with drawer accessories.

Product #
RF85

Drawer Lock

L3



Compatible with all drawer dimensions; Does not affect usable drawer space; Easy to retrofit;

Order by adding L3 to drawer or partitioning model number. Ex. : RF32-362406L3.

Product #
L3



Integrated Lock-in Mechanism

PATENTED **A**



Activated by tilting the handle up;

Allows user to open the drawer and the roll-out shelf with one hand only;

Close by simply pushing it;

Stops drawer and roll-out shelf from opening on their own;

Easy to retrofit;

Order by adding A to the drawer or partitioning model number or roll-out shelf. Ex. : RF32-362406A.

Product #
A

Econo Lock-in Mechanism

B

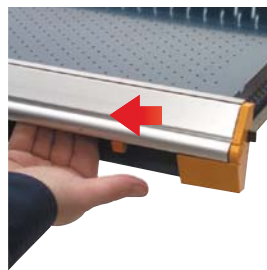

Activated with the right hand by sliding the mechanism with thumb;

Drawer and roll-out shelf closes without having to reactivate the slide mechanism;

Stops drawer and roll-out shelf from opening on their own;

Easy to retrofit;

Order by adding B to the drawer or partitioning model number or roll-out shelf. Ex. : RF32-362406B.

Product #
B

Security Panel

RF91

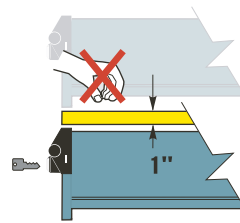

Blocks access between two drawers or two banks of drawers;

Usable space in the bank of drawers is reduced by 1";

Installed between two drawers.

Product #	W x D
RF91-3618	36" x 18"
RF91-3624	36" x 24"
RF91-4218	42" x 18"
RF91-4224	42" x 24"
RF91-4818	48" x 18"
RF91-4824	48" x 24"

Industrial Shelving Components

Structural Components

Post

SR10 / SH10

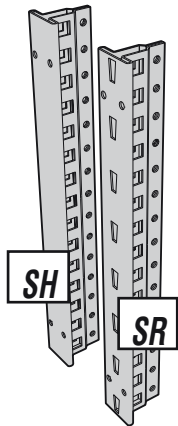

Tubular T-shape; up to 7 fixing zones;
Perforations on sides at every 1" c/c for adjusting shelves;
14 gauge steel;
Choose either :
- The universal SR10 post with the perforated surface to add Mini-Racking or two-level shelving
- The shelving SH10 post with the smooth finish surface for enhanced appearance

SR universal post	SH shelving post	Height
SR10-039	SH10-039	39"
SR10-051	SH10-051	51"
SR10-075	SH10-075	75"
SR10-087	SH10-087	87"
SR10-099	SH10-099	99"
SR10-111	SH10-111	111"
SR10-123	SH10-123	123"

Other dimensions available. Contact your customer service representative.

NOTE The unique shape of the Spider® post is a Rousseau Metal Inc. trademark.

Welded Open Upright

SR11 / SH11



Upright with factory welded side braces;
Fast assembly.

SR universal post	SH shelving post	D x H
SR11-120752	SH11-120752	12" x 75"
SR11-120872	SH11-120872	12" x 87"
SR11-120992	SH11-120992	12" x 99"
SR11-180752	SH11-180752	18" x 75"
SR11-180872	SH11-180872	18" x 87"
SR11-180992	SH11-180992	18" x 99"
SR11-240752	SH11-240752	24" x 75"
SR11-240872	SH11-240872	24" x 87"
SR11-240992	SH11-240992	24" x 99"

Other dimensions available. Contact your customer service representative.

Side Braces

SH34

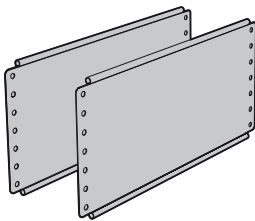

Sold in pairs;
Allow upright assemblies to be fastened in a "ladder-like" manner for easier assembly;
Recommendations :
- 1 pair per upright assembly up to 99" in height
- For upright assemblies over 99" in height, please refer to the S58 technical sheet or contact your customer service representative.

Product #	Depth
SH34-12	12"
SH34-15	15"
SH34-18	18"
SH34-24	24"
SH34-30	30"

Welded Closed Upright

SR12 / SH12



Upright with full-height factory welded parts;
Fast assembly.

SR universal post	SH shelving post	D x H
SR12-12075	SH12-12075	12" x 75"
SR12-12087	SH12-12087	12" x 87"
SR12-12099	SH12-12099	12" x 99"
SR12-18075	SH12-18075	18" x 75"
SR12-18087	SH12-18087	18" x 87"
SR12-18099	SH12-18099	18" x 99"
SR12-24075	SH12-24075	24" x 75"
SR12-24087	SH12-24087	24" x 87"
SR12-24099	SH12-24099	24" x 99"

Other dimensions available. Contact your customer service representative.

Back Brace

SH33

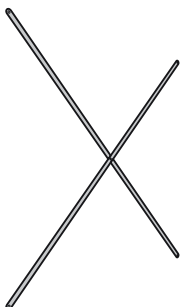

"X" shaped, factory assembled brace;
Easy to install;
Recommendations :
- 1 pair per upright assembly up to 99" in height
- 2 pairs for posts over 99" in height.
Please refer to the S58 technical sheet or contact your customer service representative.

Product #	Width
SH33-36	36"
SH33-42	42"
SH33-48	48"

Corner Gussets

SH35

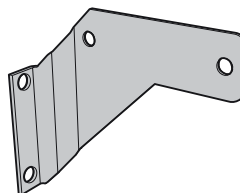

Replace back brace for full access to front and back of shelving unit;
14 gauge steel;
Each set includes 4 gussets. Min. of 3 sets per unit;
Note : Not to be used on units over 99" H or for multi-level shelving.

Product #
SH35

Industrial Shelving Components

SHELVING

Side Panel

SH30

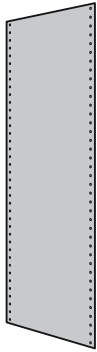

Panel combinations :

- 75"H posts (39" + 39")
- 87"H posts (39" + 51")
- 99"H posts (51" + 51")
- 111"H posts (39" + 39" + 39")
- 123"H posts (39" + 39" + 51")

Product #	D x H
SH30-1239	12" x 39"
SH30-1251	12" x 51"
SH30-1539	15" x 39"
SH30-1551	15" x 51"
SH30-1839	18" x 39"
SH30-1851	18" x 51"
SH30-2439	24" x 39"
SH30-2451	24" x 51"

Back Panel

SH31

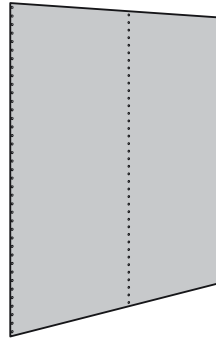

Panel combinations :

- 75"H posts (39" + 39")
- 87"H posts (39" + 51")
- 99"H posts (51" + 51")
- 111"H posts (39" + 39" + 39")
- 123"H posts (39" + 39" + 51")

Product #	W x H
SH31-3639	36" x 39"
SH31-3651	36" x 51"
SH31-4239	42" x 39"
SH31-4251	42" x 51"
SH31-4839	48" x 39"
SH31-4851	48" x 51"

Shelf Front or Front Base

SH28

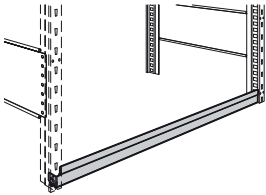

Same component for both applications;
Fast hook-on installation;

Note: Front base is always included with closed shelving models.

Product #	W x H
SH28-3602	36" x 2"
SH28-4202	42" x 2"
SH28-4802	48" x 2"
SH28-3605	36" x 5"
SH28-4205	42" x 5"
SH28-4805	48" x 5"

Structural Perforated Back Panel

SH39

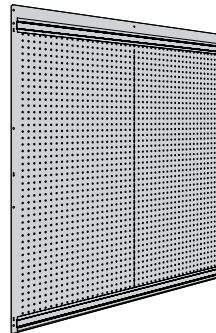

Perforated panel for shelving back;

Integrated part of the shelving structure;

Holes at every inch c/c;

Compatible with WM94, WM95, WM96, WM97, WM98 and WM99 hooks;

Panel combinations :

- 75" H posts (39" + 39")
- 87" H posts (39" + 51")
- 99" H posts (51" + 51")

Note : Used without the SH31 back panels.

Product #	W x H
SH39-3639	36" x 39"
SH39-3651	36" x 51"
SH39-4239	42" x 39"
SH39-4251	42" x 51"
SH39-4839	48" x 39"
SH39-4851	48" x 51"

Installation Accessories

Floor Anchor Plate

SH45

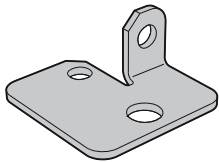

Sold individually;

Attaches to the post for anchoring shelving sections to the floor. Distributes the load on a larger surface and protects the floor;

12 gauge galvanized steel.

Product #
SH45

Floor Anchoring Hardware

SH47

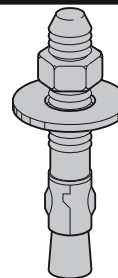

Used for anchoring shelving to the floor;

Includes 4 cement screws.

Product #
SH47-04

Shim Plate

SH46

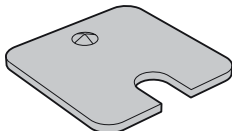

Sold individually;

Evens out shelving units on uneven surfaces. Slides under SH45 floor anchor plate;

12 or 16 gauge galvanized steel.

Product #	Thickness
SH46-12	12 gauge (0,100")
SH46-16	16 gauge (0,060")

Wall Spacer

SR47

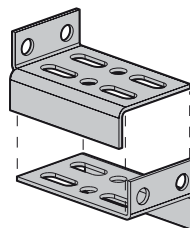

Designed to anchor shelving to the wall;

Adjusts from 3" to 4";

Wall anchoring hardware not included (holes are 5/16" in diameter).

Product #
SR47-0304

Industrial Shelving Components

Shelves and Shelf Accessories

Box Shelf

SH20

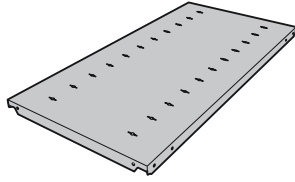

Box-type shelf with front and rear edges roll-formed and welded;
20 gauge steel, 1 1/4" thick;
4 sturdy and compact SH60 clips included;
Perforations for dividers at every 3" c/c;
Others dimensions available Contact your customer service representative.

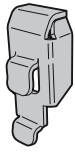

SH60
(4 clips)

Product #	W x D
SH20-3612	36" x 12"
SH20-3615	36" x 15"
SH20-3618	36" x 18"
SH20-3624*	36" x 24"
SH20-4212	42" x 12"
SH20-4215	42" x 15"
SH20-4218	42" x 18"
SH20-4224	42" x 24"
SH20-4812	48" x 12"
SH20-4815	48" x 15"
SH20-4818	48" x 18"
SH20-4824	48" x 24"



* Also offered with a double fold on the sides.

SHELVING

Shelf Load Capacity

Shelving load capacity tests are based on ANSI MH28.1 Shelving Manufacturer Association (SMA) standards. Capacities incorporate a safety factor and are valid for an equally distributed load. Capacities are indicated in pounds.

** 800 lb capacity with SH22 side shelf reinforcers or shelf with double fold on the side.

Dimensions W x D	Reinforcement Type		
	Medium-Duty Capacity Without Reinforcer	Heavy-Duty Capacity Central Reinforcer	Extra Heavy-Duty Capacity Double Reinforcer
36" x 12"	750	—	—
36" x 15"	775	—	—
36" x 18"	800	1000	1100
36" x 24"	625**	1050	1100
42" x 12"	650	—	—
42" x 15"	650	—	—
42" x 18"	650	850	1050
42" x 24"	650	875	1050
48" x 12"	550	—	—
48" x 15"	550	—	—
48" x 18"	575	725	1025
48" x 24"	600	750	1050

Front Shelf Reinforcer

SH24

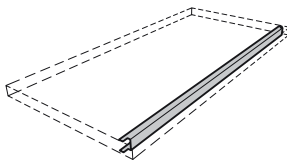

"C" shaped reinforcer. Used when shelves must support heavier loads in front. Note : The reinforcer increases shelf sturdiness, not capacity.

Product #	Width
SH24-36	36"
SH24-42	42"
SH24-48	48"

Side Shelf Reinforcers

SH22

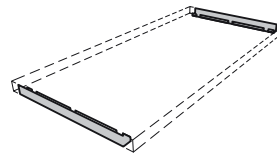

2 "L" shaped reinforcers for attachment on each side of a shelf. Used when shelves must support heavier loads.

Product #	Depth
SH22-18	18"
SH22-24	24"

Double Shelf Supports

SH25

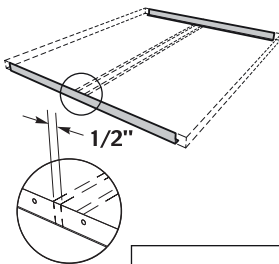

2 "L" shape supports. Used with two 15" shelves to obtain 30" depth (1/2" gap between shelves);

Total capacity : 750 lb.

Product #	Depth
SH25-30	30"

NOTE

The SH22, SH24 and SHC reinforcers as well as the SH25 double shelf supports are not factory installed on the SH20 box shelves.

Center Shelf Reinforcer

SHC

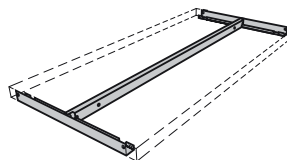

SH24 front shelf reinforcer combined with SH22 side reinforcers. Used when shelves must support heavier or more concentrated loads;

Note : An additional SH24 reinforcer should be ordered to obtain extra heavy-duty shelf capacity.

Product #	W x D
SHC1003	36" x 18"
SHC1004	36" x 24"
SHC1007	42" x 18"
SHC1008	42" x 24"
SHC1005	48" x 18"
SHC1006	48" x 24"

NOTE

Used when the shelves have to support higher loads, concentrated loads or when the visual is important.

Mini-Racking Proposals



When ordering, model numbers must be completed as follows :

	Starter unit	Add-on unit	
BOLTED uprights	<u>D</u>	<u>A</u>	EXEMPLE : SR _ 5001
WELDED uprights	<u>E</u>	<u>B</u>	
<u>S</u> Steel decking			Example : S R <u>D</u> 5 0 0 1 <u>S</u> for a starter unit bolted uprights, including steel decking.
<u>W</u> Wire decking			
— Without decking			

Mini-Racking with Choice of Decking

The beams are designed to receive steel shelves (SR40, SH20), wire decking (SR42) or wood panels at least 5/8" thick.

Steel

To order a unit with steel shelves, complete the product number with an **S**.

Wire

To order a unit with wire shelves, complete the product number with a **W**.

Not compatible with 18" depth.

For Wood Panels

To order a unit without decking (Ex. : for use with wood panels) leave the product number as is.

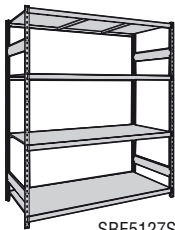

SRE5127S Starter



SRB5127S Add-on



SRE5127W Starter



SRB5127W Add-on



SRE5127 Starter



SRB5127 Add-on

Mini-racking with Medium-Duty Beams

Dimensions			Number of Levels		Dimensions			Number of Levels	
W	D	H	3	4	W	D	H	3	4
48"	18"	75"	SR_5001_	SR_5021_	72"	18"	75"	SR_5101_	SR_5121_
			SR_5002_	SR_5022_				SR_5102_	SR_5122_
			SR_5003_	SR_5023_				SR_5103_	SR_5123_
			SR_5004_	SR_5024_				SR_5104_	SR_5124_
	24"	87"	SR_5005_	SR_5025_		SR_5105_	SR_5125_		
			SR_5006_	SR_5026_		SR_5106_	SR_5126_		
			SR_5007_	SR_5027_		SR_5107_	SR_5127_		
			SR_5008_	SR_5028_		SR_5108_	SR_5128_		
60"	18"	75"	SR_5051_	SR_5071_	24"	99"	—	SR_5130_	
			SR_5052_	SR_5072_			—	SR_5131_	
			SR_5053_	SR_5073_			—	SR_5132_	
			SR_5054_	SR_5074_			—	—	
	24"	87"	SR_5055_	SR_5075_	*Models are compatible with double shelving units with same depth.				
			SR_5056_	SR_5076_					
			SR_5057_	SR_5077_					
			SR_5058_	SR_5078_					
24"	99"	—	SR_5080_						
		—	SR_5081_						
48"	—	SR_5082_							

Tie bars

Models include 1 to 3 tie bars, depending on their dimensions.

NOTE For capacity chart.

SEE PAGE 76



SRE5072S

Depth	Medium-Duty Beams		
	Number of Tie Bars		
	Steel	Wire	Wood Panels
18"	1	NA	1
24"	1	1	1
36"	1	1	2
48"	1	1	3

Mini-Racking Proposals

MINI-RACKING

Mini-racking with Heavy-Duty Beams				
Dimensions			Number of levels	
W	D	H	3	4
72"	18"	75"	SR_5151_	SR_5171_
			SR_5152_	SR_5172_
			SR_5153_	SR_5173_
			SR_5154_	SR_5174_
	18"	87"	SR_5155_	SR_5175_
			SR_5156_	SR_5176_
			SR_5157_	SR_5177_
			SR_5158_	SR_5178_
	36" *	99"	—	SR_5180_
			—	SR_5181_
			—	SR_5182_
			—	—
96"	18"	75"	SR_5201_	SR_5221_
			SR_5202_	SR_5222_
			SR_5203_	SR_5223_
			SR_5204_	SR_5224_
	18"	87"	SR_5205_	SR_5225_
			SR_5206_	SR_5226_
			SR_5207_	SR_5227_
			SR_5208_	SR_5228_
	36" *	99"	—	SR_5230_
			—	SR_5231_
			—	SR_5232_
			—	—

*Models are compatible with double shelving units with same depth.

Heavy-Duty Beams				
Number of Tie Bars				
Width	Depth	Steel	Wire	Wood Panels
72"	18"	1	NA	2
	24"	1	1	2
	36"	1	1	3
	48"	1	1	3
96"	18"	1	NA	2
	24"	1	1	2
	36"	1	1	3
	48"	2	2	3

Tie bars

Models include 1 to 3 tie bars, depending on their dimensions.

NOTE For capacity chart.

SEE PAGE 76



Mini-Racking for Standard-Sized Wood Panels

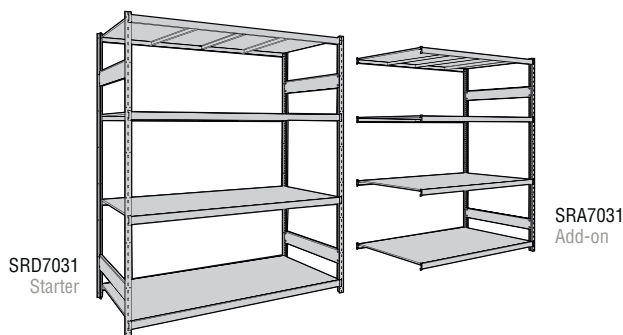

SRD7031 Starter

SRA7031 Add-on



SRE5376

Model dimensions are designed to reduce the need to cut wood panels;

4 long-span levels with heavy-duty beams;

Bolted uprights (require assembly).

Starter	Add-On	W x D x H
SRD7031	SRA7031	72" x 48 1/2" x 87"
SRD7032	SRA7032	72" x 48 1/2" x 99"
SRD7033	SRA7033	96 1/2" x 24" x 87"
SRD7034	SRA7034	96 1/2" x 24" x 99"
SRD7035	SRA7035	96 1/2" x 48" x 87"
SRD7036	SRA7036	96 1/2" x 48" x 99"
SRD7037	SRA7037	96 1/2" x 48 1/2" x 87"
SRD7038	SRA7038	96 1/2" x 48 1/2" x 99"

NOTE Wood decking are not provided by Rousseau.

Mini-Racking Accessories

MINI-RACKING

Single Divider

SR61

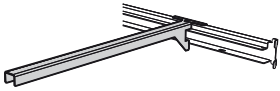

Divides those parts that lean vertically against the back of the Mini-racking;

Installs on medium-duty (SR21) or heavy-duty (SR22) beams;

Divider can be adjusted laterally (left to right) without tools;

Stays in position when load applied laterally;

Compatible with 24" deep shelving and deeper.

Product #	Depth
SR61-2401	24"

Double Divider

SR60

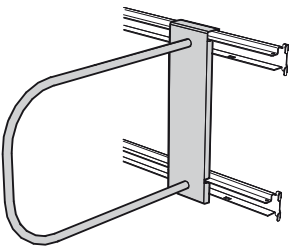

Supports parts and boxes that are stored vertically in a Mini-racking unit. Parts lean against "D" shape of the divider;

Attaches on two medium-duty (SR21) or two heavy-duty beams (SR22);

Space between the two beams must be 14" c/c;

Divider can be adjusted laterally (left to right) without tools;

Stays in position when load applied laterally;

Compatible with 24" deep shelving and deeper;

Designed to support lateral load.

Product #	D x H
SR60-2415	24" x 15"

Label Holder

NC32



Attaches to SR21 medium-duty or SR22 heavy-duty beams;

For use with self-adhesive labels only.

Product #	Width
NC32-3601	36"
NC32-4201	42"
NC32-4801	48"
NC32-6001	60"
NC32-6601	66"
NC32-7201	72"
NC32-9601	96"

Laminated Wood Top for Shelving

SR90



Designed to be installed between two shelving units;

Must be ordered with a pair of SH74 supports or used with a storage unit with work surface application.

Product #	W x D
SR90-6024A	60" x 24"
SR90-7224A	72" x 24"
SR90-9624A	96" x 24"

Hanging Rail

SR62

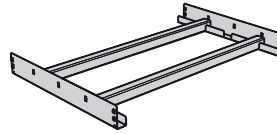
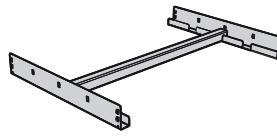

300 lb capacity per rail;

Installs on Spider® post with hooks, no bolts;

Includes security mechanism to keep from accidentally unhooking;

3 installation positions possible : one in the middle and two closer to the edges;

Compatible with SR63-02 hooks (not included);

Hooks pivot once installed on the rail. They can be put on and taken off the rail at all times, even when the rail is in place on the adaptors;

Rail and adaptors in galvanized steel.

Single Rail	W x D
SR62-601801	60" x 18"
SR62-602401	60" x 24"
SR62-603601	60" x 36"
SR62-721801	72" x 18"
SR62-722401	72" x 24"
SR62-723601	72" x 36"
SR62-961801	96" x 18"
SR62-962401	96" x 24"
SR62-963601	96" x 36"

Double Rail	W x D
SR62-602402	60" x 24"
SR62-603602	60" x 36"
SR62-722402	72" x 24"
SR62-723602	72" x 36"
SR62-962402	96" x 24"
SR62-963602	96" x 36"

Hook for Rail

SR63



50 lb capacity per hook;

Hooks pivot once installed on the SR62 rail;

Can be put on and taken off even when the rail is in place on the adaptors.

Product #	D x H
SR63-02	2 1/2" x 5"

Back-to-Back Spacers

SR48

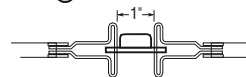

Sold in pairs;

Used to attach two sections of Mini-Racking, back-to-back, with a 1" space between posts for beam adjustment .

Product #
SR48

Wood Top Support

SH74

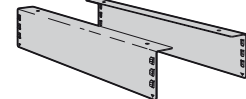
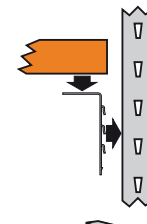

Sold in pairs;

Installed with hook system, without tools, onto the sides of SH or SR uprights;

Designed to support a SR90 laminated wood top between two shelving units.

Product #	Width
SH74-24	24"

Mini-Racking Components

Structural Components

Post

SR10



Tubular T-shape; up to 7 fixing zones;
Perforations on front side, every 2" c/c, for beam adjustment;
14 gauge steel.

Product #	Height
SR10-039	39"
SR10-051	51"
SR10-075	75"
SR10-087	87"
SR10-099	99"
SR10-111	111"
SR10-123	123"

Welded Mini-Racking Upright Assembly

SR13

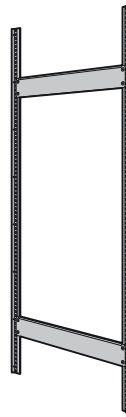

Two heavy-duty ladder braces, factory welded onto two universal posts.

Product #	D x H
SR13-180752	18" x 75"
SR13-180872	18" x 87"
SR13-240752	24" x 75"
SR13-240872	24" x 87"
SR13-240992	24" x 99"
SR13-360752	36" x 75"
SR13-360872	36" x 87"
SR13-360992	36" x 99"
SR13-480752	48" x 75"
SR13-480872	48" x 87"
SR13-480992	48" x 99"

Other heights available. Please contact your customer service representative.

Mini-Racking Ladder Braces

SR30 / SR32

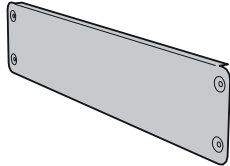

Single ladder brace for 15" to 24" depths

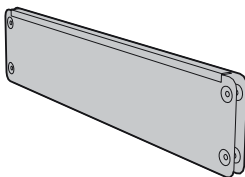

Double, interlocked ladder brace for 30" to 48 1/2" depths

Sold in pairs;

Recommendations:

- 1 pair per upright assembly up to 99" in height
- For upright assemblies over than 99" in height, please contact your customer service representative

For depths of 30", 36", 48" and 48 1/2", ladder braces interlock as shown. Pairs of ladder braces supplied with these models are double ladder braces.

Product #	Depth
SR30-15	15"
SR30-16	16"
SR30-18	18"
SR30-24	24"
SR30-30	30"
SR30-32	32"
SR30-36	36"
SR30-48	48"
SR32-4801*	48 1/2"

* The SR32 ladder brace is used to accommodate 48" D wood panels without cutting.

NOTE 15", 16", 30" and 32" ladder braces are suitable for record storage.



R5XEE-4001

MINI-RACKING

Mini-Racking Components

Beams and Tie Bars

MINI-RACKING

Medium-Duty Beams

SR21

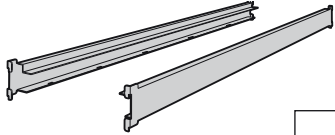
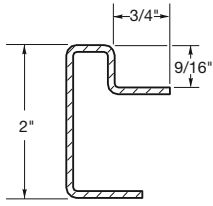

Sold in pairs;
14 gauge steel;
Attach to the front of the post. Height adjustment every 2" c/c;
Held in place with two safety clips.

Product #	W x H
SR21-36	36" x 2"
SR21-42	42" x 2"
SR21-48	48" x 2"
SR21-60	60" x 2"
SR21-66	66" x 2"
SR21-72	72" x 2"

NOTE 42" and 66" beams are suitable for record storage.

SEE PAGE 169

Medium-Duty Tie Bar

SR25 / SR26

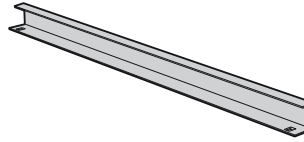

Hook to the inside of SR21 beams.

Product #	Depth
SR25-15	15"
SR25-16	16"
SR25-18	18"
SR25-24	24"
SR25-30	30"
SR25-32	32"
SR25-36	36"
SR25-48	48"
SR26-4801*	48 1/2"

NOTE

15", 16", 30" and 32" tie bars are suitable for record storage.

SEE PAGE 169

* The SR26 tie bar is used with SR32 ladder braces to accommodate a 48" D panel without cutting.

Beam Capacity Chart

*Shelving load capacity tests are based on ANSI MH28.2 Shelving Manufacturer Association (SMA) standards. Capacities incorporate a safety factor and are valid for an equally distributed load. Capacities are indicated in pounds.

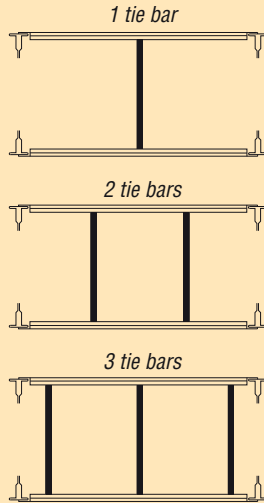

Medium-Duty Beams

Decking Type	Depth	Width						Number of Tie Bars	
		36"	42"	48"	60"	66"	72"		
Wood* Decking	15" to 24"	1000	1000	975	800	725	650	1	
	30" to 32"	1075	1025	925	775	700	625	2	
		36"	850	875	900	750	700	625	2
		48"	875	825	775	775	750	650	3
Steel* Decking	15" to 24"	900	900	900	800	750	650	1	
	30" to 48"	1125	1125	1000	800	750	650	1	
Wire Decking	24" to 48"	800	800	800	800	750	650	1	

Heavy-Duty Beams

Decking Type	Depth	Width			Number of Tie Bars	
		60"	72"	96"		
Wood* Decking	15" to 24"	1650	1600	1225	2	
	30" to 32"	1850	1575	1225	2	
		36"	1750	1600	1225	3
		48"	1225	1225	1225	3
Steel* Decking	15" to 24"	1350	1350	1225**	1	
	30" to 48"	1925	1600	1225**	1	
Wire Decking	24" to 48"	1200	1200	1200**	1	

**96" x 48" dimensions with steel decking or wire decking require 2 tie bars.

Heavy-Duty Beams

SR22 / SR23

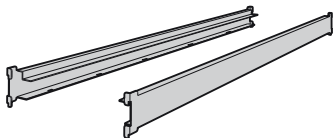
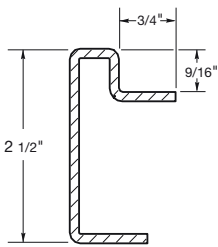

Sold in pairs;
12 gauge steel;
Attach to the front of the post. Height adjustment every 2" c/c;
Held in place with two safety clips.

Product #	W x H
SR22-60	60" x 2 1/2"
SR22-72	72" x 2 1/2"
SR22-96	96" x 2 1/2"
SR23-96*	96 1/2" x 2 1/2"

* SR23 beams can accommodate a 96" wide panel without cutting.

Heavy-Duty Tie Bar

SR27 / SR28

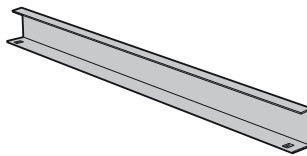

Hook to the inside of SR22 and SR23 beams.

Product #	Depth
SR27-15	15"
SR27-18	18"
SR27-24	24"
SR27-30	30"
SR27-32	32"
SR27-36	36"
SR27-48	48"
SR28-4801*	48 1/2"

* The SR28 tie bar is used with SR32 ladder braces to accommodate a 48" D panel without cutting.

Mini-Racking Components

Mini-Racking Decking

Steel Decking

SR40 / SH20



Triple folds on the sides and single fold at the front and back;
Steel decking improves shelf strength.



ATTENTION

To order depending on unit dimensions and for each level of shelving, order the appropriate quantity of shelves and the product number(s) specified in the chart.

Upright Assembly Depth	Beam Width													
	36"		42"		48"		60"		66"		72"		96"	
	Qty Required	Product #	Qty Required	Product #	Qty Required	Product #	Qty Required	Product #	Qty Required	Product #	Qty Required	Product #	Qty Required	Product #
15"	2	SR40-1815	+ 1	SR40-1815 SR40-2415	2	SR40-2415	+ 1	SR40-1815 SR40-2415	+ 2	SR40-1815 SR40-2415	3	SR40-2415	4	SR40-2415
16"	2	SR40-1816	+ 1	SR40-1816 SR40-2416	2	SR40-2416	+ 1	SR40-1816 SR40-2416	+ 2	SR40-1816 SR40-2416	3	SR40-2416	4	SR40-2416
18"	2	SR40-1818	+ 1	SR40-1818 SR40-2418	2	SR40-2418	+ 1	SR40-1818 SR40-2418	+ 2	SR40-1818 SR40-2418	3	SR40-2418	4	SR40-2418
24"	2	SR40-1824	+ 1	SR40-1824 SR40-2424	2	SR40-2424	+ 1	SR40-1824 SR40-2424	+ 2	SR40-1824 SR40-2424	3	SR40-2424	4	SR40-2424
36"	2	SH20-3618	+ 1	SH20-3618 SH20-3624	4	SH20-3612	4	SH20-3615	+ 2	SH20-3618 SH20-3624	4	SH20-3618	4	SH20-3624
48"	2	SH20-4818	+ 1	SH20-4818 SH20-4824	4	SH20-4812	4	SH20-4815	+ 2	SH20-4818 SH20-4824	4	SH20-4818	4	SH20-4824

These dimensions are suitable for Mini-racking and back-to-back shelving. For other dimension, please see the S52 technical guide.

NOTE For 30" and 32" deep units, contact your customer service representative.

Wire Decking

SR42

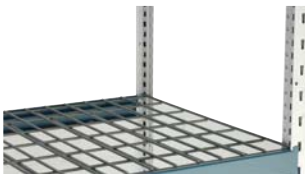

Wire decking fabricated from steel rods welded together;
Product meets fire code standards;
Wire decking offers an interesting alternative to steel decking;
Some dimensions are suitable for Mini-racking and back to back shelving. See the S52 technical guide.

ATTENTION

To order depending on unit dimensions and for each level of shelving, order the appropriate quantity of shelves and the product number(s) specified in the chart.

Upright Assembly Depth	Beam Width													
	36"		42"		48"		60"		66"		72"		96"	
	Qty Required	Product #	Qty Required	Product #	Qty Required	Product #	Qty Required	Product #	Qty Required	Product #	Qty Required	Product #	Qty Required	Product #
24"	2	SR42-1824	+ 1	SR42-1824 SR42-2424	2	SR42-2424	+ 1	SR42-1824 SR42-2424	+ 2	SR42-1824 SR42-2424	3	SR42-2424	4	SR42-2424
30"	2	SR42-1830	+ 1	SR42-1830 SR42-2430	2	SR42-2430	+ 1	SR42-1830 SR42-2430	+ 2	SR42-1830 SR42-2430	3	SR42-2430	4	SR42-2430
36"	2	SR42-1836	+ 1	SR42-1836 SR42-2436	2	SR42-2436	+ 1	SR42-1836 SR42-2436	+ 2	SR42-1836 SR42-2436	3	SR42-2436	4	SR42-2436
48"	2	SR42-1848	+ 1	SR42-1848 SR42-2448	2	SR42-2448	+ 1	SR42-1848 SR42-2448	+ 2	SR42-1848 SR42-2448	3	SR42-2448	4	SR42-2448

Wood Decking Dimensions

Wood panels must be cut according to the following dimensions :

- Nominal width of Mini-racking -11/16"
- 15" to 24" deep : Nominal depth of Mini-racking -7/8"
- 30" to 48" deep : Nominal depth of Mini-racking -5/8"

Ex. : For a unit 60" W x 24" D, the wood panel = 59 5/16" W x 23 1/8" D.

IMPORTANT

Wood panels are not provided by Rousseau.

Beams are designed for plywood or particleboard panels at least 5/8" thick.

IMPORTANT

Dimensions of 30", 36" and 48" deep units are suitable for Mini-racking and two back-to-back units (except for 96 1/2" W). Please see the S52 technical guide.

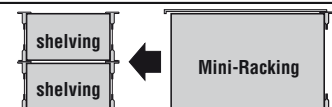

Modular Drawer in Shelving

DRAWER IN SHELVING



MAXIMIZE STORAGE CAPABILITY

Say goodbye to poorly lit shelves, backaches, and difficulty accessing materials caused by inadequate storage! Let us help you redesign your space.

As storage specialists, we recommend integrating Rousseau drawers with your shelving to get the most out of it. Opt for a hybrid and versatile system that has proved itself over and over for the past 25 years.

With their sturdy construction and distinctive appearance, Rousseau drawers add value to your existing equipment. The Rousseau modular drawer can be installed in over 35 brands of shelving on the market, making it possible to keep existing materials. A simple and economic solution... **Just think about it!**



CURRENT SITUATION

- 1 Top and bottom shelves used less and hard to reach.
- 2 Poor lighting at the back of shelves.
- 3 Visibility of items hampered by shelves blocking field of vision.
- 4 Unused space between shelves. Not optimized

RESULT : Items are harder to locate and taking inventory is more difficult.

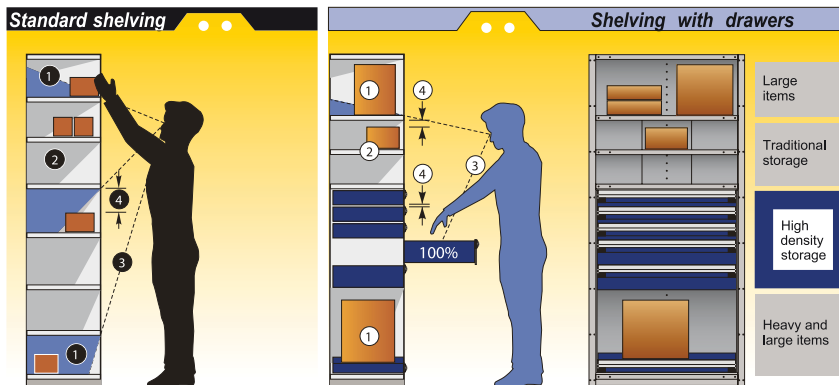

OUR RECOMMANDATIONS

- 1 More widely spaced shelves for larger items.
- 2 Close-set shelves positioned at eye level.
- 3 Objects are easy to locate in drawers that open 100%.
- 4 Use of space optimized, based on the size of stored items.

RESULT : Better organized storage, easy to inventory.

Modular Drawer in Shelving

The Rousseau Advantages

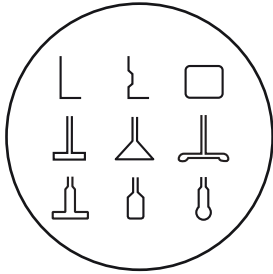

Can be installed in over 35 brands of shelving on the market. Easy and quick hook-on assembly for most brands of shelving.

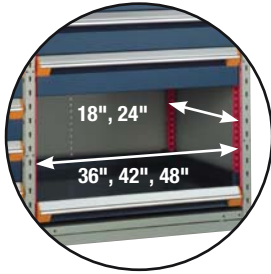

Several dimensions available : 36", 42" and 48" W by 18" and 24" D. Same brackets for different dimensions.



10 drawer heights and 7 side heights available.

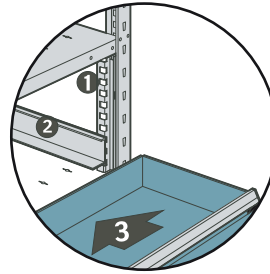

Easy and fast installation :

1. Hook brackets on;
2. Hook rails on;
3. Insert carriages and drawers.



400 lb capacity per drawer. Most durable drawer in the industry.

General Dimensions



Popular dimensions shown in red.

Index	Page(s)
Modular Drawer in Shelving	78 - 79
Proposals	80 - 81
Components	82 - 83
Accessories	84
Assembly and Security Recommendations	85

In Order To Save Space

Instead of building an addition onto your building, choose high density storage and optimize your investments!

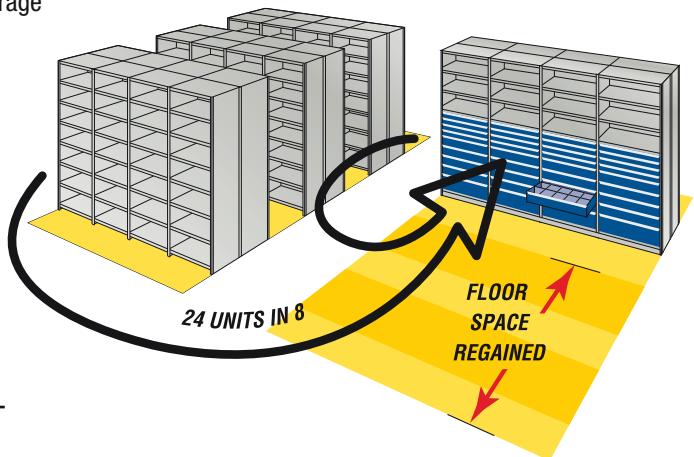
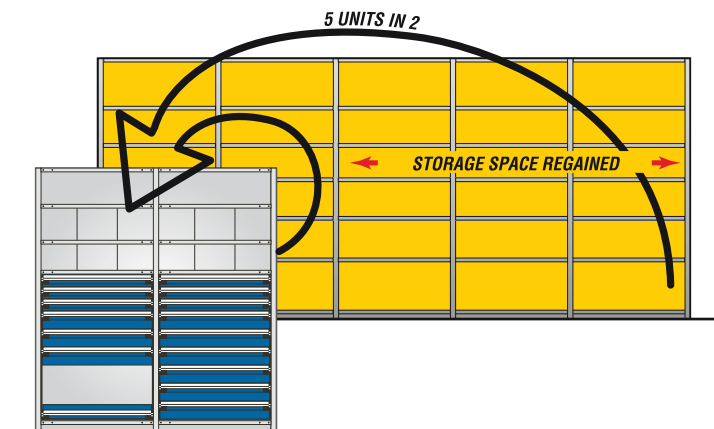

Ask our expert consultants for an in-depth survey of your potential savings.

Proposals

DRAWER IN SHELVING

Presented here are some of the most popular modular drawers in shelving models.

Rousseau modular drawers are adaptable to more than 35 brands of shelving available on the market;

All models include mounting brackets for Spider® shelving. Please specify the shelving brand when ordering.

SEE PAGE 63

IMPORTANT

Drawer partitions are included in models.

NOTE

For drawers without partitioning, complete the even number following the two last digits of the models.

Ex. : R5LEC-1801 with R5LEC-1802 without

NOTE Shelving must be ordered separately.

SEE PAGES 69-71



R5SEE-874811



Shelving with drawers must be anchored to the floor.

Number of Compartments (layout code)						
Drawer dimensions	36" x 18"	36" x 24"	42" x 18"	42" x 24"	48" x 18"	48" x 24"
3" to 5"	24 (0518)	30 (0524)	20 (0512)	30 (0524)	32 (0724)	40 (0732)
6" to 8"	8 (0304)	12 (0308)	12 (0308)	12 (0308)	10 (0405)	15 (0410)
9" and higher	6 (0203)	9 (0206)	6 (0203)	8 (0304)	8 (0304)	8 (0304)

NOTE For inside dimensions.

SEE PAGE 134-135

18" H Bank of Drawers for Shelving



R5LEE-1801

- 4 drawers :
- 3-4" drawers
 - 1-6" drawer

Product #	W x D
R5LEC-1801	36" x 18"
R5LEE-1801	36" x 24"
R5LGC-1801	42" x 18"
R5LGE-1801	42" x 24"
R5LHC-1801	48" x 18"
R5LHE-1801	48" x 24"

Note Shelving must be ordered separately.

24" H Bank of Drawers for Shelving



R5LEE-2401

- 5 drawers :
- 3-4" drawers
 - 2-6" drawers

Product #	W x D
R5LEC-2401	36" x 18"
R5LEE-2401	36" x 24"
R5LGC-2401	42" x 18"
R5LGE-2401	42" x 24"
R5LHC-2401	48" x 18"
R5LHE-2401	48" x 24"

Note Shelving must be ordered separately.

36" H Bank of Drawers for Shelving



R5LEE-3601

- 7 drawers :
- 3-4" drawers
 - 4-6" drawers

Product #	W x D
R5LEC-3601	36" x 18"
R5LEE-3601	36" x 24"
R5LGC-3601	42" x 18"
R5LGE-3601	42" x 24"
R5LHC-3601	48" x 18"
R5LHE-3601	48" x 24"

Note Shelving must be ordered separately.



R5LEE-3603

- 7 drawers :
- 4-4" drawers
 - 2-6" drawers
 - 1-8" drawer

Product #	W x D
R5LEC-3603	36" x 18"
R5LEE-3603	36" x 24"
R5LGC-3603	42" x 18"
R5LGE-3603	42" x 24"
R5LHC-3603	48" x 18"
R5LHE-3603	48" x 24"

Note Shelving must be ordered separately.

48" H Bank of Drawers for Shelving



R5LEE-4801

8 drawers :
- 8-6" drawers

Product #	W x D
R5LEC-4801	36" x 18"
R5LEE-4801	36" x 24"
R5LGC-4801	42" x 18"
R5LGE-4801	42" x 24"
R5LHC-4801	48" x 18"
R5LHE-4801	48" x 24"

Note Shelving must be ordered separately.



R5LEE-4803

9 drawers :
- 4-4" drawers
- 4-6" drawers
- 1-8" drawer

Product #	W x D
R5LEC-4803	36" x 18"
R5LEE-4803	36" x 24"
R5LGC-4803	42" x 18"
R5LGE-4803	42" x 24"
R5LHC-4803	48" x 18"
R5LHE-4803	48" x 24"

Note Shelving must be ordered separately.



R5LEE-4805

10 drawers :
- 6-4" drawers
- 4-6" drawers

Product #	W x D
R5LEC-4805	36" x 18"
R5LEE-4805	36" x 24"
R5LGC-4805	42" x 18"
R5LGE-4805	42" x 24"
R5LHC-4805	48" x 18"
R5LHE-4805	48" x 24"

Note Shelving must be ordered separately.



R5LEE-4807

11 drawers :
- 4-3" drawers
- 3-4" drawers
- 4-6" drawers

Product #	W x D
R5LEC-4807	36" x 18"
R5LEE-4807	36" x 24"
R5LGC-4807	42" x 18"
R5LGE-4807	42" x 24"
R5LHC-4807	48" x 18"
R5LHE-4807	48" x 24"

Note Shelving must be ordered separately.



R5LEE-4809

7 drawers and 1 front access roll-out shelf :
- 2-3" drawers
- 3-4" drawers
- 2-6" drawers

Product #	W x D
R5LEC-4809	36" x 18"
R5LEE-4809	36" x 24"
R5LGC-4809	42" x 18"
R5LGE-4809	42" x 24"
R5LHC-4809	48" x 18"
R5LHE-4809	48" x 24"

Note Shelving must be ordered separately.

Components

Drawers, Roll-out Shelves and Locking or Security Mechanisms

DRAWER IN SHELVING

Heavy-Duty Modular Drawer for Shelving

RF32



400 lb capacity, 100% extension;
 Heavy-duty construction;
 Easy to install;
 Vast choice of accessories offered to adapt to your storage needs;
 Available drawer heights : 3", 4", 5", 6", 7", 8", 9", 10", 12" and 14";
 Order by adding the height of the drawer to the number. Ex. : RF32-362406;
 For modular drawers with layouts,

SEE PAGES 151-155

SEE PAGES 137-150

Product #	W x D
RF32-3618	36" x 18"
RF32-3624	36" x 24"
RF32-4218	42" x 18"
RF32-4224	42" x 24"
RF32-4818	48" x 18"
RF32-4824	48" x 24"

Lock-Out Mechanism

RF85

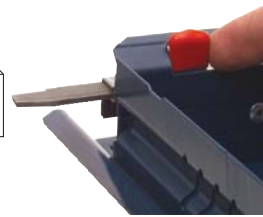

For both drawers and roll-out shelves;
 Locks drawers and roll-out shelves in open position;
 Activated manually, only when required;
 No interference with drawer accessories.

Product #
 RF85

Drawer Lock



L3

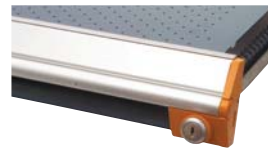

Compatible with all drawer dimensions;
 Does not affect usable drawer space;
 Easy to retrofit;
 Order by adding L3 to drawer or partitioning model number.
 Ex. : RF31-362406L3.

Product #
 L3



SEE PAGE 188

Heavy-Duty Front Access Roll-Out Shelf

RF41



400 lb capacity, 100% extension;
 Heavy-duty construction;
 Easy to install;
 Painted steel with 3" edges on back and sides;
 Height : 6";
 Full access to contents.

Product #	W x D
RF41-3618	36" x 18"
RF41-3624	36" x 24"
RF41-4218	42" x 18"
RF41-4224	42" x 24"
RF41-4818	48" x 18"
RF41-4824	48" x 24"

Security Panel

RF91

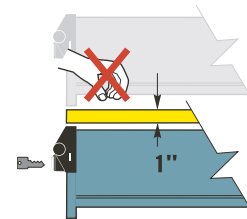

Compatible with drawer locks;
 Blocks access between two drawers;
 Usable space in the bank of drawers is reduced by 1";
 Installed between two drawers.

Product #	W x D
RF91-3618	36" x 18"
RF91-3624	36" x 24"
RF91-4218	42" x 18"
RF91-4224	42" x 24"
RF91-4818	48" x 18"
RF91-4824	48" x 24"

Heavy-Duty 3-Sided Access Roll-Out Shelf

RF45



400 lb capacity, 100% extension;
 Heavy-duty construction;
 Easy to install;
 Galvanized steel with 1 1/2" edge on back;
 Height : 5";
 Full access to contents.

Product #	W x D
RF45-3618	36" x 18"
RF45-3624	36" x 24"
RF45-4218	42" x 18"
RF45-4224	42" x 24"
RF45-4818	48" x 18"
RF45-4824	48" x 24"



Mounting Brackets

Standard Mounting Brackets

RE00

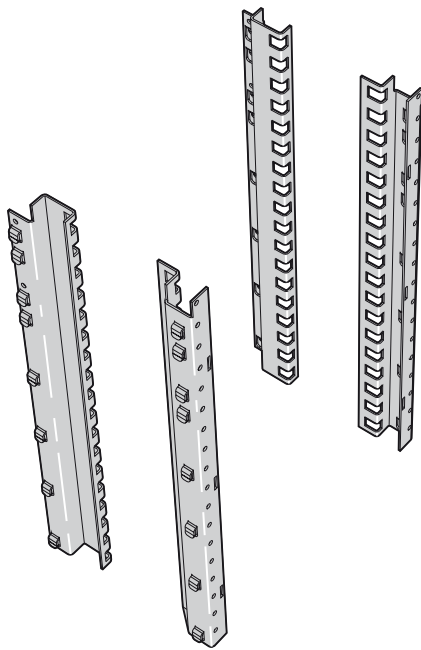

Rousseau modular drawers are adaptable to more than 35 brands of shelving available on the market.

COMPATIBLE UPRIGHT EXAMPLES

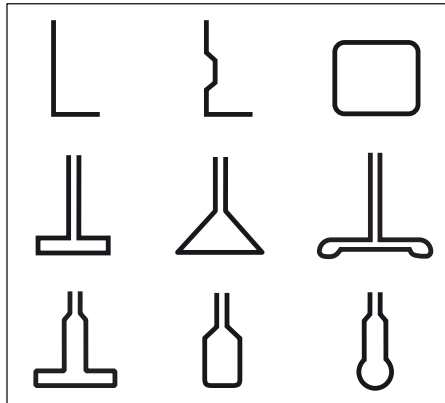

Easy hook-on assembly for most brands of shelving;
Standard heights : 18", 24", 36" and 48";

The mounting bracket kit is compatible with all drawer widths for Rousseau shelving (36", 42" and 48");

Each kit includes 2 front and 2 rear mounting brackets and all necessary hardware;

Holes at every 1" c/c for drawer adjustment;

Two mounting bracket sets may be stacked simply by installing a shelf between them. The total height of the drawers should not exceed 60". Ex. : 36" + 18" = 54" is safe;

SEE PAGE 85

To order mounting brackets of non-standard heights, contact our customer service.

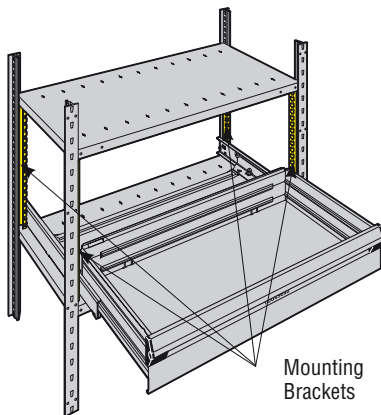

Mounting Brackets

Product #	Height
RE_-18	18"
RE_-24	24"
RE_-36	36"
RE_-48	48"

CODES FOR BRANDS OF SHELVING

Company	Brand	Code
Adapto	Vector	RE45
Aurora	Quik-Lok	RE04
Bilt Industries	Klip-Bilt II	RE18
Borroughs	Steel Shelving	RE02
Easyup	7000	RE31
Equipto	V-Grip	RE29
EZ Rect	Type I	RE14
EZ Rect	Trime Line	RE26
Hallowell	Hi-Tech Shelving	RE07
Inca	Inca-matic	RE10
Lyon	8000	RE16
Metalware	Interlok	RE05
Penco	Clipper	RE08
Penco	Erectomatic	RE07
Republic	Clip Shelving	RE20
Rousseau	"0"	RE01
Rousseau	Spider®	RE30
Spacesaver	4-post Shelving	RE04
Tennsco	L&T Shelving	RE04
Tennsco	Q-Line	RE43
Tri-Boro	Steel Shelving	RE33
Triple A	600	RE27
Western Pacific	Clip Shelving	RE22
Western Pacific	Deluxe	RE24

Other mounting brackets are available. If your brand of shelving is not listed here, contact our customer service.

Brands indicated are the property of their respective owners.

ATTENTION

To order, complete the product number with the code for your brand of shelving.

Example : **RE 30 - 48** for Rousseau Spider® shelving.

Custom-Order Mounting Brackets

Rousseau can manufacture mounting brackets for new brands of shelving. Contact our customer service for more information.

Accessories

DRAWER IN SHELVING

Vertical Security Bar



Locks a bank of drawers in shelving with either a key or a padlock;

To receive a safety hasp instead of a standard lock, order RE80-XXLPA instead of RE80-XXL3A;

Safety hasp for padlock is located at the top of the bar to facilitate access;

Covers a bank of drawers from 18" to 48" high;

Easy hook-on assembly;

Possible to install more than one bar on the same bracket for different users;

Installs on the right side;

36" high bar is compatible with 34" high mounting brackets and 48" high bar is compatible with 46" high mounting brackets;

Order by completing the product number with the type of key;

Offered for Rousseau Spider® shelving. For Spacesaver shelving, order RE81-XXXXA instead of RE80-XXXXA.



Product #	Height
RE80-18L3A	18"
RE80-24L3A	24"
RE80-30L3A	30"
RE80-36L3A	36"
RE80-48L3A	48"

RE80 Filler

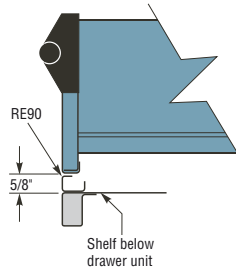

RE90

Installs with an adhesive strip under the bank of drawers;

Meets aesthetic requirements of certain work environments (hospitals, offices, etc.);

Offered for Rousseau Spider® and Spacesaver shelving only;

For Spacesaver shelving, order RE90-XX02 instead of RE90-XX01.

Product #	W x H
RE90-3601	36" x 5/8"
RE90-4201	42" x 5/8"
RE90-4801	48" x 5/8"

NOTE

Other accessories for Spider® shelving are available in the Spider® Shelving System section.

SEE PAGES 63-68

NOTE

To lock drawers in all other brands of shelving, see drawer lock (L3).

SEE PAGE 82

Some Accomplishments



Assembly and Security Recommendations

Stacking Brackets

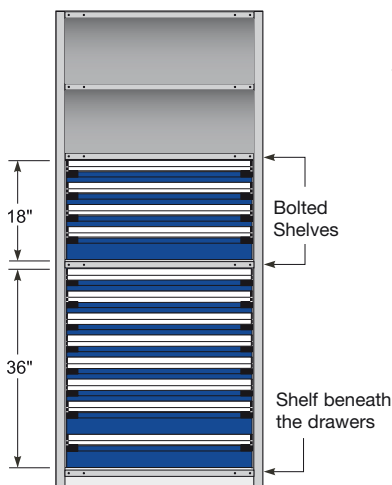

Two sets of mounting brackets can be stacked if a shelf is bolted between the two sections of drawers.
Example : 36" + 18".



R5XEE-2008

IMPORTANT



The height of the top drawer must not exceed 60", unless you have the proper equipment to reach drawers higher than 60" in a safe manner.

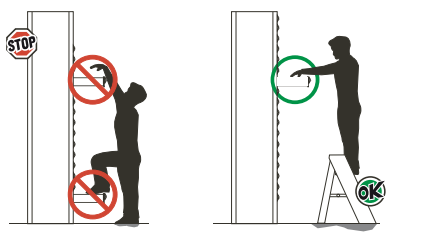

Assembly

Assemble using simple tools in three easy steps :

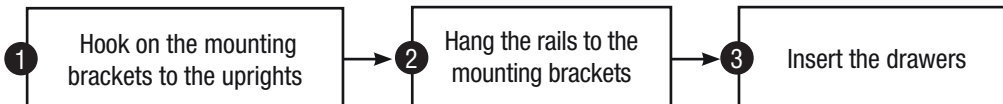

The minimum space required for drawers depends on the height of the mounting brackets.

Make sure that the shelving structure has been installed in compliance with manufacturer recommendations.

Anchoring shelving (particularly single rows) to the floor is mandatory.

To anchor Spider® shelving units,

SEE PAGE 70

To the floor or wall

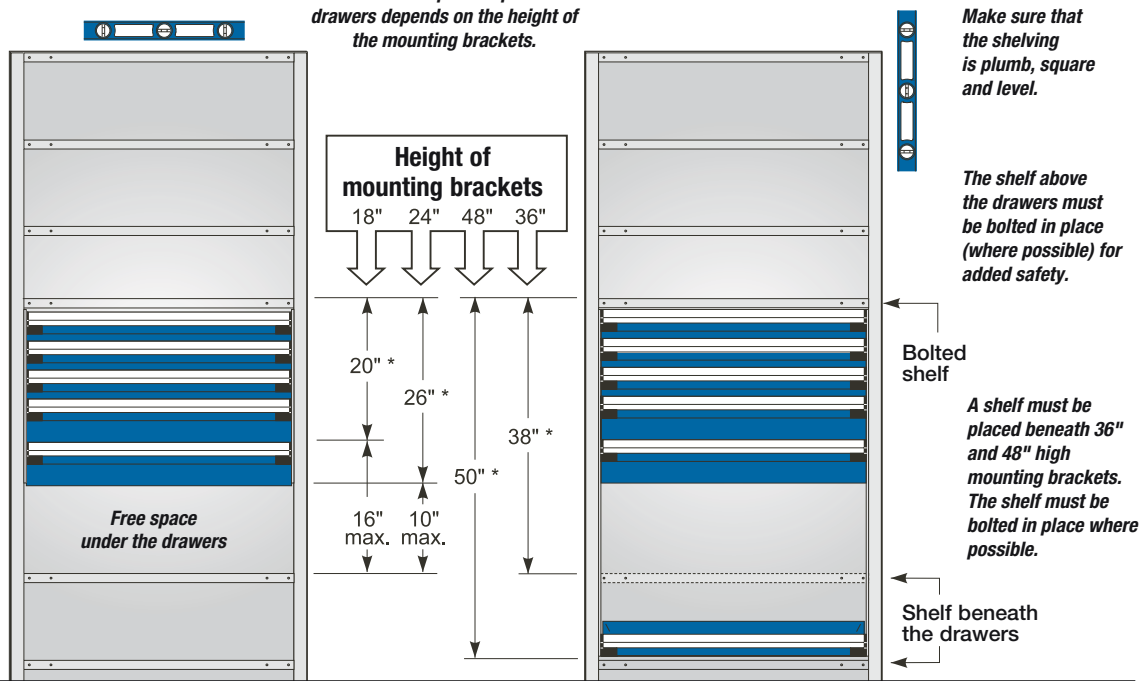

* Subtract 1/2" for shelving with 1 1/2" adjustable shelves (c/c).

Work Center

WORK CENTER



WORK CENTER

The Rousseau work center system offers a multitude of possible layouts, thanks to its numerous accessories which allow you to create a work center that responds to your exact needs.



LC3002C

Whether you are installing a workbench for a production or assembly line, or a custom layout for your machine tool workshop, our line of products offers you an impressive selection of accessories that are sure to meet and surpass your expectations. Whether you are looking for a basic workbench with two legs and a top, or a specialized table, stationary or mobile, you will find a solution for each and every application. From shipping and receiving, to your foreman's office, the quality and variety of our product will more than satisfy you.

Moreover, the Rousseau multi-purpose stand presents an immense advantage by being so easy to reconfigure, without tools. It can be changed according to your evolving needs by simply adding accessories.

Rousseau offers you several work surface dimensions for each of the surfaces offered: painted steel, stainless steel, laminated wood, laminated Acrylic/PVC, laminated and dissipative plastic tops. Rousseau, the one-stop solution to simplify your life!

The Rousseau Advantages

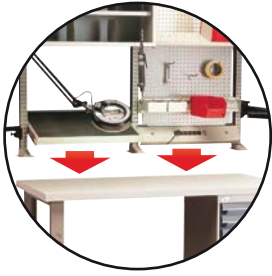

Rousseau will meet even your most specific workbench need, from top to bottom.



Re-configuring your workbench is easy and can be done without tools. This means your system will evolve with you and your needs.



Our impressive array of standard accessories allows you to build a custom bench.

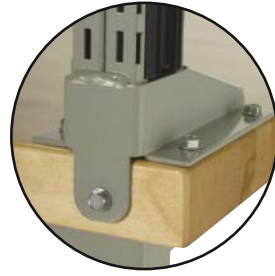

The WM structure can be installed on most industrial workbenches on the market. The six fixing zones mean limited interference and endless possibilities.

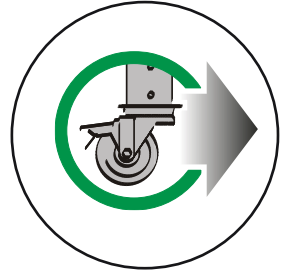

Many of our workbenches can be made mobile in order to better meet your needs.

General Dimensions

Components and accessories are divided into 3 groups and correspond to the principle workstation zones.

Popular sizes indicated in red

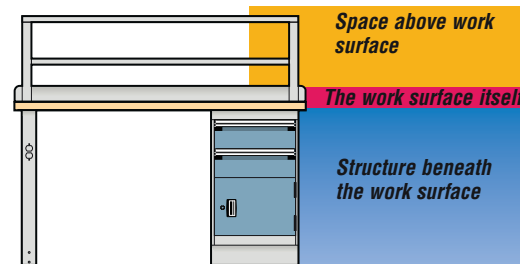
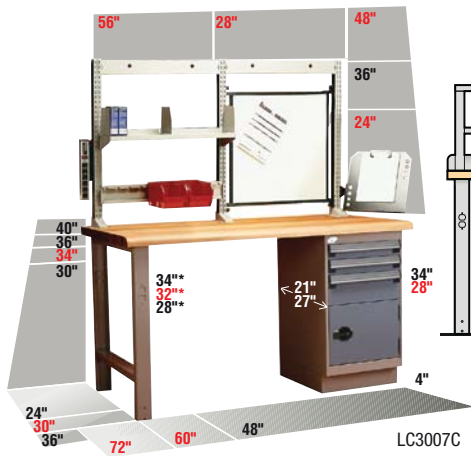

*Extensions offered for other heights

SEE PAGE 98

Index	Page(s)
Work Center	86 - 87
Proposals	88 - 95
Components	
- work surface	96 - 97
- structure under the work surface	98 - 109
- structure above the work surface	110 - 122
- specialized structure for technician	123-124
Specialized Work Center Proposals	125
Multi-Purpose Stand	126
Proposals	127 - 128
Components	129
Ergonomic Seats	130 - 131

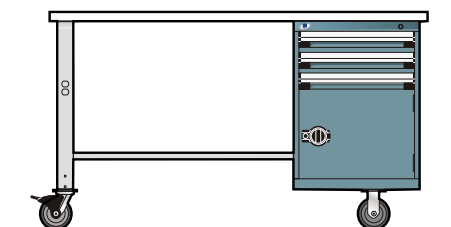
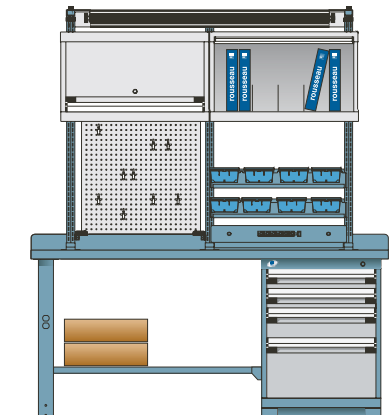
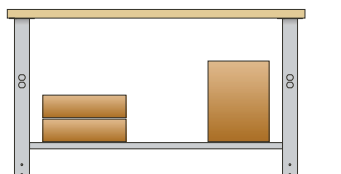
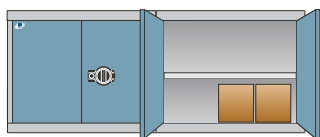

Proposals

Basic Workbenches

Basic Workbench with Stringer



WSA2031

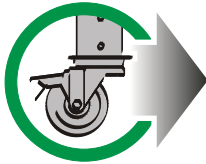

This table can be made mobile.

Dimensions			Type of Top			
W	D	H	Steel	Lam. wood	Plastic lam.	Acrylic/PVC
60"	30"	34"	WS_1031	WS_2031	WS_3031	WS_9031
72"	30"	34"	WS_1035	WS_2035	WS_3035	WS_9035
72"	36"	34"	WS_1039	WS_2039	WS_3039	WS_9039

NOTE

To order, complete the part number according to the following:

A for a stationary table;
W for a mobile table.

Example: **WSW2031**

- 1 top of your choice;
- 2-27" D x 32" H legs;
- 1 stringer.

Mobile model (total height 35") includes the following additional accessories:

- 2 pairs of caster adaptors for legs;
- 1 pair of 4" rigid casters;
- 1 pair of 4" swivel casters with total-lock brake;
- 1 footrest;

Note: Leg height on mobile models is 28".

Workbench with Shelf



WSA2019

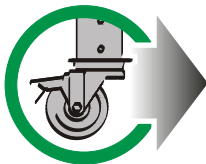

This table can be made mobile.

Dimensions			Type of Top			
W	D	H	Steel	Lam. wood	Plastic lam.	Acrylic/PVC
60"	30"	34"	WS_1019	WS_2019	WS_3019	WS_9019
72"	30"	34"	WS_1023	WS_2023	WS_3023	WS_9023
72"	36"	34"	WS_1027	WS_2027	WS_3027	WS_9027

NOTE

To order, complete the part number according to the following:

A for a stationary table;
W for a mobile table.

Example: **WSW2019**

- 1 top of your choice;
- 2-27" D x 32" H legs;
- 2 shelves, each 12" D;
- 1 stringer.

Mobile model (total height 35") includes the following additional accessories:

- 2 pairs of caster adaptors for legs;
- 1 pair of 4" rigid casters;
- 1 pair of 4" swivel casters with total-lock brake;

Note: Leg height on mobile models is 28".

Closed Table



WSA2070

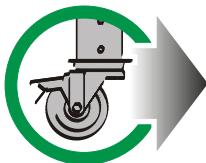

This table can be made mobile.

Dimensions			Type of Top			
W	D	H	Steel	Lam. wood	Plastic lam.	Acrylic/PVC
60"	30"	34"	WS_1070	WS_2070	WS_3070	WS_9070
72"	30"	34"	WS_1071	WS_2071	WS_3071	WS_9071
72"	36"	34"	WS_1072	WS_2072	WS_3072	WS_9072

NOTE

To order, complete the part number according to the following:

A for a stationary table;
W for a mobile table.

Example: **WSW2070**

- 1 top of your choice;
- 2-27" D x 32" H legs;
- 1 sliding doors with L3 lock;
- 2 side panels and 1 back panel;
- 3 shelves, each 12" D;
- 2 leg crossbars.

Mobile model (total height 35") includes the following additional accessories:

- 2 pairs of caster adaptors for legs;
- 1 pair of 4" rigid casters;
- 1 pair of 4" swivel casters with total-lock brake;

Note: Leg height on mobile models is 28".

Desk with Closed Legs



WSA3043

Dimensions			Type of Top			
W	D	H	Steel	Lam. wood	Plastic lam.	Acrylic/PVC
60"	30"	30"	WSA1043	WSA2043	WSA3043	WSA9043
72"	30"	30"	WSA1044	WSA2044	WSA3044	WSA9044

NOTE These models cannot be used in mobile applications.

- 1 top of your choice; _____
- 1 back panel; _____
- 2-27" D x 28" H closed legs; _____
- 1 shelf, 12" D. _____

Closed Desk with Closed Legs



WSA3170

Dimensions			Type of Top			
W	D	H	Steel	Lam. wood	Plastic lam.	Acrylic/PVC
60"	30"	34"	WSA1170	WSA2170	WSA3170	WSA9170
72"	30"	34"	WSA1171	WSA2171	WSA3171	WSA9171
72"	36"	34"	WSA1172	WSA2172	WSA3172	WSA9172

NOTE These models cannot be used in mobile applications.

- 1 top of your choice; _____
- 1 back panel; _____
- 2-27" D x 32" H legs; _____
- 3 shelf, each 12" D; _____
- 2 legs crossbars; _____
- 1 front finishing panel; _____
- 1 back finishing panel; _____
- 1 sliding door with L3 lock. _____

Open Double Workbench



WSA2902

Dimensions				Type of Top			
W	D	H	H	Steel	Lam. wood	Plastic lam.	Acrylic/PVC
8'	(2 x 48")	30"	34"	WSA1902	WSA2902	WSA3902	WSA9902
10'	(2 x 60")	30"	34"	WSA1904	WSA2904	WSA3904	WSA9904
12'	(2 x 72")	30"	34"	WSA1906	WSA2906	WSA3906	WSA9906

NOTE These models cannot be used in mobile applications.

- 2 tops of your choice; _____
- 3-27" D x 32" H legs; _____
- 2 stringers; _____
- 4 steel shelves, each 12" D; _____
- 1 shelf adaptor for common leg; _____
- 1 stringer extension for common leg. _____

Closed Double Workbench



WSA2971

Dimensions				Type of Top			
W	D	H	H	Steel	Lam. wood	Plastic lam.	Acrylic/PVC
8'	(2 x 48")	30"	34"	WSA1971	WSA2971	WSA3971	WSA9971
10'	(2 x 60")	30"	34"	WSA1973	WSA2973	WSA3973	WSA9973
12'	(2 x 72")	30"	34"	WSA1975	WSA2975	WSA3975	WSA9975

NOTE These models cannot be used in mobile applications.

- 2 tops of your choice; _____
- 3-27" D x 32" H legs; _____
- 2 side panels and 2 back panels; _____
- 4 steel shelves, each 12" D; _____
- 1 shelf adaptor for common leg; _____
- 2 sets of sliding doors with L3 lock; _____
- 2 side extensions for common leg. _____

Workbench with Cabinet



LG2101C

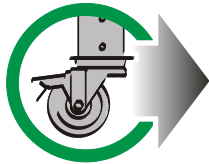

This table can be made mobile.



27" deep cabinets are recommended for mobile workstations or workstations with multi-purpose frames.

Dimensions			Type of Top			
W	D	H	Steel	Lam. wood	Plastic lam.	Acrylic/PVC
60"	30"	34"	L_1101C	L_2101C	L_3101C	L_9101C
72"	30"	34"	L_1102C	L_2102C	L_3102C	L_9102C
72"	36"	34"	LH1103C	LH2103C	LH3103C	LH9103C

NOTE

To order, complete part number according to the following:

- G** for a stationary bench with 21" deep cabinet (for 30" D benches only);
- H** for a stationary bench with 27" deep cabinet (for 30" D and 36" D benches only);
- J** for a mobile bench.

- | | |
|-------------------------------------|--|
| 1 top of your choice; | Mobile model (total height 35") includes the following additional accessories: |
| 1-27" D x 32" H leg; | 1 base for casters for compact cabinet; |
| 1 "L" compact cabinet with 4" base; | 1 pair of caster adaptors for leg; |
| 1 pair of cabinet attachment bars. | 1 pair of 4" rigid casters; |
| | 1 pair of 4" swivel casters with total-lock brake; |
| | 1 footrest. |

Note Cabinet base not included with mobile model.

Workbench with Two Cabinets



LG2201C



27" deep cabinets are recommended for mobile workstations or workstations with multi-purpose frames.

Dimensions			Type of Top			
W	D	H	Steel	Lam. wood	Plastic lam.	Acrylic/PVC
60"	30"	34"	L_1201C	L_2201C	L_3201C	L_9201C
72"	30"	34"	L_1202C	L_2202C	L_3202C	L_9202C
72"	36"	34"	LH1203C	LH2203C	LH3203C	LH9203C

NOTE

To order, complete part number according to the following:

- G** for a stationary bench with 21" deep cabinet (for 30" D benches only);
- H** for a stationary bench with 27" deep cabinet (for 30" D and 36" D benches only);

NOTE

These models cannot be used in mobile applications.

- 1 top of your choice;
- 2 "L" compact cabinets with 4" bases;
- 2 pairs of cabinet attachment bars.

Workbench with Suspended Cabinet



LG2001

NOTE

Maximum capacity of 50 lbs per drawer in a suspend cabinet application using RA70.

Dimensions			Type of Top			
W	D	H	Steel	Lam. wood	Plastic lam.	Acrylic/PVC
60"	30"	34"	LG1001	LG2001	LG3001	LG9001
72"	30"	34"	LG1002	LG2002	LG3002	LG9002
72"	36"	34"	LH1003	LH2003	LH3003	LH9003

NOTE

These models cannot be used in mobile applications.

- | | |
|-----------------------|------------------------------------|
| 1 top of your choice; | 1-21" deep "L" compact cabinet; |
| 2-27" D x 32" H legs; | 1 pair of cabinet attachment bars. |
| 1 stringer; | |

Desk with Cabinet



LG3107



27" deep cabinets are recommended for workstations with multi-purpose frames.

Dimensions			Type of Top		
W	D	H	Steel	Lam. wood	Plastic lam.
60"	30"	34"	LG1107	LG2107	LG3107
72"	30"	34"	LG1108	LG2108	LG3108
72"	36"	34"	LH1109	LH2109	LH3109

1 top of your choice;

1-27" D x 28" H closed leg;

1 "L" compact cabinet of 21" D;

1 pair of cabinet attachment bars.

NOTE These models cannot be used in mobile applications.

Workbench with Heavy-Duty Cabinets



R5WH5-2007

1 laminated wood top WS14-6030A

1-27" D x 32" H leg WS20-2732

1 heavy-duty cabinet with partitioning R5ACG-3013

Product # **W x D x H**

R5WH5-2007 60" x 30" x 34"

NOTE These model cannot be used in mobile applications.



R5WL5-2001

1 laminated wood top WS14-7230A

1 heavy-duty cabinet with partitioning R5ACG-3013

1 heavy-duty cabinet with partitioning R5ACG-3015

Product # **W x D x H**

R5WL5-2001 72" x 30" x 34"

NOTE These model cannot be used in mobile applications.



R5WH4-2001

1 laminated wood top WS14-6027A

1 heavy-duty cabinet with partitioning R5ACG-3013

1 heavy-duty cabinet with partitioning R5ADG-5827

1 side bracket for top RA73-02

Product # **W x D x H**

R5WH4-2001 90" x 27" x 60"

NOTE These model cannot be used in mobile applications.

Proposals

WORK CENTER

Basic Electronic Workbench



WSA4073

Dimensions			Type of Top		
W	D	H	Laminated wood	Plastic laminate	Dissipative*
60"	30"	34"	WSA2073	WSA3073	WSA4073*
72"	30"	34"	WSA2074	WSA3074	WSA4074*
72"	36"	34"	WSA2075	WSA3075	WSA4075*

- 1 top of your choice;
- 2-27" D x 32" H legs;
- 1 back stop;
- 1 stringer;
- 1 pair of risers with electrical outlets on both sides;
- 1-12" D shelf, same material as top;
- 1 shelf back.

NOTE *Models with dissipative tops come with:
1 grounding block;
1 grounding cord and 1 ground wrist strap.

SEE PAGE 112

Electronic Workbench with Cabinet



LG4104C

Dimensions			Type of Top		
W	D	H	Laminated wood	Plastic laminate	Dissipative*
60"	30"	34"	LG2104C	LG3104C	LG4104C*
72"	30"	34"	LG2105C	LG3105C	LG4105C*
72"	36"	34"	LH2106C	LH3106C	LH4106C*

- 1 top of your choice;
- 1-27" D x 32" H leg;
- 1 "L" compact cabinet with 4" base;
- 1 back stop;
- 1 pair of risers with electric outlets on both sides;
- 1-12" D shelf, same material as top;
- 1 shelf back;
- 1 pair of cabinet attachment bars..

NOTE *Models with dissipative tops come with:
1 grounding block;
1 grounding cord and 1 ground wrist strap.

SEE PAGE 112

Adjustable Workbench



WSA3050

Dimensions			Type of Top			
W	D	H	Steel	Lam. wood	Plastic lam.*	Dissipative**
60"	30"	30" to 42"	WSA1050	WSA2050	WSA3050*	WSA4050**
72"	30"	30" to 42"	WSA1051	WSA2051	WSA3051*	WSA4051**
72"	36"	30" to 42"	WSA1052	WSA2052	WSA3052*	WSA4052**

- * 725 lb capacity.
- 1 top of your choice;
- 2-27" D x 27" H open legs for lift system;
- 1 hydraulic lifting system;
- Anti-skid leveling glides;
- 12" vertical adjustment (30" - 42");
- 1-17" high stringer;
- Compatible with WM accessories;
- System capacity: 825 lb.

NOTE These models cannot be used in mobile applications.

NOTE **Models with dissipative tops come with:
1 grounding block;
1 grounding cord and 1 ground wrist strap.

SEE PAGE 112

Wall-Mounted Workbench with Wall Cabinet



R5WH5-2010

Dimensions		Type of Top		
W	D	Steel	Laminated wood	Plastic laminate
60"	30"	R5WH5-1010	R5WH5-2010	R5WH5-3010

- 1 top of your choice;
- 2 legs
- 2 leg crossbars
- 1 shelf
- 2 wall cabinets
- WS50-6012
- R5MDA3003

NOTE Leg height is 28" and top thickness is 1 3/4".

Workstations – Tables and Multi-Purpose Frames

Basic Workstation

WSC0133

Better organization with the help of Rousseau accessories.



WSC0133

1 WM single unit frame	WM11-2848
2 tilttable shelves	WM20-2812
2 plastic bin rails	WM28-2801
1 vertical adaptor for electrical and air outlets	WM41-01
1 power outlet strip	70000505
6 partial dividers	SH52-1206
5 plastic bins	RG20-040303
2 open legs	WS20-2732
1 stringer	WS22-6005
1 painted steel top	WS10-6030

Product #	W x D x H
WSC0133	60" x 30" x 80"

Packaging Station

WSM0006

All the right accessories for a packaging station, with a spool support under the table.



WSM0006

2 multi-purpose uprights	WM10-48
2 steel shelves	WS50-6012
2 structural shelf supports	WM27-1201
6 sliding dividers	WS87-1210
1 vertical adaptor for electrical and air outlets	WM41-01
1 power strip	70000505
1 document holder with arm	WM70-01
2 open legs	WS20-2732
1 stringer	WS22-6005
1 laminated wood top	WS14-6030A

1 paper and cardboard spool support	WS86-60
2 leg crossbars	WS24-27

Product #	W x D x H
WSM0006	60" x 30" x 80"

SOLD SEPARATELY

Packaging shear cutter WM87-01



SEE PAGE 100

End-of-Aisle Workstation

WSM0017

Perfect for consulting information close to stored materials.



WSM0017

2 closed legs	WS25-2732
1 laminated wood top	WS14-3630A
1 WS90-01 sliding keyboard tray or WS90-02 adjustable keyboard tray (except on WSM0018 model without keyboard tray)	
1 single unit frame	WM11-2848
2 tilttable shelves	WM20-2812
6 partial dividers	SH52-1206
1 power strip	70000505
1 vertical adaptor for electrical and outlets	WM41-01
1 document holder with arm	WM70-01
1 tackboard / marker panel	WM54-2424
1 panel bracket kit	WM50-01

Product #	Type of Keyboard Tray	W x D x H
WSM0016	WS90-01 sliding tray	36" x 30" x 80"
WSM0017	WS90-02 adjustable tray	36" x 30" x 80"
WSM0018	Model without tray	36" x 30" x 80"

SOLD SEPARATELY

Footrest WS27-2012



SEE PAGE 99

IMPORTANT An ergonomic chair and footrest are recommended for this type of workstation.

Proposals

WORK CENTER

Electronic Workstation

LC3002C



LC3002C

Protects sensitive electronic equipment.

1 WM unit frame	WM11-5648
1 tiltable shelf	WM20-2812
2 plastic bin rails	WM28-2801
1 power outlet channel	WM40-2801
1 monitor tray with arm	WM62-01A
1 tiltable pan	WM22-2820
1 storage cabinet with door	WM75-251516L3
1 pair of cantilever overhead supports	WM18-26
1 overhead workstation light	WM45-48T8
7 partial dividers (4 inside storage cabinet)	SH52-1206

5 plastic bins	RG20-040303
1 shelf for storage cabinet	WM20-2812
1 fluorescent work lamp with magnifier	70000635
1 adaptor for lamp or light-duty arm	WM68-01
1 open leg	WS20-2732
1 light-duty cabinet	WS30-2459
1 compact cabinet «L» with 4" base	L3ABD-2808C
1 pair of cabinet attachment bars	RA70-21
1 dissipative top	WS17-6030A
1 grounding block	70000350
1 ground wrist strap	70000320

Product #	W x D x H
LC3002C	60" x 30" x 80"

Quality Control Workstation

LC3003C



LC3003C

Our proposal to enhance quality control and inspection tasks.

1 single WM unit frame	WM11-2848
1 tiltable shelf	WM20-2812
1 overhead workstation light	WM45-48T8
1 pair of cantilever overhead supports	WM18-26
1 power outlet channel	WM40-2801
1 monitor tray with arm	WM62-01A
1 keyboard and mouse tray	WM63-2402
1 tackboard / marker panel	WM54-2424
1 panel bracket kit	WM50-01

3 partial dividers	SH52-1206
1 open leg	WS20-2732
1 light-duty cabinet	WS30-2459
1 compact cabinet «L» with 4" base	L3ABD-2808C
1 pair of cabinet attachment bars	RA70-21
1 plastic laminate top	WS16-6030A

Product #	W x D x H
LC3003C	60" x 30" x 80"

Assembly Workstation

LC3001



LC3001

Designed to promote efficient assembly work.

1 double WM unit frame	WM11-5648
2 plastic bin rails	WM28-2801
1 vertical adaptor for electrical and air outlets	WM41-01
1 power outlet strip	70000505
1 document holder with arm	WM70-01
1 perforated panel	WM53-2436
2 panel bracket kits	WM50-01
1 tackboard / marker panel	WM54-2424
1 overhead workstation light	WM45-48T8
1 tool rail	WM47-6001
1 pair of cantilever overhead supports	WM18-26
1 balancer trolley	WM48-01

1 tool balancer	WM49-01
5 plastic bins	RG20-040303
1 pack of 10 double back single hooks	WM98-03
2 open legs	WS20-2732
1 drawer unit	LD75-182109
2 compact drawers of 3"	LF31-182103
1 plastic laminate top	WS16-6030A
1 stringer	WS22-6005

Product #	W x D x H
LC3001	60" x 30" x 80"

Basic Workstation with Cabinet

R5WH5-2005



R5WH5-2005

Both bulky and high density storage in one workstation.

1 heavy-duty cabinet with partitioning	R5ACG-3013
1 open leg	WS20-2732
1 laminated wood top	WS14-6030A
2 storage cabinets with double integrated doors	R5MDA-3003
2 WM brackets for storage cabinet	RD08-28
1 double WM unit frame	WM11-5648

Product #	W x D x H
R5WH5-2005	60" x 30" x 80"

Assembly Workstation with Cabinet

R5WH5-2003



R5WH5-2003

Access your parts and tools faster.

1 heavy-duty cabinet with partitioning	R5ACG-3013
1 laminated wood top	WS14-6030A
1 open leg	WS20-2732
1 double WM unit frame	WM11-5648
1 tiltable shelf	WM20-2812
2 partial dividers	SH52-1206
1 vertical adaptor for electrical and air outlets	WM41-01
1 power outlet strip	70000505
1 steel shelf	WS50-6012
1 pair of structural shelf supports	WM27-1201
1 privacy panel	WM52-2436
1 panel bracket kit	WM50-01
1 louvered panel	WM55-2836
2 plastic bins	RG20-060603
5 plastic bins	RG20-060602

Product #	W x D x H
R5WH5-2003	60" x 30" x 80"

Maintenance Workstation with Cabinets

R5WL5-2003



R5WL5-2003

Designed to centralize all of the materials needed for your activities.

1 heavy-duty cabinet with partitioning	R5ACG-3013	1 tool support	WM30-01
1 heavy-duty cabinet with partitioning	R5ACG-3015	4 plastic bins	RG20-060603
1 laminated wood top	WS14-7230A	1 power outlet channel	WM40-2801
2 steel shelves	WS50-2412	1 tiltable pan	WM22-2820
2 adaptors for WS50 shelf	RC15-24	2 tiltable shelves	WM20-2812
1 double WM unit frame	WM11-5648	4 partial dividers	SH52-1206
1 pair of cantilever overhead supports	WM18-26	2 storage cabinets with door	WM75-281516L3
1 overhead workstation light	WM45-48T8	1 document holder with arm	WM70-01
1 tool rail	WM47-6001	1 monitor tray with double arm	WM62-02A
1 balancer trolley	WM48-01	1 keyboard and mouse tray	WM63-2402
1 tool balancer	WM49-01		
2 plastic bin rails	WM28-2801		

Product #	W x D x H
R5WL5-2003	72" x 30" x 80"

Components - Work Surfaces

Work Surfaces

WORK CENTER

Painted Steel Top

WS10



Top for industrial, maintenance, repair or assembly applications;

Thickness: 1 3/4";

2 steel crossbars for attaching legs;

3 wood crossbars (2" x 4") for attaching cabinets and other accessories;

May be reinforced or soundproofed with a WS75 wood filler;

Excellent impact resistance;

Powder paint.

Stainless Steel Top

WS12



Top for industrial, maintenance, repair or assembly applications or when solvents, oils or other chemical products are being used;

Thickness: 1 3/4";

Brushed finish #4, attractive appearance;

2 steel crossbars for attaching legs;

3 wood crossbars (2" x 4") for attaching cabinets and other accessories;

May be reinforced or soundproofed by adding a WS75 wood filler;

Excellent corrosion resistance;

Excellent chemical resistance (can be in prolonged contact with a substance).

Laminated Wood Top

WS14



Top for general industrial applications;

Thickness: 1 3/4";

Made with varnished hardwood slats;

90° radius front edge for more comfort;

Good impact resistance;

Attractive appearance.

Resistant Acrylic/PVC Plastic Laminated Top

WS08



Ideal for assembly stations or for applications using solvents, oils or other chemical products;

Thickness: 1 1/2";

Color: Gray;

Core made of particle board;

Finish: sheet of gray polymer;

Deluxe quality laminated top;

Excellent chemical product resistance (can be in prolonged contact with a substance);

Superior abrasion resistance compared to standard laminated top;

Superior impact resistance compared to standard laminated top;

Attractive appearance.

Plastic Laminated Top

WS16



Top for general applications. Ideal for assembly, quality control and packaging applications;

Thickness: 1 1/2";

Color: White;

Attractive appearance;

Easy to clean;

90° radius front edge for more comfort.

Dissipative Top

WS17



Top for electronics applications. Ideal for assembly or electronics inspection stations;

Thickness: 1 1/2";

Color: White;

Attractive appearance;

Easy to clean;

90° radius front for more comfort;

Dissipates electric charges that can damage electronic components;

Resistance point to point and point to ground between 10⁶ and 10⁹ Ω.

NOTE Please refer to W54 tech sheet for capacity according to configuration. Available on Multi Tool CD.

Dimensions		Type of Top					
W	D	Acrylic/PVC plastic laminate	Painted steel	Stainless steel	Laminated wood	Plastic laminate	Dissipative
36"	24"				WS14-3624A	WS16-3624A*	
	30"				WS14-3630A*	WS16-3630A*	
48"	24"	WS08-4824A*	WS10-4824	WS12-4824 *	WS14-4824A*	WS16-4824A*	WS17-4824A*
	30"	WS08-4830A*	WS10-4830	WS12-4830 *	WS14-4830A*	WS16-4830A*	WS17-4830A*
	36"	WS08-4836A*	WS10-4836	WS12-4836 *	WS14-4836A*	WS16-4836A*	WS17-4836A*
60"	24"	WS08-6024A*	WS10-6024	WS12-6024 *	WS14-6024A*	WS16-6024A*	WS17-6024A*
	30"	WS08-6030A	WS10-6030	WS12-6030 *	WS14-6030A	WS16-6030A	WS17-6030A
	36"	WS08-6036A*	WS10-6036	WS12-6036 *	WS14-6036A*	WS16-6036A*	WS17-6036A*
72"	24"	WS08-7224A	WS10-7224	WS12-7224 *	WS14-7224A	WS16-7224A	WS17-7224A*
	30"	WS08-7230A	WS10-7230	WS12-7230 *	WS14-7230A	WS16-7230A	WS17-7230A
	36"	WS08-7236A	WS10-7236	WS12-7236 *	WS14-7236A	WS16-7236A	WS17-7236A

NOTE *Please check with your customer service representative for lead time.

Components - Work Surfaces

WORK CENTER

Steel Top Crossbar

WS11 / WS13

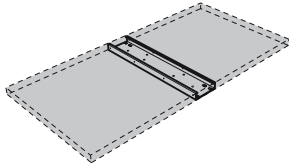

Painted steel: WS11;
Stainless steel: WS13;
May be attached to center of steel top (WS10 or WS12) for reinforcement;
To order, complete the part # with steel choice needed.

Product #	W x D
WS_-24	6" x 24"
WS_-30	6" x 30"
WS_-36	6" x 36"

Wood Filler for Steel Top

WS75

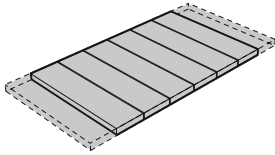

Made from wooden crossbars;
Inserted into WS10 and WS12 steel tops for soundproofing;
Increases solidity of steel tops;
Allows attachment of accessories beneath the work surface;
Depths available: 24", 30" and 36";
To order, complete the part # with depth wanted.

Product #	Width
WS75-48	48"
WS75-60	60"
WS75-72	72"

Wood Crossbar for Steel Top

WS76

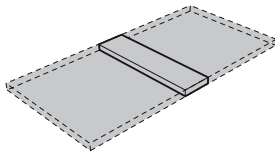

Allows attachment of cabinets, hanging cabinets and drawer units. Also used to secure back panels beneath the steel top;
Depths available: 24", 30" and 36";
To order, complete the part # with depth wanted;
Note: 3 crossbars (2" x 4") are included with each WS10 and WS12 steel top.

Product #	W x H
WS76-0202	2" x 2"
WS76-0204	4" x 2"
WS76-0208	8" x 2"



Laminated Wood Top

SR90

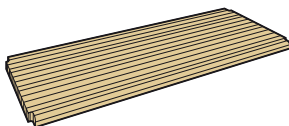

Designed to be installed between two shelving units;
A pair of SH74 top supports must be ordered for installation.

Product #	W x D
SR90-6024A	60" x 24"
SR90-7224A	72" x 24"

Back and Side Stops

WS18 / WS98

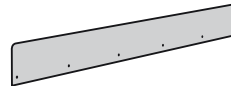

Painted steel: WS18;
Stainless steel: WS98;
Can be attached to back or sides according to top dimensions;
May be installed on all types of tops;
Height: 5". Clear top by approx. 3 1/4";
To order, complete the part # with steel choice needed.

Product #	Length
WS_-2405	24"
WS_-3005	30"
WS_-3605	36"
WS_-4805	48"
WS_-6005	60"
WS_-7205	72"

Sliding Keyboard Tray

WS90-01

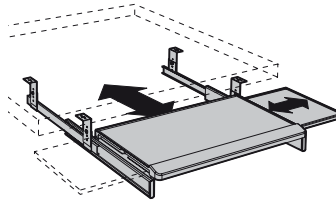

May be mounted on all surfaces;
Mouse tray slides to the left or right side, as needed;
Usable area: 8 1/2" x 20 1/2";
Mouse tray: 9 3/8" x 9 1/8".

Product #	Color
WS90-01	Black

Adjustable Keyboard Tray

WS90-02

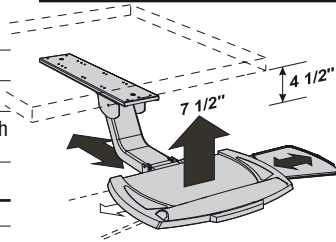

Support with articulating arm designed for use in the sit/stand position;
May be mounted on all surfaces;
Includes:
- mouse tray, slides to the left or right side, as needed
- ergonomic palm rest

Slides under the work surface for storage. Sturdy construction;
Usable area: 9 1/2" x 20 1/2";
Mouse tray: 9 3/8" x 9".

Product #	Color
WS90-02	Black

CPU Support

WS92



May be mounted on all surfaces;
Handle allows width of plastic side support to be adjusted;
Adjustments accommodate computers with dimensions of 3 1/2" to 9 1/4" width by 12 1/2" to 22 1/2" height;
Width: 8 3/8" to 11 1/2";
Depth: 6 3/4" (8 1/2" with handle);
Height: 18" to 26".

Product #	Color
WS92-01	Black

Top Supports

SH74

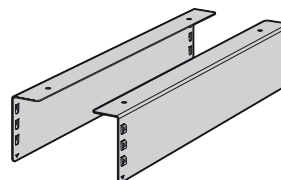

Sold in pairs;
Designed to support a SR90 laminated wood top between two shelving units;
Easy hook assembly.

Product #	Depth
SH74-24	24"

Components - Structure Under the Work Surface

Structural Components

WORK CENTER

Open Leg

WS20

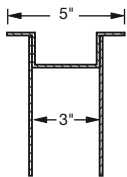
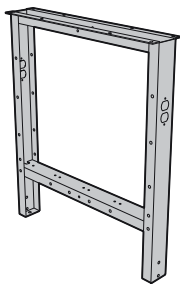

Three basic heights: 28", 32" and 34";
 WS21 leg extensions can be added according to need;
 "Inversed" hat shaped top for added strength;
 Equipped with knockouts to allow installation of electrical outlets;
 A second leg crossbar, WS24, can be added to permit installation of WS50 shelves;
 Can be closed with a WS62 side panel.

Product #	D x H	Surface Depth
WS20-2128	21" x 28"	24" and 30"
WS20-2132	21" x 32"	24" and 30"
WS20-2134	21" x 34"	24" and 30"
WS20-2728	27" x 28"	30" and 36"
WS20-2732	27" x 32"	30" and 36"
WS20-2734	27" x 34"	30" and 36"

Closed Leg

WS25

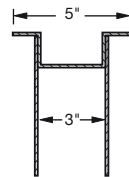
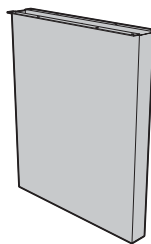

For office applications where appearance is important;
 Three basic heights: 28", 32" and 34";
 "Inversed hat" shaped top for added strength;
 One closed side. The face and exterior side have no holes; accessory fixing zones on inner face;
 A second leg crossbar, WS24, may be added to permit installation of WS50 shelves.

Product #	D x H	Surface Depth
WS25-2128	21" x 28"	24" and 30"
WS25-2132	21" x 32"	24" and 30"
WS25-2134	21" x 34"	24" and 30"
WS25-2728	27" x 28"	30" and 36"
WS25-2732	27" x 32"	30" and 36"
WS25-2734	27" x 34"	30" and 36"

Leg Extensions / Caster Adaptors

WS21

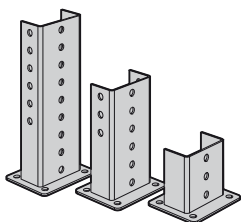

For open legs only;
 Sold in pairs;
 Three heights: 3", 6" and 9";
 The 6" and 9" extensions adjust leg height;
 Casters may be installed with 3" and 6" extensions; the 9" extensions must not be used with casters.

Product #	Height	Possible Adjustment*	Type of Caster
WS21-0306	3"	—	4" or 6"
WS21-0606	6"	To 3"	4" or 6"
WS21-0904	9"	To 6"	Not compatible

*See W55 tech sheet for details. Available on Multi Tool CD.

Leg Crossbar

WS24

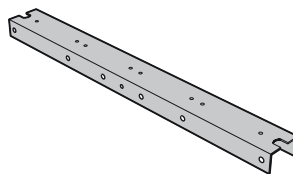

Allows addition of a second shelf level beneath the work surface;
 May be affixed to a WS20 open leg or WS25 closed leg.

Product #	Leg Depth
WS24-21	21"
WS24-27	27"

Open Wall-Mounted Leg

WS95

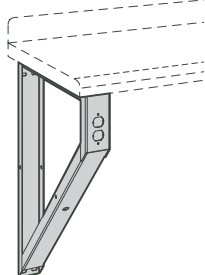

500 lb capacity per leg; 1000 lb capacity per pair (assuming that wall and wall anchoring are sufficient);
 Anchoring hardware not provided by Rousseau;
 Designed for 24", 30" and 36" deep tops;
 Compatible with all types of tops offered by Rousseau;
 Compatible with WS18 back stop and WM10 & WM11 multi-purpose uprights;
 Equipped with electrical outlet knockouts on front of leg;
 Possible to install WS96 crossbars and 12" deep WS50 shelf (available as an option).

Product #	D x H
WS95-2428	22 5/8" x 29 7/16"



R5WH5-2101

Crossbar for Wall Leg

WS96

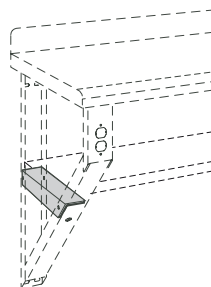

Installation of 12" deep WS50 shelf is possible (available as an option);
 Use with WS95 wall-mounted leg.

Product #	Depth
WS96-24	13 3/4"

Components - Structure Under the Work Surface

Stringer

WS22

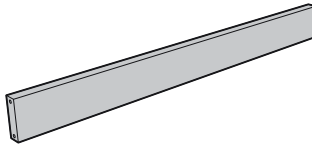

Attaches between the two legs at the rear, to strengthen structure;
Standard widths that fit top surface widths;
May serve as a back for shelves beneath work surface.

Product #	Width	Surface Width
WS22-4805	39"	48"
WS22-6005	51"	60"
WS22-7205	63"	72"

Adjustable Footrest

WS23

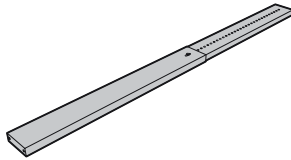

Adjustable width; can be extended by sliding the two parts;
Required for all mobile workstations;
May be attached to leg crossbars or on the sides of cabinets to strengthen structure.

Product #	Width Adjustment
WS23-1624	16" to 24"
WS23-2440	24" to 40"
WS23-4072	40" to 72"

Choice of Footrests Depending on Configuration	Top Width		
	48"	60"	72"
2 legs	WS23-2440	WS23-4072	WS23-4072
1 leg and 1 "L" compact cabinet	WS23-2440	WS23-2440	WS23-4072
2 "L" compact cabinets	-	WS23-1624	WS23-2440
1 leg and 1 RA30-2427 cabinet	-	WS23-2440	WS23-4072
1 leg and 1 RA30-3027 cabinet	-	WS23-2440	WS23-2440
1 leg and 1 RA30-3624 cabinet	-	WS23-1624	WS23-2440

Corner Gussets for Leg

WS28

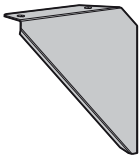

Sold in pairs;
Mount under and attach to leg to reinforce structure;
Recommended for mobile workstations with tops constructed with particleboard or plastic laminate panel;
Note: To find out the capacity of a mobile workstation with gussets, please refer to W54 tech sheet or contact your customer service representative.

Product #
WS28-01

Steel Shelf

WS50 / WS56

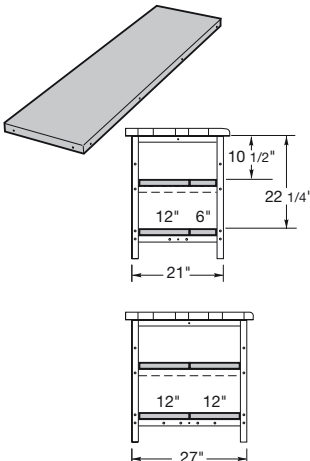

Painted steel: WS50;
Stainless steel: WS56;
Thickness: 1 1/4";
May be installed on leg crossbars or WS24 shelf supports WM27;
Widths: 48", 60" and 72" and depths: 6" and 12";
Shelf combinations:
- 21" deep legs: 1-6" D + 1-12" D shelves
- 27" deep legs: 2-12" D shelves;
To order, complete part # with choice needed.

SEE PAGES 98, 115

Product #	W x D	Surface Width
WS_-4806	45" x 6"	48"
WS_-4812	45" x 12"	48"
WS_-6006	57" x 6"	60"
WS_-6012	57" x 12"	60"
WS_-7206	69" x 6"	72"
WS_-7212	69" x 12"	72"

Ergonomic Footrest

WS27

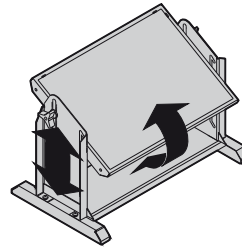

Allows ergonomic adjustment up to 12" in height and a maximum of 30° of inclination;

Adjustments can be made easily and simultaneously;

Equipped with non-skid feet rubber mat glued to the tray;

Fast and simple assembly.

Product #	W x D x H
WS27-2012	20" x 12" x 13"

Shelf Adaptor for Common Leg

WS78

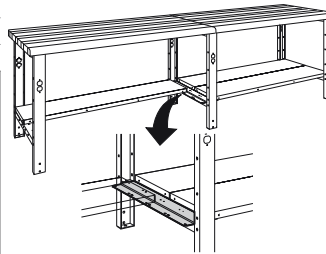

Must be ordered to install WS50 shelves on a common leg.

Product #	Leg Depth
WS78-0321	21"
WS78-0327	27"

Stringer Extension for Common Leg

WS79

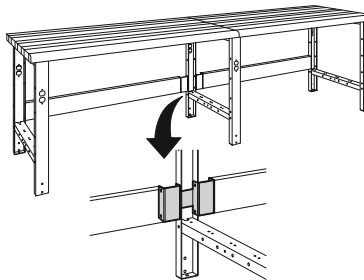

Must be ordered to install WS22 stringers on a common leg.

Product #
WS79-0305

Side Extension for Common Leg

WS64

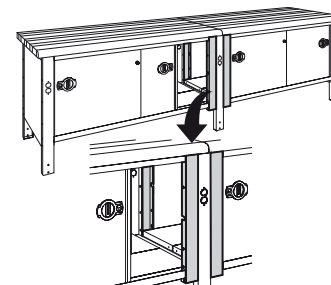

Required to mount WS60 sliding doors or WS63 back panels to a common leg.

Product #	Height
WS64-0325	25"

Components - Structure Under the Work Surface

WORK CENTER

Sliding Doors

WS60 / WS61

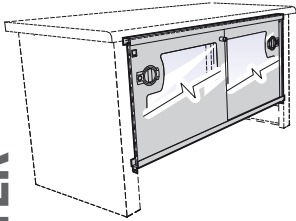

Sliding Doors: WS60;
 Glass Sliding Doors: WS61;
 Allow user to close and lock the area beneath the work surface (standard lock included);
 Smooth, quiet movement;
 Fit workstations with 28", 32" or 34" high legs;
 Order by specifying the choice of door.
 Ex.: WS61-4828L3 for 39" W x 24" H sliding glass doors;
 Compatible with L1 locks; contact your customer service representative.

Product #	W x H	Surface Width
WS_-4828L3	39" x 24"	48"
WS_-6028L3	51" x 24"	60"
WS_-7228L3	63" x 24"	72"

Side Panel

WS62

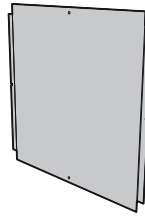

For installation on open legs;
 Fits 28", 32" and 34" high legs.

Product #	D x H	Leg depth
WS62-2128	20" x 25"	21"
WS62-2728	26" x 25"	27"

Back Panel

WS63

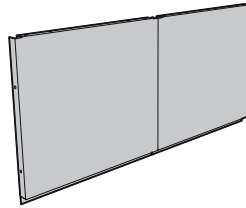

For installation behind WS20 open legs or WS25 closed legs;

Available with:
 - 48" (1 piece)
 - 60" and 72" (2 pieces)

Fits 28", 32" and 34" high legs.

Product #	W x H	Surface width
WS63-4828	39" x 24"	48"
WS63-6028	51" x 24"	60"
WS63-7228	63" x 24"	72"

Finishing panel

WS65 / WS66



Front finishing panel WS65;
 Back finishing panel WS66;
 Allows you to close off the space under a set of sliding doors at both the front and back of the workstation;
 Three heights available: 4", 8" et 10";
 Compatible with tables with closed legs 28", 32" or 34" H.;
 Order by indicating the type of panel and height required.
 Ex.: WS65-4808 for a front finishing panel 48" W x 8" H.

Product #	W x H	Height closed legs
WS_-4804	48" x 4"	28"
WS_-4808	48" x 8"	32"
WS_-4810	48" x 10"	34"
WS_-6004	60" x 4"	28"
WS_-6008	60" x 8"	32"
WS_-6010	60" x 10"	34"
WS_-7204	72" x 4"	28"
WS_-7208	72" x 8"	32"
WS_-7210	72" x 10"	34"

Paper and Cardboard Spool Support

WS86

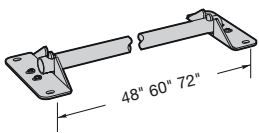

Installs under the work surface on the WS24 leg crossbars (sold separately);
 Includes two end brackets and one rod;
 Rod diameter: 1";
 One person alone may insert the spool by pivoting one end of the rod;
 Capacity: 75 lb.

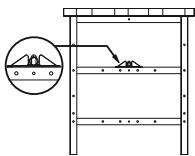

Product #	Width	Color
WS86-48	48"	Black
WS86-60	60"	Black
WS86-72	72"	Black

Packaging Shear Cutter

WM87

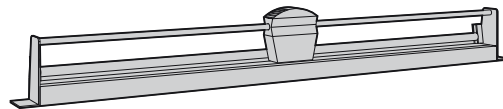

Designed for cutting paper and corrugated rolls, plastic, packing foam, bubble wrap, etc. For materials up to 36" wide;

Cuts in both directions.

Product #	Material Cutting Width	Overall Width
WM87-01	36"	48"

Floor Anchor Hardware Kit

WS80

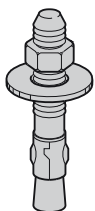

Serves to anchor legs to floor;
 Includes 4 concrete screws.
Product #
 WS80

Leveling Glides

WS26

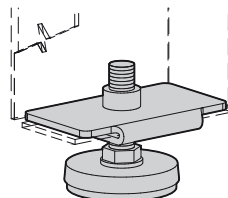

Sold in pairs;
 Serve to adjust the height of legs on uneven floor surfaces;

To use with a "L" compact cabinet, see leveling glide kit LA74.

Product #
WS26

SEE PAGE 103

Components - Structure Under the Work Surface

"L" Compact and "R" Heavy-Duty Preconfigured Models

Here are some of the most popular cabinets for workstations.

"L" compact cabinets:

27" deep cabinets are required for 36" deep workstations and are recommended with a multi-purpose stand and on 30" deep mobile stations;

SEE PAGE 104

Come with RA70 cabinet attachment bars to install and suspend the cabinet under the work surface;

For a 12" drawer: Order LG31 hanging folder bars for letter (8½" x 11") or legal size (8½" x 14") folders;

Can be ordered with or without a central lock (L3). For order a cabinet housing with a central lock, add L3 to product number.

IMPORTANT

Drawer partitions are included in models.

NOTE

For drawers without partitioning, complete the even number following the two last digits of the model.

Ex.: L3ABD-2851C with L3ABD-2852C without

Number of Compartments (layout code)

Drawer dimensions	18" x 21"	18" x 27"
3" to 5"	9 (0206)	9 (0206)
6" and 8"	6 (0104)	6 (0104)
12"	4 (0102)	4 (0104)

KA, KD or MK

SEE PAGE 188

"R" Heavy-duty cabinets:

All models include a 2" recessed base and a central cabinet lock;

Come with RA70 cabinet attachment bars to install the cabinet under the work surface;

The 12" drawer is designed to hold file hanging bars. Order RG30 or RG31 file bars.

SEE PAGE 155

Number of Compartments (layout code)

	24" x 21"	24" x 27"	30" x 21"	30" x 27"
3" to 5"	12 (0308)	20 (0316)	24 (0518)	25 (0420)
6" to 8"	9 (0206)	12 (0209)	12 (0308)	12 (0308)
9" and over	4 (0102)	6 (0104)	6 (0203)	9 (0206)

"L" Compact Cabinet 28" High - Without base



5 drawers	4 drawers	6 drawers	6 drawers	4 drawers
L3ABD-2861 18" x 21" x 28"	L3ABD-2863 18" x 21" x 28"	L3ABD-2865 18" x 21" x 28"	L3ABD-2867 18" x 21" x 28"	L3ABD-2869 18" x 21" x 28"
L3ABG-2861 18" x 27" x 28"	L3ABG-2863 18" x 27" x 28"	L3ABG-2865 18" x 27" x 28"	L3ABG-2867 18" x 27" x 28"	L3ABG-2869 18" x 27" x 28"

"L" Compact Cabinet 32" High - With 4" base



4 drawers	1 door / 1 adjustable shelf	3 drawers	2 drawers	4 drawers
L3ABD-2851_C 18" x 21" x 32"	L3ABD-2854_C 18" x 21" x 32"	L3ABD-2855_C 18" x 21" x 32"	L3ABD-2857_C 18" x 21" x 32"	L3ABD-2859_C 18" x 21" x 32"
L3ABG-2851_C 18" x 27" x 32"	L3ABG-2854_C 18" x 27" x 32"	L3ABG-2855_C 18" x 27" x 32"	L3ABG-2857_C 18" x 27" x 32"	L3ABG-2859_C 18" x 27" x 32"

"R" Heavy-Duty Cabinets - With 2" base

4 drawers	6 drawers	1 drawer / 1 door / 1 bottom shelf	6 drawers	8 drawers
R5ACD-3013 24" x 21" x 32"	R5ACD-3017 24" x 21" x 32"	R5ADD-3013 30" x 21" x 32"	R5ADD-3011 30" x 21" x 32"	R5ADD-4409 30" x 21" x 46"
R5ACG-3013 24" x 27" x 32"	R5ACG-3017 24" x 27" x 32"	R5ADG-3013 30" x 27" x 32"	R5ADG-3011 30" x 27" x 32"	R5ADG-4409 30" x 27" x 46"

WORK CENTER

Components - Structure Under the Work Surface

Drawer Units

To order a drawer unit with locks on drawer, complete the part number with L3.

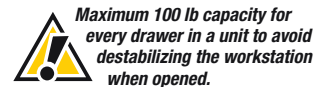
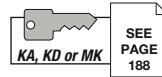

9" High Drawer Unit



1 drawer	
LD75-3201	18" x 21" x 9"
LD75-4201	18" x 27" x 9"



2 drawers	
LD75-3202	18" x 21" x 9"
LD75-4202	18" x 27" x 9"

12" High Drawer Unit



2 drawers	
LD75-3203	18" x 21" x 12"
LD75-4203	18" x 27" x 12"



2 drawers	
LD75-3204	18" x 21" x 12"
LD75-4204	18" x 27" x 12"



3 drawers	
LD75-3205	18" x 21" x 12"
LD75-4205	18" x 27" x 12"

15" High Drawer Unit



2 drawers	
LD75-3206	18" x 21" x 15"
LD75-4206	18" x 27" x 15"



1 drawer	
LD75-3207	18" x 21" x 15"
LD75-4207	18" x 27" x 15"



3 drawers	
LD75-3208	18" x 21" x 15"
LD75-4208	18" x 27" x 15"



"L" Compact Cabinet Components

To order a cabinet or a drawer unit, first select a housing. Then choose doors and/or drawers to correspond with the inside height of the housing.

Now you may also add security, drawer and mobility accessories.

Drawer Unit Housing

LD75

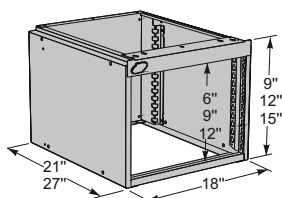

Three standard heights:

- 9" (6" inside)
- 12" (9" inside)
- 15" (12" inside)

Installed on a cabinet or under a work surface;

100 lb capacity for each drawer in the unit for a maximum of 175 lb per unit;

Compatible with LF31 compact drawer (not included);

Order by adding drawer unit housing depth, 21" or 27" deep.

Product #	Inside dim.
LD75-18__09	6"
LD75-18__12	9"
LD75-18__15	12"

Drawer Unit Cover

LD76

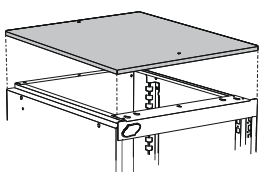

Used to cover the top of the drawer unit when installed on the work surface.

Product #	W x D
LD76-1821	18" x 21"
LD76-1827	18" x 27"

"L" Compact Cabinet Housing

LA30

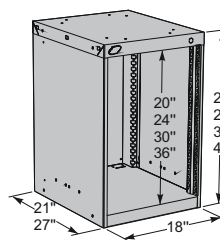

Create a customized work space with a wide range of possibilities;

Four standard heights:

- 24" (20" inside)
- 28" (24" inside)
- 34" (30" inside)
- 40" (36" inside)

Drawers, shelves and doors can be installed in the housing;

Housing is equipped with knock-outs :

- On the top: for stacking a drawer unit housing LD75 or another cabinet. In the later case, order the LA78;
- On the sides and back: for assembling cabinets side-to-side and back-to-back.
- On the sides: for installing under the work surface. Order the RA70.

2" base can be added to make cabinet heights of 26", 30", 36" and 42";

4" base can be added to make cabinet heights of 28", 32", 38" and 44";

Lock on the housing allows user to secure all drawers at the same time, complete the product number with L3;

To order hasp for padlock, complete the product number with LP.

Product #	W x D x H	Product #	W x D x H
LA30-182124	18" x 21" x 24"	LA30-182724	18" x 27" x 24"
LA30-182128	18" x 21" x 28"	LA30-182728	18" x 27" x 28"
LA30-182134	18" x 21" x 34"	LA30-182734	18" x 27" x 34"
LA30-182140	18" x 21" x 40"	LA30-182740	18" x 27" x 40"



27" deep cabinets are recommended for mobile workstations or workstations with multi-purpose frames and are mandatory for all workstations with a 36" deep top.

Components - Structure Under the Work Surface

"L" Compact Drawer

LF31

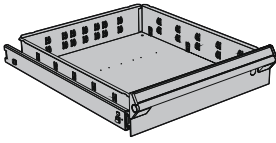

100 lb capacity, 100% extension;
Wide range of accessories available to adapt to your storage needs;
Precision ball bearing drawer slides included;
Easy hook-on assembly;
For drawer layout proposals, see pages 24-25;

Available drawer heights; 3", 4", 5", 6", 8" and 12";

For a 12" drawer: Order LG31 hanging folder bars for letter (8½" x 11") or legal size (8½" x 14") folders;

Order by adding the drawer height to the product number and by specifying the lock-in and the drawer lock. Ex.: LF31-182106B, LF31-182106L3, LF31-182106L3B.

Product #	W x D
LF31-1821	18" x 21"
LF31-1827	18" x 27"



Integrated Door

LB30

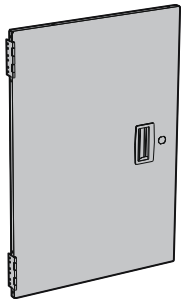

6 standard heights;
Handle fitted in plastic;
Can be installed with hinges on right or left;
Shelf LB24 must be ordered as storage surface for doors installed above a drawer or another door;
For central locking mechanism, complete the product number with L3;
For hasp for padlock, complete the product number with LP.

Product #	W X H
LB30-1812	18" x 12"
LB30-1818	18" x 18"
LB30-1820	18" x 20"

Product #	W X H
LB30-1824	18" x 24"
LB30-1830	18" x 30"
LB30-1836	18" x 36"

Adjustable Shelf

LB24

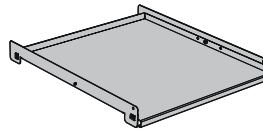

For storing larger, bulkier items;
Equipped with edges along sides and back;
Adjustable in height every 1" c/c;
Capacity up to 100 lb evenly distributed load;
2 versions of the adjustable shelf are possible depending on if the housing is equipped with a central locking mechanism;
Available in galvanized steel;
Order by adding the housing depth - 21" or 27".

Product #	For LA30
LB24-18_01	with L3/LP on the housing
LB24-18_02	without L3/LP on the housing

Cabinet Base

LA85

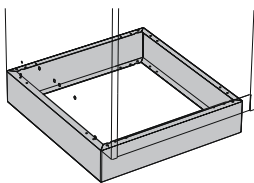

Available heights: 2" and 4";
2" recessed clearance;
Compatible with LA74 leveling glide kit;
Note: not compatible with floor anchoring kit (LA76), stacking kit (LA78) and casters.

Product #	W x D x H
LA85-182102	18" x 21" x 2"
LA85-182104	18" x 21" x 4"
LA85-182702	18" x 27" x 2"
LA85-182704	18" x 27" x 4"

Leveling Glide Kit

LA74

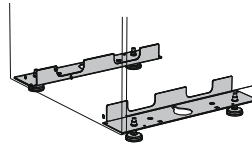

Used to stabilize a cabinet installed on an uneven surface;
Can be installed under cabinets with or without bases;
Includes: 2 supports and 4 leveling glides.

Product #	Width
LA74-1801	18"

Floor Anchoring Kit

LA76

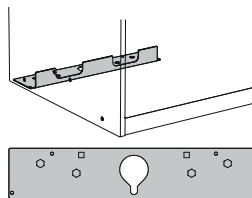

Top view

Used to anchor a cabinet (without base) to the floor;
Includes 1 bolt for concrete floors.

Product #	Width
LA76-1801	18"

Components - Structure Under the Work Surface

Security Accessories

Drawer Lock L3



2 keys provided with each lock;
Compatible with all drawer dimensions;
The mechanism (covered by a galvanized box) requires 3" W x 1" D inside the drawer;
Order by adding L3 to drawer or partitioning number.
Ex: LF31-182106L3;

Note : A security panel LF91 must be ordered to block access between two drawers if managing two different users.



Product #
L3

Central Locking Mechanism L3 / LP



Allows user to lock all drawers in the cabinet at the same time;
Easy to retrofit;
Possible to change drawer layout without touching locking mechanism;
To order a lock, complete the product housing number or the proposal cabinet number by L3. Ex.: LA30-182134L3;
To order a safety hasp for padlock, complete the housing number with LP. Ex.: LA30-182134LP;



Product #
L3 Lock
LP Safety hasp

Door Lock L3 / LP



2 keys provided with each lock;
To order a lock, complete the door number by L3.
Ex: LB30-1812L3;
To order a safety hasp, complete the door number by LP.
Ex: LB30-1812LP;
Note: A security panel LF91 must be ordered to block access between two doors if managing two different users.



Product #
L3 Lock
LP Safety Hasp

Lock-In Mechanism B



Activated by sliding the mechanism with thumb;
Drawer closes without having to reactivate the slide mechanism;
Stops drawers from opening on their own;
Easy to retrofit;
Order by adding B to the drawer or partitioning number.
Ex.: LF31-182106B

Product #
B

Drawer and Handle Accessories

Handle Protector LF70



Installs on drawer handle by clipping in place;
Made of transparent plastic;
Protects identification labels from dust, grease and dirt;
Easy to remove;
Note: Labels available; 30 per page - 10 pages. Order LF71-425075

Product #
LF70-18

PVC Drawer Liner LG40

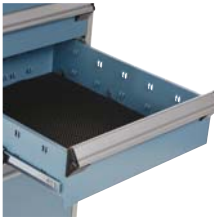

Protects stored objects;
Non-skid surface;
Can be installed under partitions and dividers;
Thickness: 3/32".

Product #	For drawer
LG40-1821-01	18" W x 21" D
LG40-1827-01	18" W x 27" D

Foam for Protection LG41

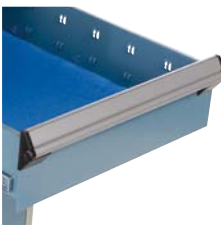

Protects stored objects;
Blue foam 1/4" thick.

Product #	For drawer
LG41-1821-01	18" W x 21" D
LG41-1827-01	18" W x 27" D

NOTE Partitions and dividers may not be installed with this foam.

Foam for Tools LG42



Oil resistant and non-absorbent;
1 blue foam 1/4" thick;
1 black self-adhesive 1/2" thick foam;
Sold without cut-outs. May be cut using a utility knife.

Product #	For drawer
LG42-1821-01	18" W x 21" D
LG42-1827-01	18" W x 27" D

SEE PAGE 189

Folder Hanging Bars LG31



For storing hanging folders;
Can be used for both letter and legal sizes;
Designed for 12" drawers.

Product #
LG31-18

Components - Structure Under the Work Surface

Mobility

4" Casters



LB81



Sold in pairs;
Choice of 3 types of casters: rigid, swivel, swivel with total-lock brake system (on wheel and swivel);
Capacity : 420 lb per caster;
Total height : 5 1/4";
Polyurethane casters (do not mark floors). Superior quality industrial casters;
Requires a LB93 cart or a LB97 base for casters.

Product #	Type of Caster
LB81-01	Rigid
LB81-02	Swivel
LB81-03	Swivel with total-lock brake system

6" Casters



LB84



Sold in pairs;
Choice of 3 types of casters : rigid, swivel, swivel with total-lock brake system (on wheel and swivel);
Capacity : 900 lb per caster;
Total height : 7 1/2";
Polyurethane casters (do not mark floors). Superior quality industrial casters;
Requires a LB93 cart or a LB97 base for casters.

Product #	Type of Caster
LB84-01	Rigid
LB84-02	Swivel
LB84-03	Swivel with total-lock brake system

Cart for Single Cabinet

LB93

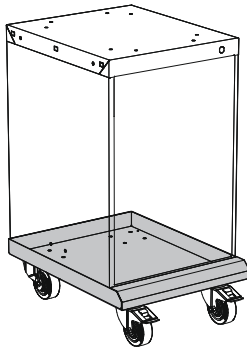

Used when installing casters on a single cabinet;
Installed under 24", 28", 34" or 40" high cabinets without base;
Compatible with 4" and 6" casters (sold separately);
Attention: Mobile cabinets must have load evenly distributed to avoid tipping when opening a drawer.

Product #	W x D
LB93-1821	18" x 21"
LB93-1827	18" x 27"

6" Mag Casters



LB85



Sold in pairs
Choice of 3 types of casters: rigid, swivel, swivel with total-lock brake system (on wheel and swivel);
Aluminium wheel with durable chrome plating;
Capacity: 1000 lb per caster;
Total height: 7 1/2";
Polyurethane casters (do not mark floors). Superior quality industrial casters;
Requires a LB93 cart or a LB97 base for casters.

Product #	Type of Caster
LB85-01	Rigid
LB85-02	Swivel
LB85-03	Swivel with total-lock brake system

Base for Casters

LB97

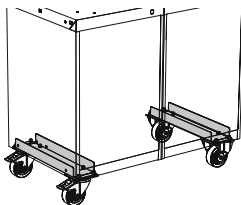

Compatible with 4" and 6" casters (sold separately);
Used to install casters under double or triple cabinets;
Installed under 24", 28", 34" or 40" high cabinets without base;
Note: Sold individually. Order 2 bases for a double cabinet and three bases for a triple cabinet;
Attention: Mobile cabinets must have load evenly distributed to avoid tipping when opening a drawer.

Product #	Depth
LB97-21	21"
LB97-27	27"

Caster Adaptors

WS21

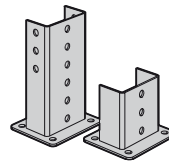

For open legs only;
Sold in pairs;
Two heights available: 3" and 6";
Used for installing casters on WS20 legs.

Product #	Height	Type of Caster
WS21-0306	3"	4" or 6"
WS21-0606	6"	4" or 6"

Components - Structure Under the Work Surface

Heavy-Duty Cabinet Components

WORK CENTER

Heavy-Duty Cabinet Housing

RA30

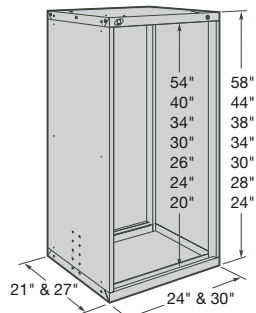

Install modular drawers, roll-out shelves, adjustable and bottom shelves;

To order a standard lock, complete the product number with L3.

Product #	Inside Height	Total Height
24" x 21"		
RA30-242128	24"	28"
RA30-242130	26"	30"
RA30-242134	30"	34"
RA30-242138	34"	38"
24" x 27"		
RA30-242728	24"	28"
RA30-242730	26"	30"
RA30-242734	30"	34"
RA30-242738	34"	38"

Product #	Inside Height	Total Height
30" x 21"		
RA30-302128	24"	28"
RA30-302130	26"	30"
RA30-302134	30"	34"
RA30-302138	34"	38"
RA30-302144	40"	44"
RA30-302158	54"	58"
30" x 27"		
RA30-302728	24"	28"
RA30-302730	26"	30"
RA30-302734	30"	34"
RA30-302738	34"	38"
RA30-302744	40"	44"
RA30-302758	54"	58"

Side Brackets for Top

RA73

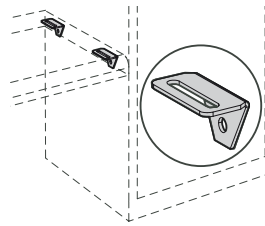

Capacity of 500 lb per pair or 1000 lb for 4;
Compatible with all cabinet depths;
Compatible with all types of work tops;
Galvanized steel.

Product #

RA73-02	1 pair
RA73-04	2 pairs



Bottom Shelf

RB23 / RB25

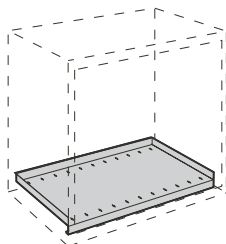

For storing bulky items;

Has edges along the sides and back to prevent items from falling into the bottom of the cabinet;

Up to 400 lb capacity of evenly distributed load;

SH52 dividers can be installed.

Product #	W x D	Capacity
RB23-2421	24" x 21"	200 lb
RB23-2427	24" x 27"	200 lb
RB25-3021	30" x 21"	400 lb
RB25-3027	30" x 27"	400 lb

Note : For compatibility with double integrated doors, order an adjustable shelf.

Adaptor for WS50 Shelf

RC15

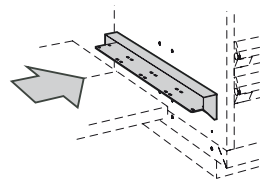

Allows for installation of a WS50 shelf between 2 RA30 cabinets or between a RA30 cabinet and a WS20 leg;

Attached in the holes on side of cabinet (knock-outs provided).

Product # **Depth**

RC15-12	12" (1-12" D shelf or 2-6" D)
RC15-18	18" (1-12" D shelf+1-6" D or 3-6" D)
RC15-24	24" (2-12" D shelves or 4-6" D)



Adjustable Shelf

RB22 / RB24

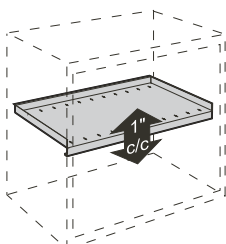

For storing bulky items;

Has edges along the sides and back to prevent items from falling into the bottom of the cabinet;

Adjustable every 1" c/c;

Up to 400 lb capacity of evenly distributed load;

SH52 dividers can be installed.

Product #	W x D	Capacity
RB22-2421	24" x 21"	200 lb
RB22-2427	24" x 27"	200 lb
RB24-3021	30" x 21"	400 lb
RB24-3027	30" x 27"	400 lb

Partial Divider

PATENTED

SH52

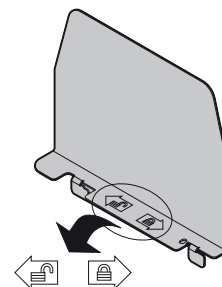

Unique patented design that makes spacing changes easier;

Height: 5 1/2";

Attach easily: no screws required.

Product # **True depth** **For shelves**

SH52-1806	13 1/8"	21" D
SH52-2406	19 1/8"	27" D

Pictograms to facilitate installation

Components - Structure Under the Work Surface

WORK CENTER

Recessed Base

RA55

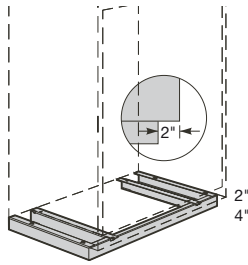

Designed to raise the height of a cabinet by 2" or 4";
 Compatible with RA56 straight cover plate for back;
 Includes a removable cover plate at the front for aesthetics and in order to move the cabinet from the front;
 Front cover plate is on a straight angle to facilitate cleaning floors;
 Leaves a 2" space to allow user to stand closer to cabinet;
 Designed to allow user to anchor the cabinet to the floor;
 Compatible with leveling glides (RA74);
 Note: Not compatible with casters;
 Note: Not designed for stacking applications.

Product #	W x D	Height
RA55-242102	24" x 21"	2"
RA55-242702	24" x 27"	2"
RA55-302102	30" x 21"	2"
RA55-302702	30" x 27"	2"
RA55-242104	24" x 21"	4"
RA55-242704	24" x 27"	4"
RA55-302104	30" x 21"	4"
RA55-302704	30" x 27"	4"

Forklift Base

RA52 / RA53

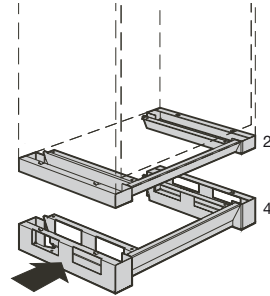

2" high base designed for moving the cabinet from the front with a forklift;
 4" high base designed for moving the cabinet from the front or side with a forklift, or from the front with a pallet-jack;
 Compatible with the RA54 rear base cover plate, offered as an option;
 Includes a recessed kick-plate in the center of the cabinet to allow user to stand closer to cabinet;
 Designed to enable user to anchor cabinet to the floor;
 Compatible with leveling glides (RA74);
 Note: Not compatible with casters.

Product #	W x D	Height
RA52-242102	24" x 21"	2"
RA52-242702	24" x 27"	2"
RA52-302102	30" x 21"	2"
RA52-302702	30" x 27"	2"
RA53-242104	24" x 21"	4"
RA53-242704	24" x 27"	4"
RA53-302104	30" x 21"	4"
RA53-302704	30" x 27"	4"

Straight Cover Plate

RA56

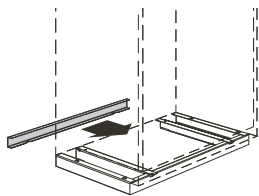

Closes off the back of 2" and 4" recessed bases.

Product #	W x H
RA56-2402	24" x 2"
RA56-2404	24" x 4"
RA56-3002	30" x 2"
RA56-3004	30" x 4"

Angled Cover Plate

RA54

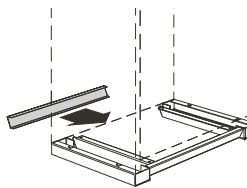

Closes off the back of 2" and 4" forklift bases.

Product #	W x H
RA54-2402	24" x 2"
RA54-2404	24" x 4"
RA54-3002	30" x 2"
RA54-3004	30" x 4"

4" Casters



RB81



Sold in pairs;
 Choice of 3 types of casters: rigid, swivel, swivel with total-lock brake system (on wheel and swivel);
 Capacity : 420 lb per caster;
 Total height : 5 1/4";
 Polyurethane casters (do not mark floors). Superior quality industrial casters;
 Install directly under cabinet without base.

Product #	Type of Caster
RB81-01	Rigid
RB81-02	Swivel
RB81-03	Swivel with total-lock brake system

6" Casters



RB84



Sold in pairs;
 Choice of 3 types of casters: rigid, swivel, swivel with total-lock brake system (on wheel and swivel);
 Capacity : 900 lb per caster;
 Total height : 7 1/2";
 Polyurethane casters (do not mark floors). Superior quality industrial casters;
 Install directly under cabinet without base.

Product #	Type of Caster
RB84-01	Rigid
RB84-02	Swivel
RB84-03	Swivel with total-lock brake system

6" Mag Casters



RB85



Sold in pairs
 Choice of 3 types of casters: rigid, swivel, swivel with total-lock brake system (on wheel and swivel);
 Aluminium wheel with durable chrome plating;
 Capacity: 1000 lb per caster;
 Total height: 7 1/2";
 Polyurethane casters (do not mark floors). Superior quality industrial casters;
 Install directly under cabinet without base.

Product #	Type of Caster
RB85-01	Rigid
RB85-02	Swivel
RB85-03	Swivel with total-lock brake system

Leveling Glide Kit

RA74

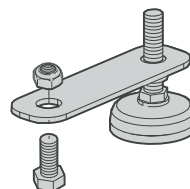

Sold in kits of 4;
 Serves to adjust the height of cabinet housings on uneven floor surfaces.

Product #
RA74-01

Components – Structure Under the Work Surface

Drawers, Roll-out Shelves and Locking or Security Mechanisms

WORK CENTER

Modular Drawers for Cabinet

RF31



400 lb capacity, 100% extension;
Heavy-duty construction;
Easy to install;
Vast choice of accessories offered to adapt to your storage needs;

SEE PAGES 151-155

Available drawer heights: 3", 4", 5", 6", 7", 8", 9", 10", 12" and 14";

Order by adding the drawer height to the part #
Ex.: RF31-302406;

For modular drawers with layouts,

SEE PAGES 137-150

Product #	W x D
RF31-2421	24" x 21"
RF31-2427	24" x 27"
RF31-3021	30" x 21"
RF31-3027	30" x 27"

Heavy-Duty 3-Sided Access Roll-Out Shelf

RF44



400 lb capacity, 100% extension;
Heavy-duty construction;
Easy to install;
Galvanized steel with 1 1/2" edge on back;
Height: 5";
May serve as work surface.

Product #	W x D
RF44-2421	24" x 21"
RF44-2427	24" x 27"
RF44-3021	30" x 21"
RF44-3027	30" x 27"

Lock-Out Mechanism

RF85



For both drawers and roll-out shelves;
Locks drawers and roll-out shelves in open position;
Activated manually, only when required;
No interference with drawer accessories.

Product #
RF85

Handle Protector

RF70



Clips onto the drawer handle;
Made of transparent plastic;
Protects identification labels on drawers from dust, grease and other debris;
Easy to remove when required;
Labels sold separately.

SEE PAGE 153

Product #	Width
RF70-24	24"
RF70-30	30"

Heavy-Duty Front Access Roll-Out Shelf

RF40



400 lb capacity, 100% extension;
Heavy-duty construction;
Easy to install;
Painted steel with 3" edges on sides and back;
Height: 6";
Full access to contents.

Product #	W x D
RF40-2421	24" x 21"
RF40-2427	24" x 27"
RF40-3021	30" x 21"
RF40-3027	30" x 27"

Integrated Lock-In Mechanism



A



Activated by tilting the handle up;
Allows user to open the drawer and the roll-out shelf with one hand only;
Close by simply pushing it;
Stops drawer and roll-out shelf from opening on their own;
Easy to retrofit;
Order by adding A to the drawer or partitioning model number or roll-out shelf.
Ex.: RF31-302406A.

Product #
A

Econo Lock-In Mechanism

B

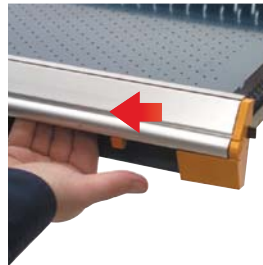

Activated with the right hand by sliding the mechanism with thumb;
Drawer and roll-out shelf close without having to reactivate the slide mechanism;
Stops drawer and roll-out shelf from opening on their own;
Easy to retrofit;
Order by adding B to the drawer or partitioning model number or roll-out shelf.
Ex.: RF31-302406B.

Product #
B

Drawer Lock

L3

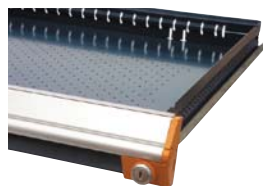

Compatible with all drawer dimensions;
Does not affect usable drawer space;
Easy to retrofit;
Order by adding L3 to drawer or partitioning model number. Ex.: RF31-302406L3.

Product #
L3



SEE PAGE 188

Components - Structure Under the Work Surface

Doors

Single Integrated Door, Solid or Glass RB30 / RB31

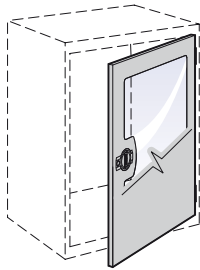

Integrated door: RB30;
 Integrated glass door: RB31;
 Compatible with RB23/RB25 bottom shelf and RB22/RB24 adjustable shelf;
 Opens 180° for full access to items stored inside;
 Factory installed on RA30 cabinet housings;
 Standard lock included;
 Some heights may be combined with drawers mounted above or below. In the latter case, you must order a RB22 or RB24 adjustable shelf for installation above the section of drawers;

Glass door made of impact resistant polycarbonate;

Order by specifying the type of door.
 Ex.: RB31-3034L3 for 30" W x 34" H integrated glass door;

Note: Not compatible with RF31 drawer or RF40/RF44 roll-out shelf.



Double Integrated Doors, Solid or Glass RB35 / RB36

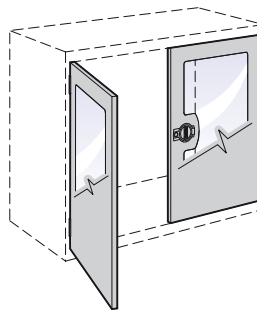

Integrated door: RB35;
 Integrated glass door: RB36;
 Compatible with RB24 adjustable shelf;
 Opens 180° for full access to items stored inside;
 Factory installed on RA30 cabinet housings;
 Standard lock included;

Some heights may be combined with drawers mounted above or below. In the latter case, you must order a RB24 adjustable shelf for installation above the section of drawers, or a crossbar for drawers mounted above;

Glass doors made of impact resistant polycarbonate;

Order by specifying the type of door.
 Ex.: RB36-3020L3 for 30" W x 20" H integrated glass doors;

Note: Not compatible with RB25 bottom shelf;

Note: Not compatible with RF31 drawer or RF40/RF44 roll-out shelf.

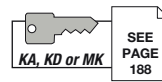

Product #	W x H
RB_-2420L3	24" x 20"
RB_-2424L3	24" x 24"
RB_-2426L3	24" x 26"
RB_-2430L3	24" x 30"
RB_-2434L3	24" x 34"
RB_-3020L3	30" x 20"

Product #	W x H
RB_-3024L3	30" x 24"
RB_-3026L3	30" x 26"
RB_-3030L3	30" x 30"
RB_-3034L3	30" x 34"
RB_-3040L3	30" x 40"
RB_-3054L3	30" x 54"

Product #	W x H
RB_-3020L3	30" x 20"
RB_-3024L3	30" x 24"
RB_-3026L3	30" x 26"
RB_-3030L3	30" x 30"
RB_-3034L3	30" x 34"
RB_-3040L3	30" x 40"
RB_-3054L3	30" x 54"

Crossbar for Double Integrated Doors RB70

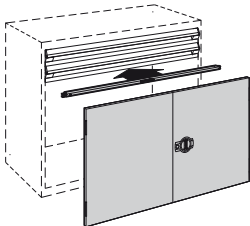

Required for double integrated doors with drawer above.

Product #	Width
RB70-30	30"



R5WH4-2006

Sink Cabinets

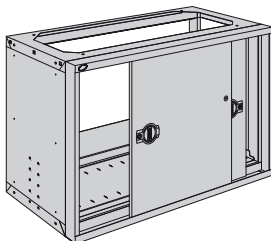

The top has an opening to allow for installation of a sink;

Has an opening on the back on the housing to allow for installation of a drain and pipes;

1 bottom shelf;

Models that have a door with frame are compatible with drawers and roll-out shelves;

Standard lock included;

Compatible with bases;

Heights available: 28", 30" and 34";

Complete the part # with height wanted and by referring to chart below for door types;

Ex.: R5TDD-2801;

Note: Sink is not included;

SEE PAGE 108



Note: Work surfaces must be ordered separately (cut-outs are not provided by Rousseau).

SEE PAGE 96

Product #	W x D
R5TDD-___*	30" x 21"
R5TDG-___*	30" x 27"
R5THD-___	48" x 21"
R5THG-___	48" x 27"



R5XDH-3002

01	For cabinet with single integrated door
02	For cabinet with double integrated doors
03	For cabinet with double doors with frame
04	For cabinet with integrated sliding doors
05	For cabinet with sliding doors with frame

*Models are not compatible with sliding doors.

Components - Structure Above the Work Surface

Riser Shelves

WORK CENTER

Steel

WS50



Thickness: 1 1/4";
May be installed on all types of shelf supports;
True width = nominal width - 3".

Laminated Wood

WS51



Made from varnished hardwood slats;
Thickness: 1 1/4";
May be installed on WS54, WS55, WS59 and WM27-1202 shelf supports;
Attractive appearance.

Plastic Laminated

WS52



Color: White;
Thickness: 1 1/4";
May be installed on WS54, WS55, WS59 and WM27-1202 shelf supports;
Attractive appearance.

Dissipative

WS53



Dissipates electric charges that can damage electronic components;
Resistance point to point and point to ground between 10⁶ and 10⁹ Ω;
Color: White;
Thickness: 1 1/4";
May be installed on WS54, WS55, WS59 and WM27-1202 shelf supports.

Stainless Steel

WS56



Thickness: 1 1/4";
Brushed finish # 4;
May be installed on all types of shelf supports;
True width = nominal width - 3".

Resistant Acrylic/PVC Plastic Laminated

WS57



Color: gray;
Thickness: 1 1/4";
May be installed on WS54, WS55, WS59 and WM27-1202 shelf supports.

Dimensions		Type of Shelf					
W	D	Painted steel	Laminated wood	Plastic laminate	Dissipative	Stainless steel	Acrylic/PVC laminate
48"	12"	WS50-4812 *	WS51-4812	WS52-4812	WS53-4812	WS56-4812	WS57-4812
60"	12"	WS50-6012 *	WS51-6012 *	WS52-6012 *	WS53-6012 *	WS56-6012	WS57-6012*
72"	12"	WS50-7212 *	WS51-7212 *	WS52-7212 *	WS53-7212 *	WS56-7212	WS57-7212*

NOTE *Stock items. Other models are available on manufacturing schedules only.

Riser Shelf Supports

WS54

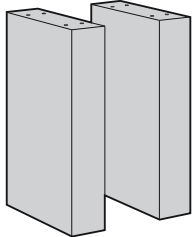

Sold in pairs;
Accommodate WS50 (12" D), WS51, WS52, WS53, WS56, WS57 shelves;
Height: 16";
Attractive appearance.

Product #	W x D x H
WS54-16	3" x 10 1/4" x 16"

Riser Shelf Supports with Electrical Outlets on Both Sides

WS55

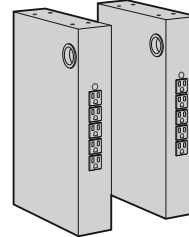

Sold in pairs;
Each support is equipped with a power strip with 5 outlets;
Accommodate WS50 (12" D), WS51, WS52, WS53, WS56, WS57 shelves;
Height: 16";
Attractive appearance.

Product #	W x D x H
WS55-16	3" x 10 1/4" x 16"

Riser Shelf Supports with Electrical Outlets on One Side

WS59

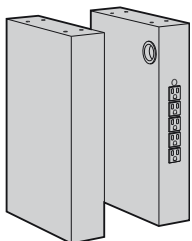

Sold in pairs;
One support is equipped with a power strip with 5 outlets;
Accommodate WS50 (12" D), WS51, WS52, WS53, WS56, WS57 shelves;
Height: 16";
Attractive appearance.

Product #	W x D x H
WS59-16	3" x 10 1/4" x 16"

Econo Riser Shelf Supports

WS82

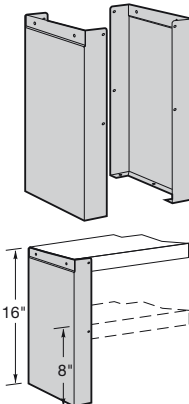

Sold in pairs;
Permit installation of one or two shelves (12" D);
Accommodate WS50 and WS56 shelves only;
Total height: 16";
Mid-height shelf: 8";
Easy to assemble.

Product #	Height
WS82-1601	16"

Components – Structure Above the Work Surface

Shelf Back or Front Stop

WS58 / WS99

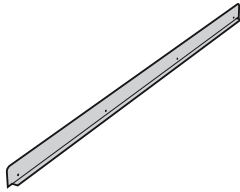

Painted steel: WS58;
 Stainless steel: WS99;
 May be attached to WS50, WS51, WS52, WS53, WS56, WS57 shelves;
 Prevents objects from falling from fixed or adjustable riser shelves;
 Clears shelf by 1";
 To order, complete product # with steel choice needed. Ex.: WS58-48.

Product #	W x H	For Shelf
WS_-48	45" x 2 1/4"	48" W
WS_-60	57" x 2 1/4"	60" W
WS_-72	69" x 2 1/4"	72" W

Back Panel for Riser Shelf

WS83 / WS93

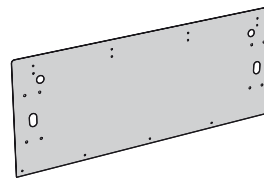

Painted steel: WS83;
 Stainless steel: WS93;
 Mounted at the back of the work area and the riser shelf;
 May be mounted on all surfaces or on any shelf;
 Holes for cables;
 Height: 20". Exceeds the riser shelf to prevent objects from falling;
 To order, complete product # with steel choice needed. Ex.: WS83-4616.

Product #	Width
WS_-4816	48"
WS_-6016	60"
WS_-7216	72"

Lighting Fixture for Riser Shelf

WS84

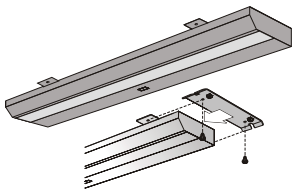

Eliminates shaded areas beneath riser shelves;
 May be mounted on all types of riser shelves;
 Adaptors for WS50 steel riser shelf included;
 T8 fluorescent tube included;
 Includes K12 acrylic outlet, 10' power cord and switch;
 Color: Black;
 T8 ballast as energy saver.

Product #	For Shelves
WS84-36T8	48" and over
WS84-48T8	60" and over



WSC2017



Components - Structure Above the Work Surface

Electronic Applications

Power Outlet Strip

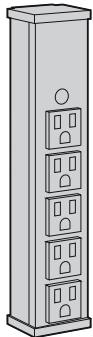

15A strip equipped with breakers and 6' extension cord;

Mounted horizontally beneath the work surface or the riser shelf;

Installation hardware included.

Product #	H	No. of Outlets
70000500	9"	5 Without on/off switch
70000505	12"	6 With on/off switch
70000520	48"	8 With on/off switch



LC3004C

Grounding Block

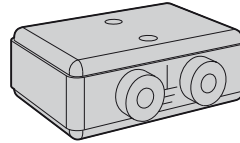

2 outlets for ground wrist strap;

Comes with 10' long grounding cord;

Dissipates electric charges that could damage electronic components.

Product #
70000350

Grounding Cord

WS89

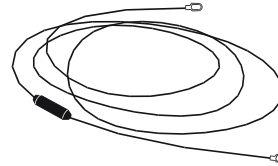

Links dissipative top or shelf to grounding block or directly to ground;

Dissipates electric charges that could damage electronic components;

10' long.

Product #

70000300 Used to ground workstation. 1M Ω resistance.

WS89-01 Used to ground all components on the workstation to a common grounding point.

Ground Wrist Strap

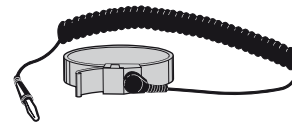

Stretch material;

6' cable;

Dissipates electric charges that could damage electronic components; 1M Ω resistance.

Product #

70000320



Conductive Plastic Bin



RG21

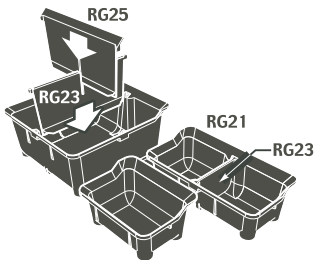

Dissipates electric charges that could damage electronic components;

Color: Black;

Makes storing, moving and inventory of small parts easier. Lightweight and resistant;

Compatible with WM55 louvered panel, WM28 plastic bin rail and 3" and 4" high drawers;

Edge at 45° angle for easy identification and easy removal of parts;

6" bins can be divided.



Dimensions			Bin	Product # Partition	Divider
W	D	H			
3"	3"	2"	RG21-030302	-	-
4"	3"	2"	RG21-040302	-	-
6"	3"	2"	RG21-060302	RG22-0302	-
6"	6"	2"	RG21-060602	RG22-0602	RG24-0602
3"	3"	3"	RG21-030303	-	-
4"	3"	3"	RG21-040303	-	-
6"	3"	3"	RG21-060303	RG22-0303	-
6"	6"	3"	RG21-060603	RG22-0603	RG24-0603

Components – Structure Above the Work Surface

Multi-Purpose Frame Components

Multi-Purpose Upright

WM10

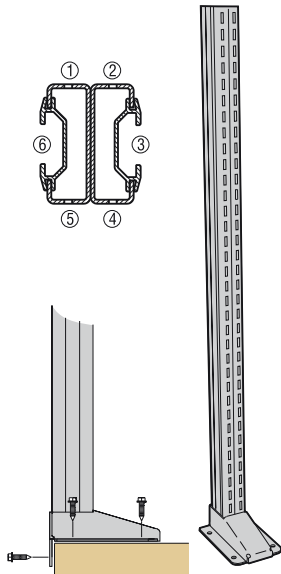

May be installed on most workbench tops offered on the market. Requires a good quality top, at least 1 1/2" thick;

Characterized by its shape and rigidity;

Offers up to six fixing zones for a minimum of interference between components;

Perforated on front and back faces at 1" c/c intervals for optimum adjustment of accessories ① ② ④ ⑤;

Features two black aluminum extrusions on the sides for infinitely adjustable accessories ③ ⑥;

Five anchor points on the foot ensure stability on the two main axes;

Symmetrical shape means the upright may be used for back-to-back workstations;

The 48" height is ideal for overhead accessories.

Product #	Height
WM10-24	24"
WM10-36	36"
WM10-48	48"

WM Unit Frame

WM11

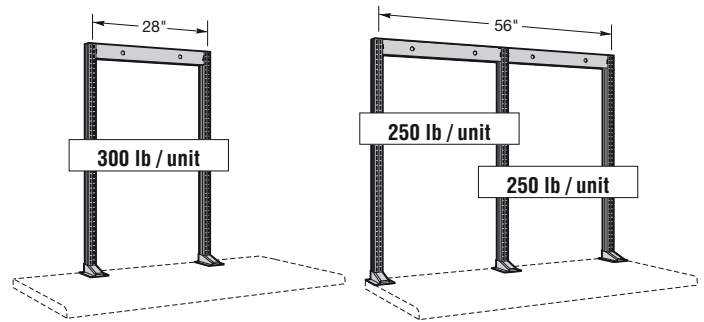

The single unit frame consists of:
- 2 WM10 uprights
- 1 WM15 upright cross member

Capacity: 300 lb per unit frame.

The double unit frame consists of:
- 3 WM10 uprights
- 2 WM15 upright cross members

Capacity: 250 lb per unit frame
(Total: 500 lb).

Product #	W x H	W Required
WM11-2836	28" x 36"	36" min.
WM11-2848	28" x 48"	36" min.

Product #	W x H	W Required
WM11-5636	56" x 36"	60" min.
WM11-5648	56" x 48"	60" min.

Top Flange for WM10 Upright

WS18

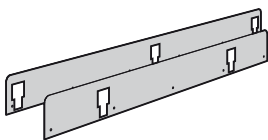

Specially designed to fit with WM10 uprights;

Installs on all types of tops;

Height: 5". Exceeds top by approx. 3 1/4";

Designed for an upright that is centered on the workstation.

Product #	Width	Application
WS18-360502	36"	For 2 WM uprights
WS18-480502	48"	For 2 WM uprights
WS18-600502	60"	For 2 WM uprights
WS18-600503	60"	For 3 WM uprights
WS18-720502	72"	For 2 WM uprights
WS18-720503	72"	For 3 WM uprights

Upright Cross Member

WM15

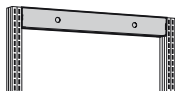

Strengthens unit frames;

Hooks onto WM10 uprights and can be secured in place;

Includes two knockouts for pneumatic connectors.

Product #	Width (c/c)
WM15-28	28"
WM15-56	56"

Gantilever Overhead Supports

WM18

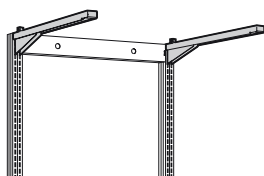

Sold in pairs;

Clip onto WM10 uprights;

Lock in place with a safety latch located on the top of the support;

Capacity: are designed to hold a WM45 overhead workstation light and one WM47 tool rail, or two WM47 tool rails.

Product #	Depth	Color
WM18-26	26"	Black



Top Reinforcer

WM14

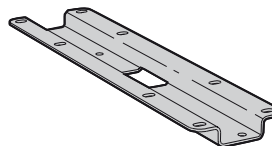

Required for work tops less than 1 1/2" thick, in poor condition or back-to-back workstations;

Used to strengthen the anchor points of the WM10 upright;

Fastened to the underside of the work surface.

Product #	W x D	Color
WM14-01	4" x 16"	Black

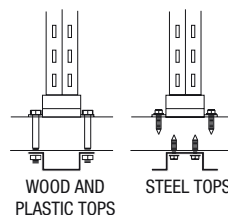

Recommended with work tops other than Rousseau's.

Components - Structure Above the Work Surface

WORK CENTER

Multi-Purpose Wall Mounted Frame

WM35

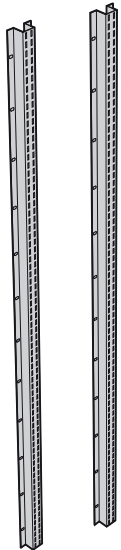

300 lb capacity (wall and wall anchoring must be strong enough);

Up to 500 lb capacity for a combination of 3 uprights;

Perforated on front face at 1" c/c intervals for optimum adjustment of accessories;

Wall anchoring not included;

Compatible accessories (space between uprights must be 28" c/c):

- WM18 cantilever overhead supports
- WM20 tiltable shelf
- WM22 tiltable pan
- WM27 structural shelf supports
- WM28 plastic bin rail
- WM31 wire spool support
- WM40 power outlet channel
- WM55 louvered panel for plastic bins
- WM75 storage cabinet
- RD00 wall cabinet (with RD08 adaptors)
- WM Adaptor NC50 (with tool rack NC10 / NC12)



Product #	Height	Number of Uprights
WM35-7201	72"	1
WM35-7202	72"	2
WM35-7203	72"	3

Wall Mounted Perforated Panel

WM51 / WM56

Painted steel perforated every 1" c/c;

Used to hang accessories or tools;

Two options: - For the WM35 frame (includes set of adaptors);

- For hanging directly on the wall.

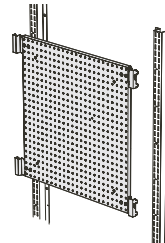

Product #	W x H	Model
WM51-2424	24" x 24"	For WM35 frame
WM51-2436	24" x 36"	For WM35 frame
WM56-2424	24" x 24"	Wall mounted
WM56-2436	24" x 36"	Wall mounted
WM56-2472	24" x 72"	Wall mounted

Tiltable Shelf

WM20

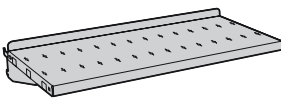

Clips onto WM10 uprights;

Slotted to receive SH52 dividers at every 2" c/c;

Includes 2 side supports that may be placed at right angles or at an angle of 15°;

The shelf is reversible and its edge may serve as a back stop for plastic bins or binders;

Capacity: 100 lb, evenly distributed load.

Product #	W x D
WM20-2808	28" x 8"
WM20-2812	28" x 12"

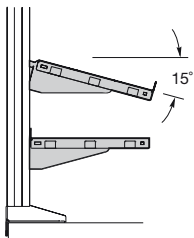

Partial Divider

PATENTED

SH52

Unique patented divider;

May be used with WM20 8" and 12" deep shelves; adjustable every 2" c/c;

Installed in the shelf slots, forward or backward.

Product #	D x H
SH52-1206	8" x 6"

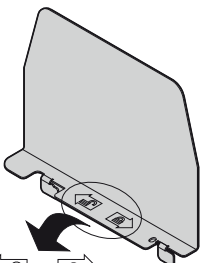

Pictograms to facilitate installation



Components – Structure Above the Work Surface

WORK CENTER

Shelf

WS50 / 51 / 52 / 53 / 56 / 57



Installed on WM10 uprights with WM27 shelf supports;

Capacity: 200 lb;

Possible to add WS58 or WS99 shelf back or front stop;

Thickness: 1 1/4".

Product #	W x D	Type of Shelf
WS50-6012	56 3/4" x 12"	Steel
WS51-6012	60" x 12"	Laminated wood
WS52-6012	60" x 12"	Plastic laminate
WS53-6012	60" x 12"	Dissipative
WS56-6012	60" x 12"	Stainless steel
WS57-6012	60" x 12"	Acrylic/PVC laminate

Structural Shelf Supports

WM27

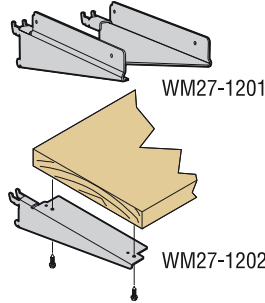

Sold in pairs;

Clip onto WM10 uprights;

Used with all types of 48", 60" or 72" wide shelves;

May be positioned at a right angle or inclined at an angle at 15°.

Product #	Depth for Shelves
WM27-1201	12" WS50, WS56
WM27-1202	12" WS51, WS52, WS53, WS57

Sliding Divider

WS87

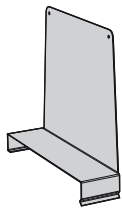

Clips onto a 12" deep WS50 steel shelf installed above or below the work surface;

Not compatible for use with WS58 shelf with a back or front stop.

Product #	D x H
WS87-1210	12" x 10"

Tiltable Pan

WM22

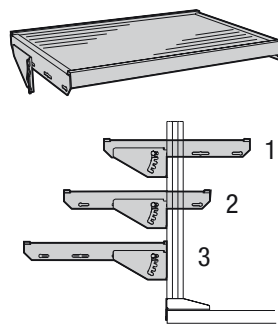

Clips onto WM10 uprights;

Three positions: front, center and back;

Unique feature: may be easily tilted from 0 to 30° with 5 adjustment positions;

Full-size rubber mat included;

Usable space: 24 1/2" x 18 1/2";

Capacity: 200 lb.

Product #	W x D
WM22-2820	28" x 20"

Plastic Bin Rail

WM28

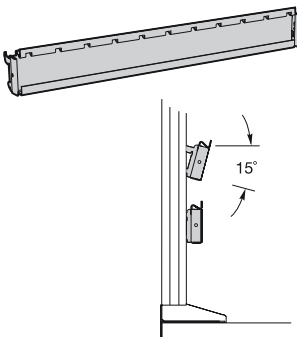

Clips onto the WM10 uprights; adjustment every 1" c/c;

Suited to all makes of plastic bins with hanger lip sold on the market;

Can receive all sizes of RG20 plastic bins;

Capacity: 75 lb, evenly distributed load.

SEE PAGE 116

Product #	Width
WM28-2801	28"



Tool Support

WM30

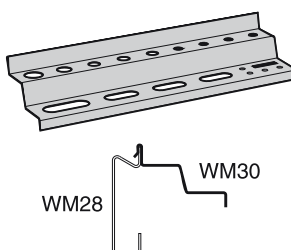

Made of galvanized steel;

Installs on WM20 shelf, WM28 plastic bin rail or on WM62 monitor tray;

Features holes of several sizes to hang tools.

Product #	Width
WM30-01	12"

Wire Spool Support

WM31

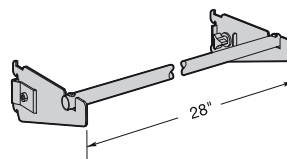

Includes 2 side supports and a 3/4" diameter rod;

Capacity: 50 lb.

Product #	Width
WM31-2801	28"

Components - Structure Above the Work Surface

WORK CENTER

Plastic Bin



RG20



Make storing, moving and inventory of small parts easier. Lightweight and resistant;

Edge at 45° angle for easy identification and easy grasp of bins;

Compatible with WM55 louvered panel and WM28 plastic bin rail;

6" bins can be divided.

Dimensions			Bin	Product # Partition	Divider
W	D	H			
3"	3"	2"	RG20-030302	-	-
4"	3"	2"	RG20-040302	-	-
6"	3"	2"	RG20-060302	RG22-0302	-
6"	6"	2"	RG20-060602	RG22-0602	RG24-0602
3"	3"	3"	RG20-030303	-	-
4"	3"	3"	RG20-040303	-	-
6"	3"	3"	RG20-060303	RG22-0303	-
6"	6"	3"	RG20-060603	RG22-0603	RG24-0603

Paper and Cardboard Spool Support

WM86

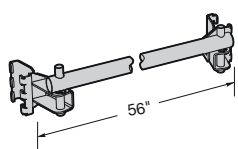

Installs on WM10 uprights to create a packaging station;

Includes two end brackets and one rod;

Rod diameter: 1";

One person alone may insert the spool by pivoting one end of the rod;

Capacity: 75 lb.

Product #	Width	Color
WM86-56	56"	Noir

Tool Rail

WM47

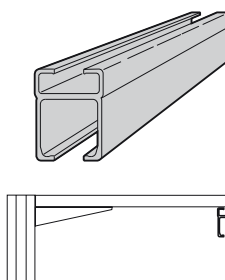

Allows the installation of one or more WM48 balancer trolley;

Installs on WM18 cantilever overhead supports (sold separately);

Easily adjustable depth;

Capacity: 25 lb.

Product #	Width	Color
WM47-4801	48"	Black
WM47-6001	60"	Black

Joiner for Tool Rail

WM89

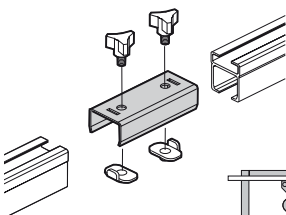

Allows assembly of two WM47 tool rails on adjacent workstations.

Product #
WM89-01

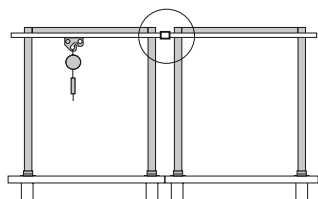

Balancer Trolley

WM48

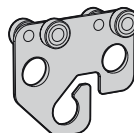

Inserts into the WM47 tool rail;

Can receive a pneumatic connector.

Product #	Color
WM48-01	Black

Tool Balancer

WM49

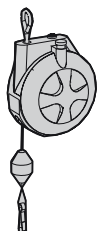

Allows hanging of tools overhead, above the work surface;

Six foot metal cable with tension adjustment;

Capacity: up to 3 lb.

Product #	Color
WM49-01	Black

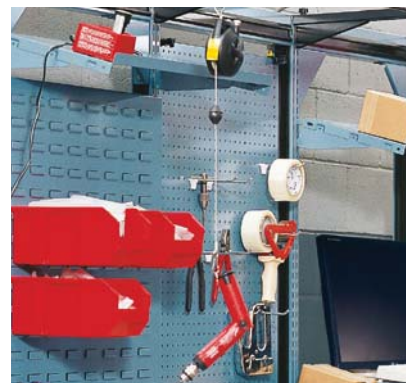

Components – Structure Above the Work Surface

WORK CENTER

Computer Supports for Work Surface

Laptop Support



RC58-01



Can be used for a laptop computer or an electronic devise etc;
 Usable tray surface 14" W X 12" D;
 Installs on the work surface, with the RC68/RC69 finishing panel for computer support;
 Compatible with the following work surfaces : WS14, RC35, RC36, RC37;
 Stainless steel upright, 17" H;
 Arm, adapter and tray in painted steel. Color : black;
 The tray for laptop is adjustable at 13" height to accommodate different users;
 The tray is equipped with non-slip strips (Velcro®) to ensure the laptop doesn't slide.

Product #
 RC58-01

LCD Monitor Support



RC57-01



Can be used to support most LCD monitors available on the market ;
 Installs on the work surface, with the RC68/RC69 finishing panel for computer support.
 Compatible with the following work surfaces : WS14, RC35, RC36, RC37;
 Stainless steel upright, 17" H;
 Arm and adapter in painted steel. Color: black;
 The LCD monitor support is adjustable at 13" height to accommodate different monitor dimensions and different users;
 Positioning of monitor anchors according to VESA75 and 100 standards.

Product #
 RC57-01

LCD Monitor, Keyboard and Mouse Support

RC58-02



Installs on the work surface, with the RC68/RC69 finishing panel for computer support;
 Compatible with the following work surfaces : WS14, RC35, RC36, RC37;
 Stainless steel upright, 17" H;
 Arm, adaptor and tray in painted steel. Color: black;
 The keyboard and mouse tray is adjustable at 13" height to accommodate different users;
 Usable surface of the keyboard and mouse tray : 23 5/8" W x 8 1/2" D;
 The LCD monitor support is adjustable at 13" height to accommodate different monitor dimensions and different users;
 Can support most LCD monitors available on the market;
 Positioning of monitor anchors according to WESA75 and 100 standards.

Product #
 RC58-02

Double LCD Monitor Support



RC57-03



Can be used to support two LCD monitors ;
 Installs on the work surface, with the RC68/RC69 finishing panel for computer support.
 Compatible with the following work surfaces : WS14, RC35, RC36, RC37;
 Stainless steel upright, 17" H;
 Arm and adapter in painted steel. Color: black;
 The LCD monitor support is adjustable at 13" height to accommodate different monitor dimensions and different users;
 Positioning of monitor anchors according to VESA75 and 100 standards.

Product #
 RC57-03

Light-Duty Arm for Multi-Purpose Frames

Light-Duty Arm Adaptor

WM68

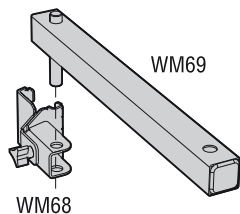

Quick assembly on WM10 uprights;
 Allows the attachment of different makes of lamps or document holders with a 1/2" diameter rod pivot;
 Capacity: 20 lb.

Product # **Color**
 WM68-01 Black

Light-Duty Arm

WM69

Attaches to the WM68 light-duty arm adaptor to extend the range of a document holder or lamp pivoting on a 1/2" diameter rod;
 Capacity: 20 lb.

Product # **Width** **Color**
 WM69-12 12" Black

Document Holder with Arm

WM70

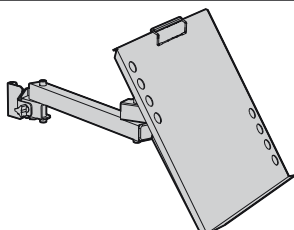

Includes a WM68 light-duty arm adaptor and a 12" WM69 light-duty arm;
 The document holder (14" x 13 1/2") features a paper clip and edge on which to rest binders;
 Capacity: 20 lb.

Product # **Color**
 WM70-01 Black



Components - Structure Above the Work Surface

Computer Supports for Multi-Purpose Frames

Standard Monitor Tray

WM62 / WM64

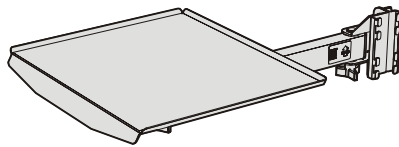

May be used to hold a computer monitor, laptop computer, electronic device or any other object;

Usable tray space: 16" W x 13 7/8" D;

Includes one 18" heavy-duty arm with single or double articulation and a non-slip rubber mat;

The double articulated model allows for increased adjusting possibilities;

Compatible with the WM63 keyboard and mouse tray;

50 lb capacity (wall mounted version: the wall and wall anchoring must be strong enough);

Color: Black;

Wall anchoring not included for the wall mounted model.

Product #	Articulating Arm	Model
WM62-01A	Single	For WM11 frame
WM62-02A	Double	For WM11 frame
WM64-01A	Single	Wall mounted
WM64-02A	Double	Wall mounted



Keyboard and Mouse Tray

WM63

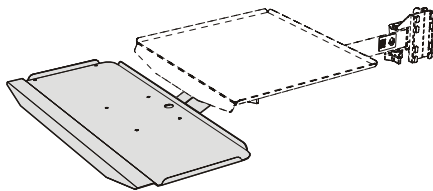

Installs on the WM62 and WM64 monitor tray with arm;

Color: Black;

Usable tray space: 23 11/16" W x 8 1/2" D.

Product #

WM63-2402



LCD Monitor Holder

WM65 / WM66

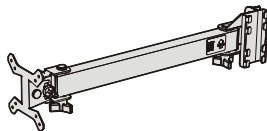

Can be used to hold the majority of LCD monitors on the market;

Screen anchor support respects VESA 75 & 100 standards;

Possible to tilt the screen;

Color: Black;

Note: Not compatible with the keyboard tray.

Product #	Articulating Arm	Model
WM65-01A	Single	For WM11 frame
WM65-02A	Double	For WM11 frame
WM66-01A	Single	Wall mounted
WM66-02A	Double	Wall mounted



LCD Monitor and Keyboard Holder

WM65 / WM66

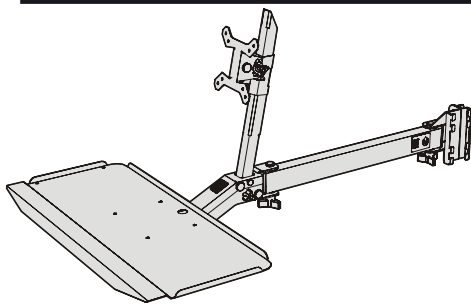

Can be used to hold the majority of LCD monitors on the market;

Screen anchor support respects VESA 75 & 100 standards;

Includes a keyboard holder, usable surface is 23 11/16" W x 8 1/2" D;

Color: Black;

Screen can be adjusted in height, and can also be tilted.

Product #	Articulating Arm	Model
WM65-01B	Single	For WM11 frame
WM65-02B	Double	For WM11 frame
WM66-01B	Single	Wall mounted
WM66-02B	Double	Wall mounted

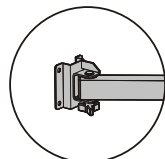

Wall Mounted

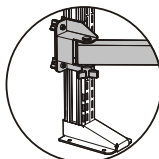

For WM11 Frame

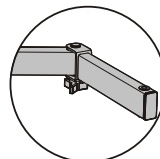

Double Articulating Arm

Components – Structure Above the Work Surface

Privacy Panel and Perforated Panel

WM52 / WM53

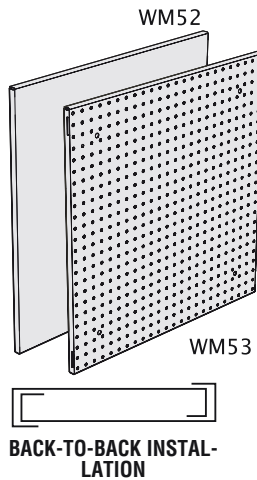

Painted steel WM52;
Used to close the multi-purpose frame at the back;

Painted steel perforated every 1" c/c WM53;
Used to hang accessories or tools.

WM50 panel bracket kit must be ordered separately (1 kit per panel or for 2 back-to-back panels);

If needed, two panels may be fitted together for workstations placed back-to-back;

-24" H panel may be installed on 36" H and 48" H uprights
-36" H panel must be installed on 48" H uprights only

Product #	W x H
WM52-2424	24" x 24"
WM52-2436	24" x 36"
WM53-2424	24" x 24"
WM53-2436	24" x 36"



WORK CENTER

Vinyl Rub-on Identification Decal

WM91



Allows you to easily identify where tools are to be positioned on the perforated panels;

The contrasting color provides fast retrieval and shows if tools are missing, and which ones;

Efficient help for 5S management;

Sold in rolls 2 feet wide and 8 feet long.

Product #
WM91-01J

Panel Bracket Kit



WM50

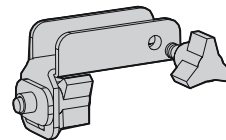

Includes 4 brackets;

Required for installation of WM52, WM53 and WM54 panels;

Easy assembly on WM10 upright sides, no tools required.

Product # **Color**
WM50-01 Black

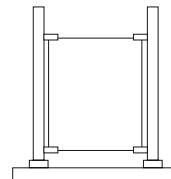

Multiple Tool Holder

WM94

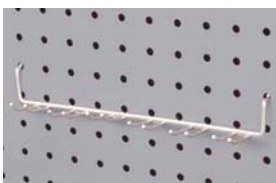

Used for WM51, WM53 and WM56 perforated panels to hang accessories or tools.

Product # **W x H**
WM94-01 9" x 1 1/2"

Screwdriver Holder

WM95



Used for WM51, WM53 and WM56 perforated panels to hang screwdrivers;

May store up to 6 screwdrivers.

Product # **W x D x H**
WM95-01 9" x 1 1/2" x 1 3/4"

Straight Arm Hooks

WM96



Used for WM51, WM53 and WM56 perforated panels to hang accessories or tools;

Sold in packs of 20.

Product # **Depth**
WM96-150 1 1/2"

Single Loop Hooks

WM97



Used for WM51, WM53 and WM56 perforated panels to hang accessories or tools;

Sold in packs of 20.

Product # **Diameter**
WM97-150 1 1/2"
WM97-200 2"

Double Back Single and Double Hooks WM98 / WM99



Used for WM51, WM53 and WM56 perforated panels to hang accessories or tools;

Sold in packs of 10.

Product #	Depth	Type
WM98-03	3"	Single
WM98-05	5"	Single
WM99-03	3"	Double
WM99-05	5"	Double

NOTE

Compatible with perforated panels with 1/4" holes at every 1" c/c. These panels are among the most popular on the market.

Components – Structure Above the Work Surface

WORK CENTER

Tackboard and Marker Panel

WM54

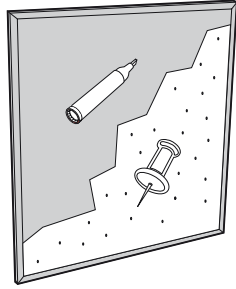

Dual-function reversible panel: tack notes to a cork board and write on a white steel surface using erasable felt-tip markers;

WM50 panel bracket kit must be ordered separately.

Product #	W x H
WM54-2424	24" x 24"

Louvered Panel

WM55

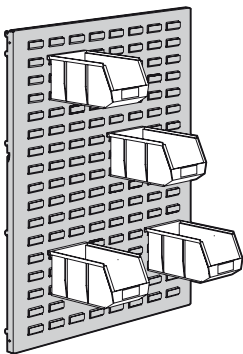

Painted steel;

Used to hang RG20 plastic bins;

Can be used for all brands of plastic bins with hanger lip sold on the market;

Hooks onto WM10 uprights.

Product #	W x H	Uprights
WM55-2824	28" x 24"	36" to 48"
WM55-2836	28" x 36"	48"



Vertical Adaptor for Electrical and Air Outlets



WM41

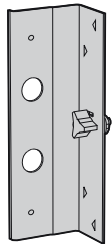

Installs on the side of WM10 upright;

Can receive a power outlet strip or pneumatic connector.

Product #	Height	Color
WM41-01	8"	Black

Panel Bracket Kit



WM50

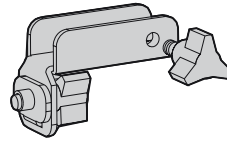

Includes 4 brackets;

Required for installation of WM52, WM53 and WM54 panels;

Easy assembly on WM10 upright sides, no tools required.

Product #	Color
WM50-01	Black

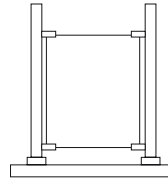

Power Outlet Strip

70000500 / 70000505



15A strip equipped with breakers and 6' extension cord;

Requires WM41 adaptor.

Product #	Length	No. of outlets
70000500	9"	5 without on / off switch
70000505	12"	6 with on / off switch

Power Outlet Channel

WM40

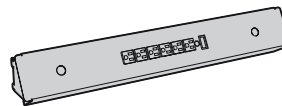

Hooks easily onto WM10 uprights;

Includes 6 outlets (15A or 20A) with interrupter, breaker and 2 knockouts for pneumatic fittings;

Order by adding 01 to the product # for a 15A power strip or 03 for a 20A power strip.

Product #	Width
WM40-28	28"

NOTE If you order the 20A version, ensure that your building has 20A circuits with the special outlets required.

Components – Structure Above the Work Surface

Lamp with Double Fluorescent Light

70000625



Attaches on work surface or on WM10 uprights with a WM68-01 light-duty arm adaptor, sold separately;
The lamp's reach on the upright may be lengthened with a WM69-12 light-duty arm, sold separately;
Color: Black;
Fluorescent tubes included.

Product #
70000625

Overhead Workstation Light

WM45

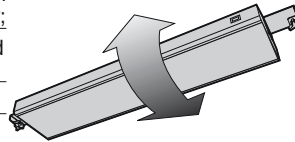

Installs on WM18 cantilever overhead supports (must be ordered separately);
2 fluorescent tubes (T8) included;
Lighting directed downward; no blinding effects;
Installation on single or double unit frames;
Attachments allow the light fixture to pivot and adjust front to back;
Includes one K12 acrylic louver, 10' extension cord and an on/off switch.

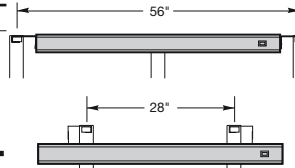

Product #	Width	Color	Ballast
WM45-48T8	48"	Black	Electronic

Lamp with Magnifier and Fluorescent Light

70000635



Attaches on work surface or on WM10 uprights with a WM68-01 light-duty arm adaptor, sold separately;
The lamp's reach on the upright may be lengthened with a WM69-12 light-duty arm, sold separately;
Dioptric grade: 3 (magnification: 1.75X);
Color: Black;
Fluorescent tube included.

Product #
70000635

Parabolic Louver (1/2" x 1/2")

WM46

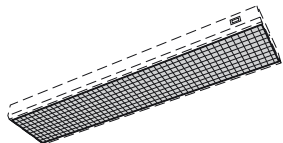

Option for WM45 overhead workstation light to reduce light reflection on a computer screen.

Product #	Width
WM46-4801	48"



Storage Cabinets

Storage Cabinet

WM75

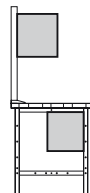
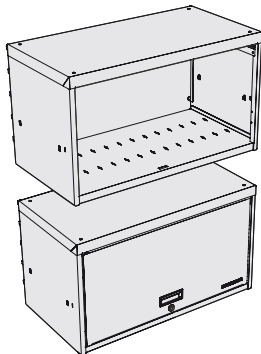

Clips onto WM10 uprights or may be hung under the work surface;

May be secured to the uprights with tapping screws;

The storage cabinet may be subdivided with a WM20-2812 shelf and SH52-1206 partial dividers, as needed;

Capacity: 200 lb.

Product #	W x D x H
WM75-281516	28" x 15" x 16"
WM75-281516L3	28" x 15" x 16" With door and lock (2 keys)



POSSIBLE CONFIGURATIONS



NOTE Shelf and dividers sold separately.



Components - Structure Above the Work Surface

WORK CENTER

Wall Cabinet

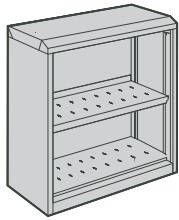

Can be anchored to a wall or installed on a WM11 structure (27", 30" and 36" W) with the RD08 adaptors for WM unit frame;

Bottom shelf included;

Adjustable shelf included with 30" H cabinet;

SH52 dividers can be installed on the shelves;

Wall anchoring not included;

Choice of doors, complete the part # with:

00: Without doors

01: Solid integrated door (except the R5MEA-18 __)

02: Glass single integrated door (for 24" H housings and over)

03: Solid double integrated doors (for 24" H housings and over, 30" W and over)

04: Glass double integrated doors (for 24" H housings and over, 30" W and over)

11: Flipper door (for 18" H housings only)

Height	Width x Depth			
	24" x 14"	27" x 14"	30" x 14"	36" x 14"
18"	R5MCA-18__	R5MPA-18__	R5MDA-18__	R5MEA-18__
24"	R5MCA-24__	R5MPA-24__	R5MDA-24__	R5MEA-24__
30"	R5MCA-30__	R5MPA-30__	R5MDA-30__	R5MEA-30__

Adaptors for RD00 Cabinet

RD08

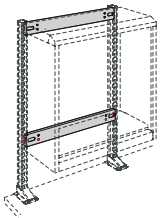

For attaching wall cabinet 27", 30" and 36" W to WM11 unit frame (2 WM10 uprights and WM15 cross member);

Not compatible with the wall cabinet housing RD00 24" W;

Easy to install.

Product #	Width
RD08-28	28"

Adjustable Shelf

RD05

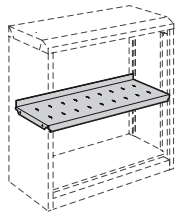

Equipped with back stop to prevent objects from falling into bottom of cabinet;

Adjustable every 1" c/c;

Can hold up to 100 lb, evenly distributed;

Compatible with SH52 dividers.

Product #	W x D
RD05-2412	24" x 12"
RD05-2712	27" x 12"
RD05-3012	30" x 12"
RD05-3612	36" x 12"

Lighting Fixture for Wall Cabinet

RD09

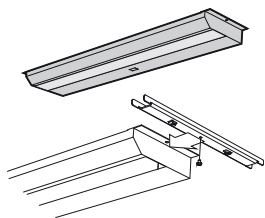

Eliminates shaded areas beneath wall cabinet;

T8 fluorescent tube included;

Includes acrylic outlet, 10' power cord and switch;

Color: Black;

Available widths: 36" and 48";

T8 ballast as energy saver.

Product #	Color
RD09-36T8	Black
RD09-48T8	Black

Wall Cabinet Housing

RD00

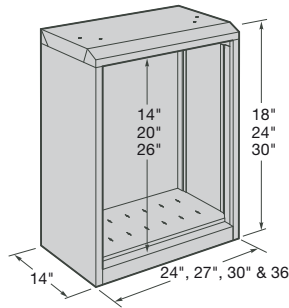

Specifically designed to be anchored to a wall or attached to the WM11 structure (27", 30" and 36" W) with the RD08 adaptors for WM unit frame;

Bottom shelf included;

Shelves, adjustable every 1" c/c, can be installed;

Capacity: 600 lbs, wall and wall anchoring must be strong enough;

Wall anchoring not included.

Cabinet heights available: 18", 24" and 30";

Adaptors for cabinet RD08 must be ordered to fix the wall cabinet 27", 30" and 36" W attached to the WM11

Order by adding the cabinet height to the number. Ex: RD00-241418.

Product #	W x D
RD00-2414__	24" x 14"
RD00-2714__	27" x 14"
RD00-3014__	30" x 14"
RD00-3614__	36" x 14"

Single Integrated Door, Solid and Glass RD10 / RD11

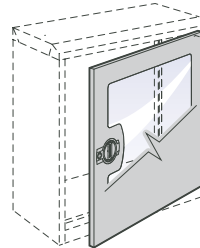

Solid integrated door: RD10;

Glass integrated door: RD11;

Compatible with RD05 adjustable shelves;

Opens 180° to allow full access to stored items;

Standard lock included;

Door widths available: 24", 27", 30" and 36";

Order by specifying the door type, as well as the door width. Ex: RD10-2414L3.

Product #	Height	
RD10- 14L3	14"	Except 36"
RD _ - 20L3	20"	
RD _ - 26L3	26"	



Double Integrated Doors, Solid and Glass RD15 / RD16

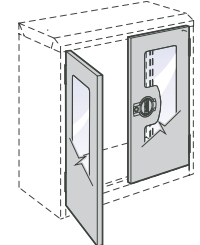

Solid double integrated doors: RD15

Glass double integrated doors: RD16

Compatible with RD05 adjustable shelves;

Open 180° to allow full access to stored items;

Standard lock included;

Order by specifying the type of door. Ex.: RD15-3020L3.

Product #	W x H
RD _ -3020L3	30" x 20"
RD _ -3026L3	30" x 26"
RD _ -3620L3	36" x 20"
RD _ -3626L3	36" x 26"



Flipper Door

RD20

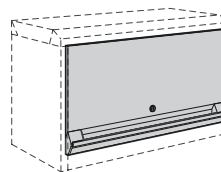

Full width handle for easy, comfortable operation;

Standard lock included;

To order econo lock-in mechanism, complete part # with B;

Compatible with RD05 adjustable shelves (must be factory installed);

For 18" H cabinet housings only.

Product #	W x H
RD20-2414L3	24" x 14"
RD20-2714L3	27" x 14"
RD20-3014L3	30" x 14"
RD20-3614L3	36" x 14"



Components – Specialized Structure for Technicians

The specialized structure for technicians allows you to store a multitude of accessories, from the simplest of tools to a computer with LCD monitor, while being very easy to access.

The component layout is easy to change with a minimum number of tools. You can easily change and expand your structure according to your needs. In addition, our products set themselves apart by their superior quality, design and attention to detail. All screws are hidden from view, making the overall look very appealing.



R5XHG-4005

WORK CENTER

Tech Upright

RD44



Used for installing a storage cabinet (RD02), Smart computer cabinet (R5MCA), panel supports (RC47) and power or cover panels (RC60/RC61/RC62/RC63);

Solid anchor system to the top of the work surface.

Product

RD44-40

Power Feed Panel

RC60 / RC61



Painted steel: RC60;

Stainless steel: RC61;

Can be combined with a cover panel when required, or used on its own to cover the foot of the tech upright – used to achieve a polished look;

Includes a 6 outlet power bar (15A or 20A), a perforation for air connection and a perforation for a telephone or network jack (covered with a finishing plate);

Available for applications with tech uprights (RD44).

Product #	Width	Amp.
RC_-3001	30"	15A
RC_-3003	30"	20A
RC_-3601	36"	15A
RC_-3603	36"	20A
RC_-4801	48"	15A
RC_-4803	48"	20A

NOTE

If your order the 20A version, ensure that your building has 20A circuits with the special outlets required.

Panel supports

RC47



Used to install finishing panels (RC41/RC42), perforated panels (RC43/RC44) and louvered panels (RC45);

Allows user to install different combinations of panels;

Supports for the lower section 01. Must be ordered when installing two finishing panels, one above the other, or a finishing panel with the RD02 storage cabinet;

Supports for the upper section 02. Must be ordered when installing two finishing panels, one above the other, to create a full-height wall only;

When ordering a support for the lower section add 01 to the end of the number, for the upper section add 02.

Product #	Width
RC47-24_	24"
RC47-30_	30"
RC47-36_	36"
RC47-48_	48"

Cover Panel

RC62 / RC63



Painted steel: RC62;

Stainless steel: RC63;

Can be combined with a power feed panel when required, or used on its own to cover the foot of the tech support – used to achieve a polished look;

Available for application with tech uprights (RD44).

Product #	Width
RC_-2401	24"
RC_-3001	30"
RC_-3601	36"
RC_-4801	48"

Finishing Panel

RC41 / RC42

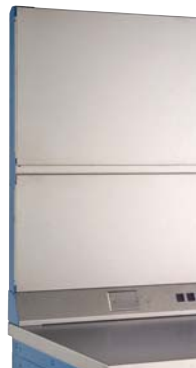

Painted steel: RC41;

Stainless steel: RC42;

Provides an impeccable finish;

Upper panel can be replaced with a cabinet (RD02);

Stacking two panels (15" + 20") is possible in order to achieve a full height wall;

Lower finishing panel = 15;

Upper finishing panel = 20;

When ordering a finishing panel for the lower section add 15 to the end of the number, for the upper section add 20.

Product #	Width
RC_-24_	24"
RC_-30_	30"
RC_-36_	36"

Components – Specialized Structure for Technicians

WORK CENTER

Perforated Panel

RC43 / RC44



Painted steel: RC43;
Stainless steel: RC44;
Perforated at every 1" C/C, the panel is compatible with all of the WM9_ hooks (see pages 66 or 119);
Upper panel can be replaced with the RD02 cabinet;
Stacking two panels (15" + 20") is possible in order to achieve a full height wall;
Lower perforated panel = 15;
Upper perforated panel = 20;
When ordering a perforated panel for the lower section add 15 to the end of the number, for the upper perforated panel add 20.

Product #	Width
RC_-24_	24"
RC_-30_	30"
RC_-36_	36"

Louvered Panel

RC45



Offered in painted steel only;
Compatible with RG20 plastic bins and any other type of plastic bin with hanging lip on the market;
Upper panel can be replaced with the RD02 cabinet;
Stacking two panels (15" + 20") is possible in order to achieve a full height wall;
Lower louvered panel = 15;
Upper louvered panel = 20
When ordering a louvered panel for the lower section add 15 to the end of the number, for the upper louvered panel add 20.

Product #	Width
RC45-24_	24"
RC45-30_	30"
RC45-36_	36"

Smart Computer Cabinet



Cabinet dimensions: 24" W x 14" D x 21" H;
Glass surface dimensions: 18 7/8" W x 14 1/8" H;
Useable support surface: 22 1/2" W x 14 1/2" D.

Product #	Type
R5MCA-2450	Wall-mounted cabinet only
R5MCA-2451	Wall-mounted cabinet with glass door
R5MCA-2452	Wall-mounted cabinet with keyboard and mouse support
R5MCA-2453	Wall-mounted cabinet with glass door and keyboard and mouse support
R5MCA-2454	Wall-mounted cabinet with flipper door and laptop support



Storage Cabinet

RD02



Can be used in a wall mount application as well as with the RD44 tech uprights;
The back is detachable for wall mount application which allows for easy access to wall outlets, etc;
Offers with RD20 flipper door with comfortable full width handle;
Compatible with the lighting fixture (RD09) and LED light (RD07);
Standard lock included.



Product #	W x D x H
R5MCB-2111	24" x 14" x 21"
R5MDB-2111	30" x 14" x 21"
R5MEB-2111	36" x 14" x 21"
R5MGB-2111	48" x 14" x 21"

Lighting Fixture

RD09



Eliminates shaded areas beneath upper cabinet;
T8 fluorescent tube included;
Includes acrylic outlet, 10' power cord and switch;
Color: Black;
Available width: 36" and 48";
T8 ballast as energy saver.

Product #	Width
RD09-36T8	36"
RD09-48T8	48"

Adaptor for LED Light



RD06



Using for installing LED light RD07;
Designed to maximize the modularity of the LED light;
Color: Black;
To order, choose the product # according to the storage cabinet dimensions (RD02).

Product #	Storage cabinet dimension
RD06-24	24"
RD06-30	30"
RD06-36	36"
RD06-48	48"

LED Light



RD07



Light equipped with magnet for assembly directly underneath any metal surface;
Can also be installed under RD02 storage cabinet using RD06 adaptors;
Each unit is equipped with LED strips;
Casts brighter light than florescent tubes and is energy efficient;
Equipped with a 60 Watt power supply;
Equipped with a cord 40" long to plug the supply;
The first LED module connected to the power supply controls the light.

Product #	Lit surface area
RD07-024-01	24"
RD07-036-01	36"
RD07-048-01	48"
RD07-060-01	60"
RD07-072-01	72"

NOTE Not compatible with smart computer cabinet and lighting fixture RD09.

Proposals - Specialized Word Center

Whether you need a workstation combined with high density storage (drawers in shelving and modular cabinets), bulk storage (industrial shelving and Mini-racking) or specialized storage (ex.: for numerically controlled tools), Rousseau has the flexibility you're looking for. Our vast selection of accessories means endless possibilities.

Storage Unit with Work Surface

R5WL3-2003



R5WL3-2003

4 universal posts	SR10-087
2 universal posts	SR10-039
2 pairs of medium-duty beams	SR21-72
6 box shelves	SH20-3624
6 Mini-racking steel decking	SR40-2424
2 medium-duty tie bars	SR25-24
2 front bases	SH28-36
1 pair Mini-racking ladder braces	SR30-24
3 side panels	SH30-2439

Product #	W x D x H
R5WL3-2003	72" x 24" x 87"

2 back panels	SH31-3639
1 set Rousseau Spider® mounting brackets	RE30-34
4 heavy-duty drawers	RF32-362404
3 heavy-duty drawers	RF32-362406
6 floor anchor plates	SH45
1 floor anchor hardware kit	SH47-02
1 floor anchor hardware kit	SH47-04
1 laminated wood top	SR90-7224A

This model was created with products from the "Spider® Shelving System" section.

SEE PAGES 56-77

WORK CENTER

Multi-Functional Workstation for CNC Tools

NCS8003



NCS8003

4 closed welded uprights	SH12-24087
10 box shelves	SH20-3024
2 front bases	SH28-30
8 floor anchor plates	SH45
2 floor anchoring hardware kits	SH47-04
2 back panels	SH31-3039
2 back panels	SH31-3051
8 painted shelf dividers	SH50-2412
3 CNC adaptors for Spider® shelving	NC51-2401
1 side louvered panel	SH66-2415
1 laminated wood top, 90° radius front edge	SR90-6024A
1 pair of top supports	SH74-24
1 single WM unit frame	WM11-2848
1 -12" power outlet strip	70000505
1 adaptor for outlet strip	WM41-01
1 perforated panel	WM53-2436

Product #	W x D x H
NCS8003	130" x 24" x 87"

1 panel bracket kit	WM50-01
1 double back single hooks (packs of 10)	WM98-03
1 adaptor for WM uprights	NC50-2801
1 overhead workstation light	WM45-48T8
1 pair cantilever overhead supports	WM18-26
1 set Rousseau Spider® mounting brackets	RE30-34
1 heavy-duty drawer	RF32-302403
2 heavy-duty drawers	RF32-302404
2 heavy-duty drawers	RF32-302407
1 heavy-duty drawer	RF32-302409

This model was created with products from the "Spider® Shelving System", "Workstation" and "CNC Tool Storage" sections.

SEE PAGES 56-77 86-131 172-181

NOTE Tool racks must be ordered separately.

SEE PAGE 172

Technical Maintenance Workstation

R5XDG-4001



R5XDG-4001

2 modular cabinets with lock	RA30-302758L3
2 forklift bases	RA52-302702
2 stacking cabinets	R5HDG-2401
8 heavy-duty drawers	RF31-302703
12 heavy-duty drawers	RF31-302706
1 heavy-duty drawer	RF31-302712
1 laminated wood top	WS14-6030A
1 multi-purpose frame	WM11-5648
1 pair cantilever overhead supports	WM18-26
1 overhead workstation light	WM45-48T8
2 wall cabinets	R5MDA-1811
2 adaptors for WM frame	RD08-28
2 steel shelves	WS50-6012

Product #	W x D x H
R5XDG-4001	120" x 27" x 84"

4 side brackets for top	RA73-04
2 adaptors for WS50 shelf	RC15-24
1 panel bracket kit	WM50-01
1 perforated panel	WM53-2436
1 double back single hooks (packs of 10)	WM98-03
2 plastic bin rails	WM28-2801
4 plastic bins	RG20-060603
4 plastic bins	RG20-060303
1 power outlet channel	WM40-2801

This model was created with products from the "Heavy-Duty Modular Cabinet" and "Workstation" sections.

SEE PAGES 4-27 86-131

Multi-Purpose Stand

MULTI-PURPOSE STAND



Wide variety of accessories provide flexibility for custom layouts.



All components are assembled to the uprights with plastic knobs or installed with hooks.



Layout and position of components may be changed without using tools, allowing your system to evolve with your needs.



36" and 54" stands high can be made mobile for added flexibility.



WMA4050

MULTI-PURPOSE STAND

The multi-purpose stand allows you to keep a multitude of accessories close at hand, from the simplest tools to complex computer parts, spools supports and electronic equipment.

Both the centered and off-center stands give you fast access to each and every item you're storing. In addition to the stationary stands, available in 36", 54" and 84" high, Rousseau also offers a 36" and 54" high mobile version.

The accessory layout on the Rousseau multi-purpose stand is easily changed, without tools. Modify the stand according to your evolving needs by simply adding and moving the accessories.

Storekeeper Model



WMA1012

Makes transporting small items easy.

1 – 54" high centered WM stand	
8 plastic bin rails	WM28-2801
1 document holder	WM90-01
1 bottom shelf with rubber mat	WM83-282701

Product #	W x D x H
WMA101	32" x 27" x 59 1/4"



WMA1052

Facilitates workstation and assembly line tasks.

1 – 54" high centered WM stand	
2 tiltable shelves	WM20-2812
6 partial dividers	SH52-1206
1 bottom shelf with rubber mat	WM83-282701
2 tiltable pans	WM22-2820

Product #	W x D x H
WMA105	32" x 27" x 59 1/4"



NOTE Any and all accessories not mentioned in the description are not sold by Rousseau.

Wire Spool Model



WMA1032

Facilitates storing of and access to wire spools.

1 – 54" high centered WM stand	
1 bottom shelf with rubber mat	WM83-282701
8 wire spool supports	WM31-2801

Product #	W x D x H
WMA103	32" x 27" x 59 1/4"

NOTE Any and all accessories not mentioned in the description are not sold by Rousseau.



ATTENTION

TO ORDER: Model numbers must be completed according to the selected option.

Stationary models:

- 0 with floor anchoring kit
- 1 with leveling glide kit

Mobile models (54" high stands only):

- 2 with handle and 4" casters: 2 rigid and 2 swivel with total-lock brake system
- 3 with handle and 4" casters: 2 swivel and 2 swivel with total-lock brake system
- 4 with handle and 6" casters: 2 rigid and 2 swivel with total-lock brake system
- 5 with handle and 6" casters: 2 swivel and 2 swivel with total-lock brake system

Proposals

MULTI-PURPOSE STAND

Labeling Model

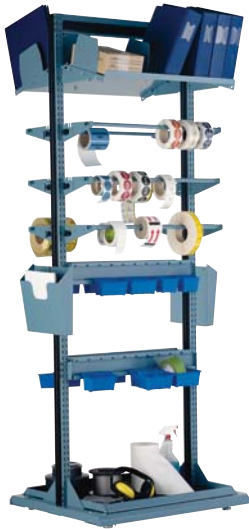

WMA3021

The perfect solution for all of your labeling needs.

- 1 – 84" high centered WM stand
- 2 tiltable shelves WM20-2812
- 6 partial dividers SH52-1206
- 4 plastic bin rails WM28-2801
- 6 wire spool supports WM31-2801
- 2 document holders WM90-01
- 1 bottom shelf WM83-282701

Product #	W x D x H
WMA302	32" x 27" x 85"

Repair and Maintenance Model



WMA3031

For repair or maintenance tasks on workstations installed back-to-back.

- 1 – 84" high centered WM stand
- 2 cantilever overhead supports WM18-26
- 2 overhead workstation lights WM45-48T8
- 2 tiltable shelves WM20-2812
- 6 partial dividers SH52-1206
- 2 perforated panels WM53-2424
- 1 panel bracket kit WM50-01
- 2 packs of 10 double back single hooks WM98-03
- 2 wire spool supports WM31-2801
- 2 vertical adaptors for electrical and air outlets WM41-01
- 2 power outlet strips 70000505
- 2 document holders with arm WM70-01

Product #	W x D x H
WMA303	32" x 27" x 85"

NOTE Any and all accessories not mentioned in the description are not sold by Rousseau.

Electronic Model



WMA4041

Our proposal to organize and protect the equipment in an electronic workstation.

- 1 – 84" high off-center WM stand
- 1 cantilever overhead support WM18-26
- 1 overhead workstation light WM45-48T8
- 1 plastic bin rail WM28-2801
- 1 storage cabinet with door and lock WM75-281516L3
- 6 partial dividers SH52-1206
- 1 tiltable pan WM22-2820
- 1 vertical adaptor for electrical and air outlets WM41-01
- 1 power outlet strip 70000505
- 1 lamp with magnifier and fluorescent light 70000635
- 1 light-duty arm adaptor WM68-01

Product #	W x D x H
WMA404	32" x 27" x 85"

Computer Model



WMA4021

Complete workstation with all the space you need for your computer components.

- 1 – 84" high off-centered WM stand
- 2 tiltable shelves WM20-2812
- 6 partial dividers SH52-1206
- 1 bottom shelf WM83-282702
- 1 tiltable pan WM22-2820
- 1 document holder with arm WM70-01
- 1 vertical adaptor for electrical and air outlets WM41-01
- 1 power outlet strip 70000505

Product #	W x D x H
WMA402	32" x 27" x 85"

NOTE Any and all accessories not mentioned in the description are not sold by Rousseau.

ATTENTION

TO ORDER: Model numbers must be completed according to the selected option.

Stationary models:

- Q with floor anchoring kit
- 1 with leveling glide kit



Multi-Purpose Stand Stability and Capacity

LEGEND

Workstation stability is safe.

This configuration is not recommended.

54" STANDS

84" STANDS

Maximum capacity: 1200 lb, evenly distributed load.

Maximum capacity: 700 lb load distributed on one or both sides.

Multi-Purpose Stand

WMA

Stand offered in three heights: 36", 54" and 84";
Centered and off-center stands available;
Post offers up to 6 fixing zones for a minimum of interference between components.

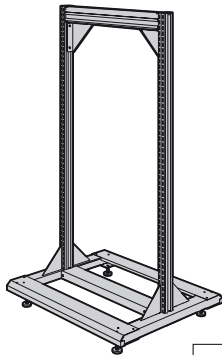

Product #	Height	Type
WMA500	36"	Centered
WMA600	36"	Off-center
WMA100	54"	Centered
WMA200	54"	Off-center
WMA300	84"	Centered
WMA400	84"	Off-center

NOTE 54" mobile stand includes handle.

ATTENTION TO ORDER:
Model numbers must be completed according to the selected option.

Stationary models:
0 with floor anchoring kit
1 with leveling glide kit

Mobile models (36" and 54" high stands only):
2 with 4" casters: 2 rigid and 2 swivel with total-lock brake system
3 with 4" casters: 2 swivel and 2 swivel with total-lock brake system
4 with 6" casters: 2 rigid and 2 swivel with total-lock brake system
5 with 6" casters: 2 swivel and 2 swivel with total-lock brake system

Replacement Handle

WS74

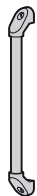

Aluminum with black plastic end caps;
Installs on the side of the multi-purpose stand;
Modern, attractive look;
Included with 54" H mobile models.

Product #
WS74-01

4" and 6" Casters

LB81 / LB84

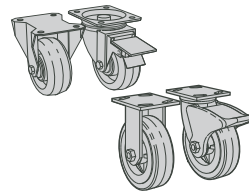

Choice of 3 types of casters: rigid, swivel, swivel with total brake (on wheel and swivel);
4" casters: 420 lb; capacity; 5 1/4" high;
6" casters: 900 lb; capacity; 7 1/2" high;
Heavy-duty, non-marking polyurethane casters; superior quality industrial casters;
Included with 36" H and 54" H mobile multi-purpose stands.

Shelf for WM Upright

WM84

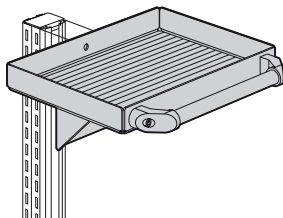

Usable shelf area: 8" x 14" x 1";
Horizontal aluminum handle with plastic end caps available for 36" high mobile stands only.

Product #	Description
WM84-081401	With handle for 36" high mobile stands
WM84-081402	Without handle for 36", 54" and 84" high stands

Document Holder

WM90

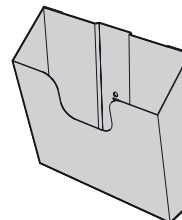

Specially designed to be installed on the multi-purpose stand;
Keeps paperwork or manuals accessible and organized.

Product #
WM90-01

Bottom Shelf

WM83

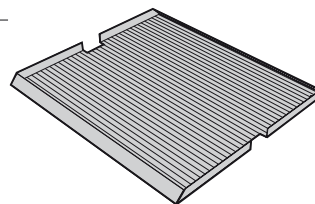

Fastened at the bottom of the multi-purpose stand;
Equipped with heavy-duty rubber mat;
Dimensions: 26" W x 22 3/4" D (inside dim.)

Product #	Structure
WM83-282701	Centered
WM83-282702	Off-center

IMPORTANT

All 28" wide multi-purpose upright accessories are compatible with multi-purpose stands AS LONG AS all security recommendations are followed. For further information, contact your customer service representative.

SEE PAGES 114-122

Ergonomic Seats

ERGONOMIC SEATS

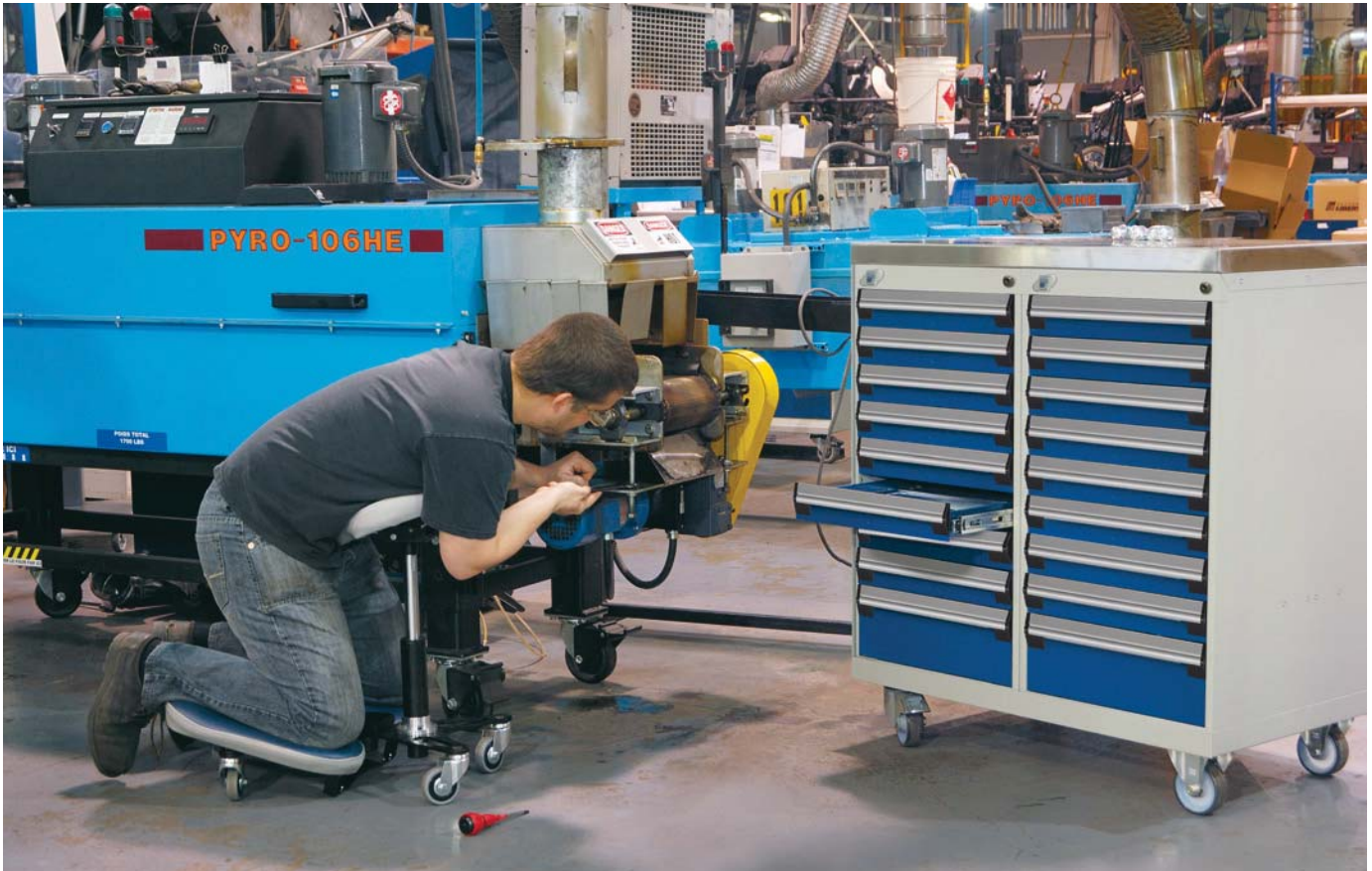

ERGONOMIC SEATS

Our work often obliges us to work in positions that require poor posture. In addition to being uncomfortable, this can cause premature fatigue and increase the risk of injuries.

Here are some statistics directly related to poor posture: "In 2005 in the United States, almost 15% of the 1 234 680 injuries and illnesses with days away from work came from worker motion or position."

Source: Bureau of Labor Statistics, U.S. Department of Labor

Our ergonomic seats improve the worker's comfort and reduce tension and fatigue, therefore reducing the risk of injury.

Our ergonomic seats reduce tension in the:

- Shoulders
- Lumbar region
- Knees
- Ankles

● Pressure points



WS07-01

The ergonomic seats are equipped with high-density cushions covered with durable fabric that is easy to care for. Plus, all the seats are height adjustable allowing, for a comfortable position at all times.

Ergonomic Seats

ERGONOMIC SEATS

STAG4

WS07

TA180

WS07



Provides comfort when workers carry out tasks in prolonged kneeling positions;
 Seat rotates 360° and tilts 20°;
 5 industrial casters;
 Seat dimensions: 12 1/2" x 12";
 Adjustable height range of 17 3/4" to 23 1/2";
 Comes with a tool compartment;
 Color: blue with gray border.

Product #	W x D x H
WS07-01	19 3/4" x 27 1/4" x 17 3/4" to 23 1/2"



Seat tilts 5°;
 Improves comfort when working on raised surfaces;
 Reduces foot and leg pain due to prolonged standing position;
 Adjustable height range of 25 1/2" to 35 1/4";
 Optimizes freedom of movement;
 Seat dimensions: 9 3/4" x 11 3/8";
 Color: blue with gray border.

Product #	W x D x H
WS07-05	16 1/2" x 21" x 25 1/2" to 35 1/4"



VEGA

WS07

TF160

WS07



Helps to reduce pressure in the lumbar region, shoulders and ankles;
 Seat rotates 360°;
 5 industrial casters;
 Seat dimensions: 19" x 25";
 Adjustable height range of 18 3/4" to 23 1/2";
 Color: blue with gray border.

Product #	W x D x H
WS07-03	28" x 28" x 35" to 46 1/2"



Improves comfort when working on raised surfaces;
 Seat rotates 360°;
 5 industrial casters;
 Seat dimensions: 19" x 15";
 Adjustable height range of 24" to 34";
 Color: blue with gray border.

Product #	W x D x H
WS07-04	28" x 28" x 34 1/2" to 46 1/2"

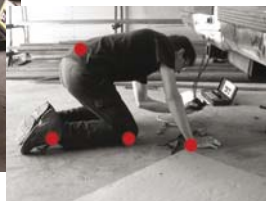

Modular Drawer

MODULAR DRAWER



THE ROUSSEAU DRAWER : FIRST TO THE FINISH LINE

The sturdiest and the most durable on the market

Tested in an independent laboratory, the Rousseau drawer proved its superiority on many levels: loaded to its full capacity, the Rousseau drawer completed a high level of cycles, without showing any signs of wear. The Rousseau drawer has become the champion of its category.

Its performance can be defined in terms of its durability. The Rousseau drawer's sturdy construction offers superior output while having a much longer lifespan. This is why Rousseau doesn't even hesitate to offer a Life-time Warranty on the drawer rolling mechanism. An undeniable advantage!



A multitude of accessories

The Rousseau drawer makes your work easy: The vast array of accessories offered, all of which are compatible with each other, contribute to maximizing the organization of your work space. In addition, all of these accessories can be easily rearranged according to your needs, making them a joy to use and displaying just how highly functional they are.



Streamlined design

In addition to being sturdy and functional, the Rousseau drawer has an alluring appearance. It fits just as well in an office as it does in a factory. It allows you to arrange your work space in a harmonious and aesthetic fashion. The unique shape of the "R" drawer is a Rousseau Metal Inc. trademark and we have protected the industrial design of the drawer.

Modular Drawer

MODULAR DRAWER

The Rousseau Advantages



With a capacity of 400 lb, the drawer can be opened thousands of times without showing signs of slowing down.



10 drawer heights and 7 side heights are available.

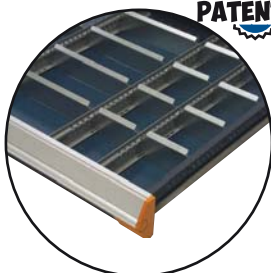

Partitions and dividers are clipped in.



Company name embossed on the face of the drawer. If you don't see ROUSSEAU, it's not a ROUSSEAU.

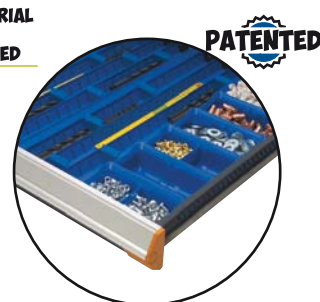

All accessories are compatible with each other.

Details that make the difference

ERGONOMIC

The full-width handle as well as the accessories (Integrated Lock-In mechanism, Lock-Out mechanism, lock, etc.) have been designed down to the smallest detail in order to make your work easier.

EFFICIENT

A multitude of available accessories, such as partitions and dividers, plastic bins, groove trays, foam for tools and hanging file bars allow you to organize your space.

ACCESSIBLE

Drawers open 100%, giving you complete access to the contents.



R5AEE-5825

STURDY

400 lb capacity per drawer.



DURABLE



R5SEE-874803

INGENIOUS

Accessories can be added at all times.

NOTE The unique shape of the "R" drawer is a Rousseau Metal Inc. trademark.

Index	Page(s)
Modular Drawer	132 - 136
Proposals	137 - 150
Accessories	151 - 155

16 drawer sizes x 10 heights = 160 possible dimensions

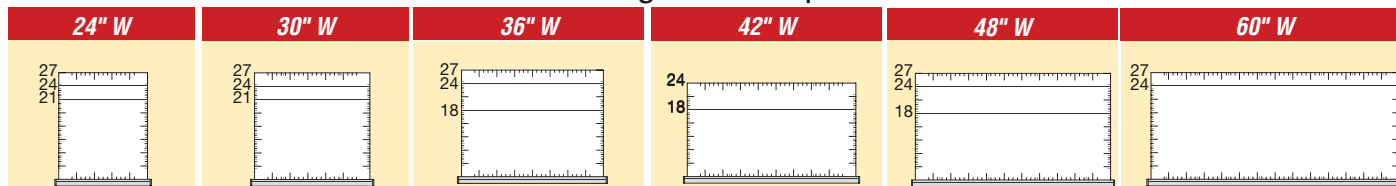

Modular Drawer

Modular Drawers and Roll-Out Shelves

Heavy-Duty Modular Drawer

RF31 / RF32



Drawer for cabinets (and multi-drawer) : RF31;
 Drawers for shelving : RF32;
 400 lb capacity, 100% extension;
 Heavy-duty construction;
 Easy to install;
 Vast choice of accessories offered to adapt to your storage needs;
 Available drawer heights :
 3", 4", 5", 6", 7", 8", 9", 10", 12" and 14";

SEE PAGES 151-155

Order by specifying the type of application (cabinet or shelving) and adding the drawer height to the part #. Ex. : RF31-362406;

SEE PAGES 137-150

For modular drawers with layouts,

Product #	W x D	Product #	W x D
RF_-2421	24" x 21"	RF_-3627	36" x 27"
RF_-2424	24" x 24"	RF_-4218	42" x 18"
RF_-2427	24" x 27"	RF_-4224	42" x 24"
RF_-3021	30" x 21"	RF_-4818	48" x 18"
RF_-3024	30" x 24"	RF_-4824	48" x 24"
RF_-3027	30" x 27"	RF_-4827	48" x 27"
RF_-3618	36" x 18"	RF_-6024	60" x 24"
RF_-3624	36" x 24"	RF_-6027	60" x 27"

Heavy-Duty Front Access Roll-Out Shelf

RF40 / RF41



Roll-out shelf for cabinet (and multi-drawer) : RF40;
 Roll-out shelf for shelving : RF41;
 400 lb capacity, 100% extension;
 Heavy-duty construction;
 Easy to install;
 Painted steel with 3" edges on sides and back;
 Full access to contents;
 Height : 6";

Order by specifying the type of application (cabinet or shelving). Ex. : RF40-3624.

Product #	W x D	Product #	W x D
RF_-2421	24" x 21"	RF_-3627	36" x 27"
RF_-2424	24" x 24"	RF_-4218	42" x 18"
RF_-2427	24" x 27"	RF_-4224	42" x 24"
RF_-3021	30" x 21"	RF_-4818	48" x 18"
RF_-3024	30" x 24"	RF_-4824	48" x 24"
RF_-3027	30" x 27"	RF_-4827	48" x 27"
RF_-3618	36" x 18"	RF_-6024	60" x 24"
RF_-3624	36" x 24"	RF_-6027	60" x 27"

Heavy-Duty 3-Sided Access Roll-Out Shelf

RF44 / RF45



Roll-out shelf, 3-sided access for cabinet (and multi-drawer) : RF44;
 Roll-out shelf, 3-sided access for shelving : RF45;
 400 lb capacity, 100% extension;
 Heavy-duty construction;
 Easy to install;
 Galvanized steel with 1 1/2" edge on back;
 Height : 5";

May serve as work surface;
 Order by specifying the type of application (cabinet or shelving). Ex. : RF44-3624.

Product #	W x D	Product #	W x D
RF_-2421	24" x 21"	RF_-3627	36" x 27"
RF_-2424	24" x 24"	RF_-4218	42" x 18"
RF_-2427	24" x 27"	RF_-4224	42" x 24"
RF_-3021	30" x 21"	RF_-4818	48" x 18"
RF_-3024	30" x 24"	RF_-4824	48" x 24"
RF_-3027	30" x 27"	RF_-4827	48" x 27"
RF_-3618	36" x 18"	RF_-6024	60" x 24"
RF_-3624	36" x 24"	RF_-6027	60" x 27"

Drawer and Roll-Out Shelf Dimensions

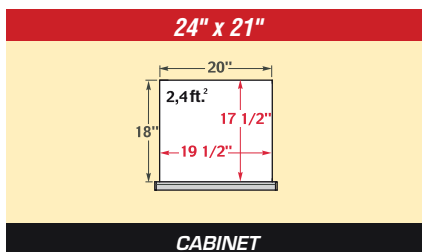
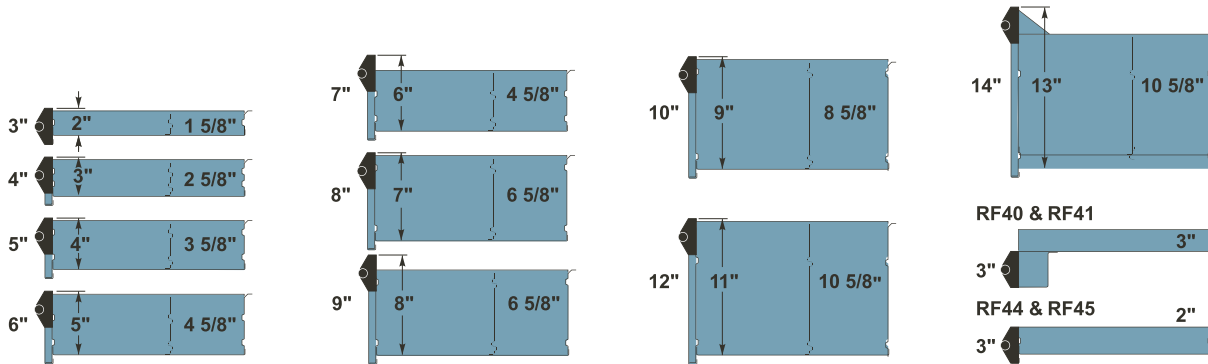

CABINET
 RF31-2421
 RF40-2421
 RF44-2421

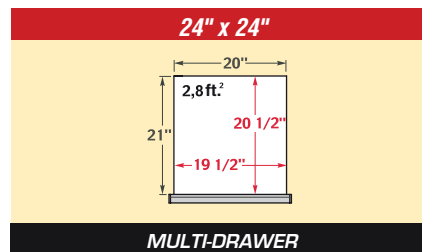

MULTI-DRAWER

SEE PAGES 50-55

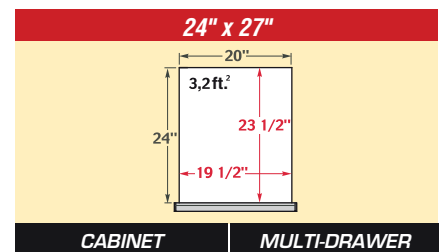

CABINET

RF31-2427
 RF40-2427
 RF44-2427

MULTI-DRAWER

SEE PAGES 50-55

Modular Drawer

MODULAR DRAWER

30" x 21"

CABINET

RF31-3021
RF40-3021
RF44-3021

30" x 24"

SHELVING | **MULTI-DRAWER**

RF32-3024
RF41-3024
RF45-3024

SEE PAGES 50-55

30" x 27"

CABINET | **MULTI-DRAWER**

RF31-3027
RF40-3027
RF44-3027

SEE PAGES 50-55

36" x 18"

CABINET | **SHELVING**

RF31-3618
RF40-3618
RF44-3618

RF32-3618
RF41-3618
RF45-3618

36" x 24"

CABINET | **SHELVING** | **MULTI-DRAWER**

RF31-3624
RF40-3624
RF44-3624

RF32-3624
RF41-3624
RF45-3624

SEE PAGES 50-55

36" x 27"

CABINET | **MULTI-DRAWER**

RF31-3627
RF40-3627
RF44-3627

SEE PAGES 50-55

42" x 18"

SHELVING

RF32-4218
RF41-4218
RF45-4218

42" x 24"

SHELVING

RF32-4224
RF41-4224
RF45-4224

R5ADG-5822

48" x 18"

SHELVING

RF32-4818
RF41-4818
RF45-4818

48" x 24"

CABINET | **SHELVING** | **MULTI-DRAWER**

RF31-4824
RF40-4824
RF44-4824

RF32-4824
RF41-4824
RF45-4824

SEE PAGES 50-55

48" x 27"

CABINET | **MULTI-DRAWER**

RF31-4827
RF40-4827
RF44-4827

SEE PAGES 50-55



60" x 24"

CABINET | **MULTI-DRAWER**

RF31-6024
RF40-6024
RF44-6024

SEE PAGES 50-55

60" x 27"

CABINET | **MULTI-DRAWER**

RF31-6027
RF40-6027
RF44-6027

SEE PAGES 50-55

Modular Drawer

How to Order a Drawer

You can choose a drawer model from among our proposals with layouts :

00 for layout kit only

51 for a drawer in a cabinet, with layout

52 for a drawer in shelving, with layout,

EXAMPLE: **R EE-A0200**

Drawer height

Locking or security mechanism

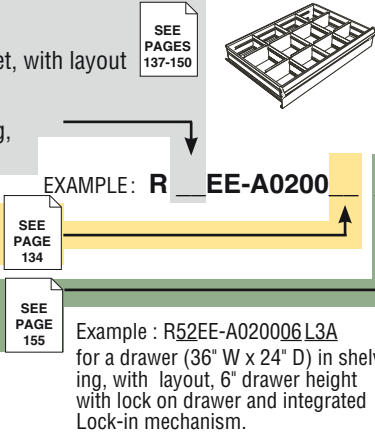

You can create a personalized model by choosing an empty drawer (to which you can add layout accessories) :

31 for a drawer in a cabinet

32 for a drawer in shelving

EXAMPLE: **RF - 3624**

Drawer height

Locking or security mechanism

To add layout accessories, accessories must be ordered separately

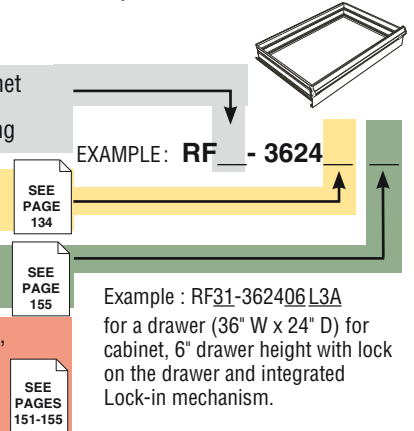

To calculate drawer compartment dimensions, refer to the following illustration.

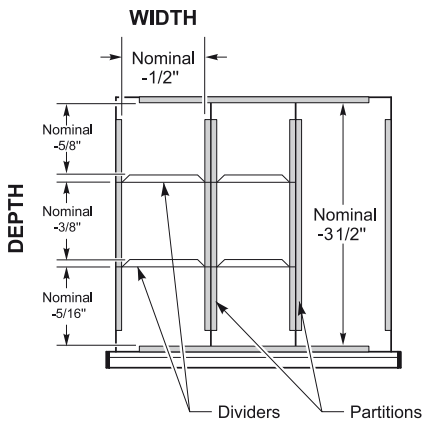

Drawer dimensions

		INSIDE WIDTH					
		20"	26"	32"	38"	44"	56"
OUTSIDE DEPTH	27"	24"x27"	30"x27"	36"x27"	48"x27"	60"x27"	
	24"	24"x24"	30"x24"	36"x24"	42"x24"	48"x24"	60"x24"
INSIDE DEPTH	21"	24"x21"	30"x21"				
	18"			36"x18"	42"x18"	48"x18"	
		24"	30"	36"	42"	48"	60"
		OUTSIDE WIDTH					

How to Order a Roll-Out Shelf

Complete the first portion of the # according to the type of roll-out shelf being ordered :

40 for a roll-out shelf in a cabinet

41 for a roll-out shelf in shelving

44 for roll-out shelf with 3-sided access for cabinet

45 for roll-out shelf with 3-sided access for shelving

EXAMPLE: **RF - 3624**

Locking or security mechanism

SEE PAGE 155

Complete Example : RF41-3624A for a roll-out shelf with 3-sided access for a cabinet, with integrated Lock-In mechanism.



R5XEE-2002

Examples of Available Drawer Interiors

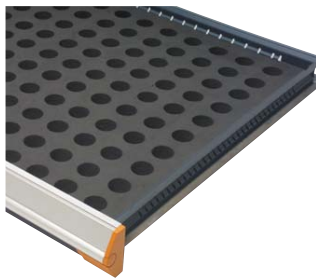

Foam for collets

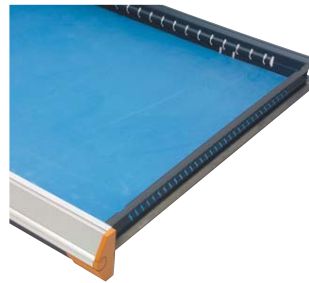

Foam for protection



Foam for tools



Hanging file bars



Groove trays

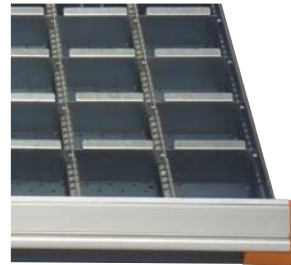

Partitions and dividers

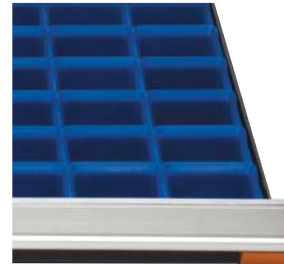

Plastic bins

To order, complete the part number with the drawer height :

00 for compartments only

51 for a drawer in a cabinet, with layout

52 for a drawer in shelving, with layout

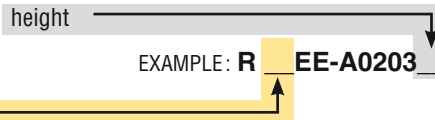

Complete Example : R51CD-A010206
for a drawer with compartments for a 24" W x 21" D cabinet, 6" high.

24" x 21" (W x D) Drawers

For Cabinet

Partitions and Dividers

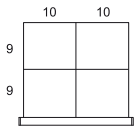

R_CD-A0102
4 compartments

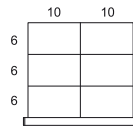

R_CD-A0104
6 compartments

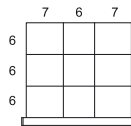

R_CD-A0206
9 compartments

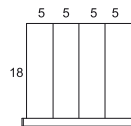

R_CD-A0300
4 compartments

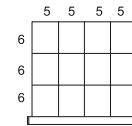

R_CD-A0308
12 compartments

Plastic Bins

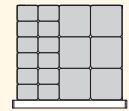

R_CD-E018
18 bins



R_CD-E024
24 bins

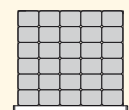

R_CD-E030
30 bins

Groove Trays

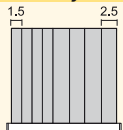

R_CD-G00803
8 groove trays

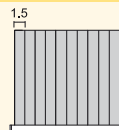

R_CD-G01003
10 groove trays

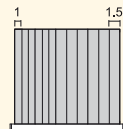

R_CD-G01203
12 groove trays

2 dividers included with each groove tray.

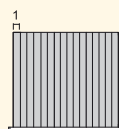

R_CD-G01603
16 groove trays

Foam

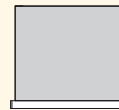

R_CD-J0103
For protection

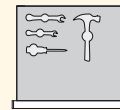

R_CD-J0203
For tools



Sold without cut-outs.
For custom cut-outs,

SEE
PAGE
189

Folder Hanging Bars

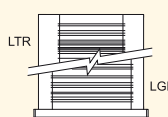

R_CD-KFB12

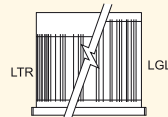

R_CD-KLR12

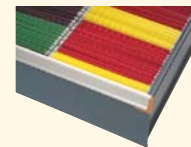

Proposals

24" x 24" (W x D) Drawers

For multi-drawer*

* These proposals include compartments only.

Partitions and Dividers

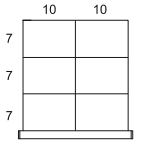

R00CE-A0104
6 compartments

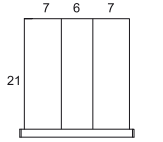

R00CE-A0200
3 compartments

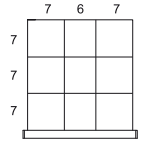

R00CE-A0206
9 compartments

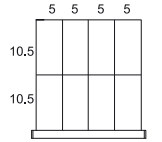

R00CE-A0304
8 compartments

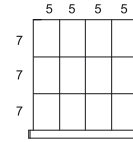

R00CE-A0308
12 compartments

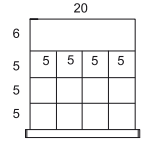

R00CE-C0408
13 compartments

Plastic Bins

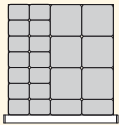

R00CE-E022
22 bins

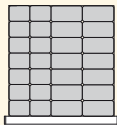

R00CE-E028
28 bins

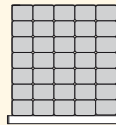

R00CE-E035
35 bins

Foam

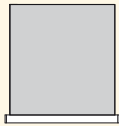

R00CE-J0103
For protection

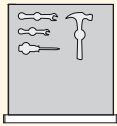

R00CE-J0203
For tools

Sold without cut-outs.
For custom cut-outs,

SEE
PAGE
189

Groove Trays

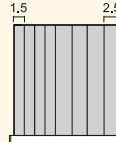

R00CE-G00803
8 groove trays

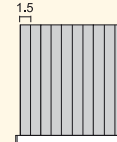

R00CE-G01003
10 groove trays

2 dividers included with each groove tray.

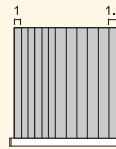

R00CE-G01203
12 groove trays

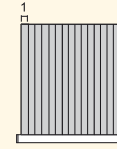

R00CE-G01603
16 groove trays

Folder Hanging Bars



R00CE-KFB12

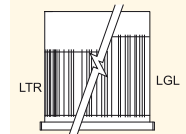

R00CE-KLR12

24" x 27" (W x D) Drawers

For Cabinet

For Multi-Drawer

Partitions and Dividers

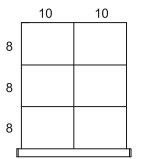

R_CG-A0104
6 compartments

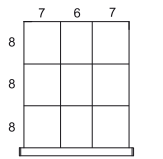

R_CG-A0206
9 compartments

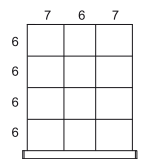

R_CG-A0209
12 compartments

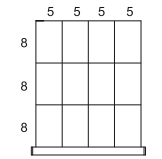

R_CG-A0308
12 compartments

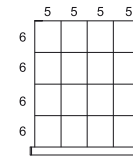

R_CG-A0312
16 compartments

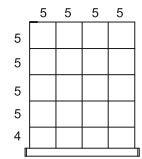

R_CG-A0316
20 compartments

Plastic Bins

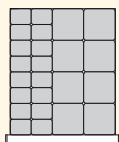

R_CG-E024
24 bins

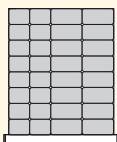

R_CG-E032
32 bins

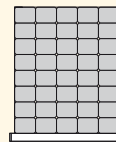

R_CG-E040
40 bins

Foam

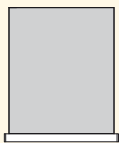

R_CG-J0103
For protection

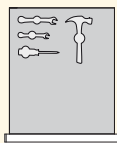

R_CG-J0203
For tools

Sold without cut-outs.
For custom cut-outs,

SEE
PAGE
189

Groove Trays

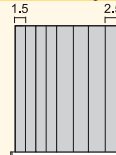

R_CG-G00803
8 groove trays

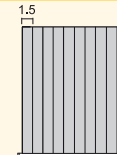

R_CG-G01003
10 groove trays

2 dividers included with each groove tray.

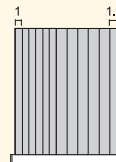

R_CG-G01203
12 groove trays

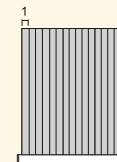

R_CG-G01603
16 groove trays

Folder Hanging Bars

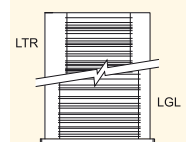

R_CG-KFB12

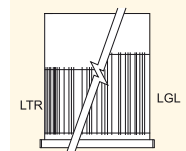

R_CG-KLR12

30" x 21" (W x D) Drawers

For Cabinet

Partitions and Dividers

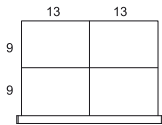

R_DD-A0102
4 compartments

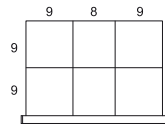

R_DD-A0203
6 compartments

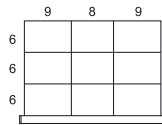

R_DD-A0206
9 compartments

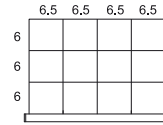

R_DD-A0308
12 compartments

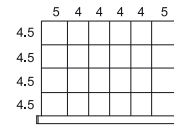

R_DD-A0518
24 compartments

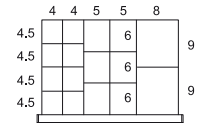

R_DD-D0411
16 compartments

Plastic Bins

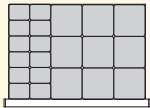

R_DD-E021
21 bins

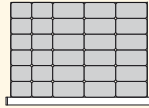

R_DD-E030
30 bins

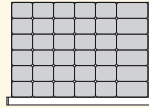

R_DD-E036
36 bins

Groove Trays

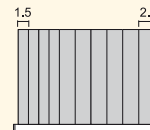

R_DD-G01003
10 groove trays

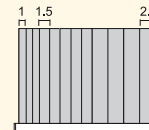

R_DD-G01203
12 groove trays

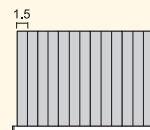

R_DD-G01303
13 groove trays

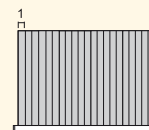

R_DD-G02103
21 groove trays

Folder Hanging Bars

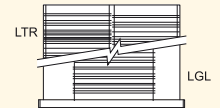

R_DD-KFB12



R_DD-KLR12

Foam



R_DD-J0103
For protection

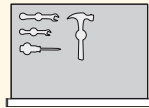

R_DD-J0203
For tools



Sold without cut-outs.
For custom cut-outs,

SEE
PAGE
189

30" x 24" (W x D) Drawers

For Shelving

For Multi-Drawer

Partitions and Dividers

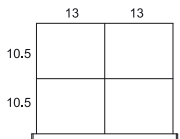

R_DE-A0102
4 compartments

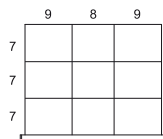

R_DE-A0206
9 compartments

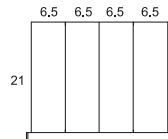

R_DE-A0300
4 compartments

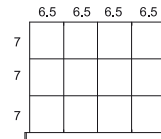

R_DE-A0308
12 compartments

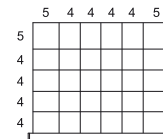

R_DE-A0524
30 compartments

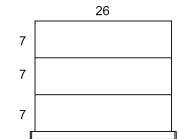

R_DE-B0200
3 compartments

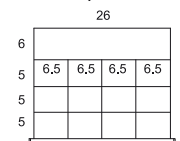

R_DE-C0408
13 compartments

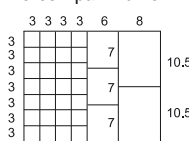

R_DE-D0527
33 compartments

Groove Trays

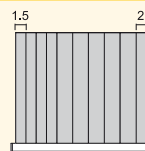

R_DE-G01003
10 groove trays

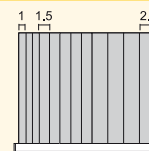

R_DE-G01203
12 groove trays

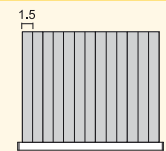

R_DE-G01303
13 groove trays

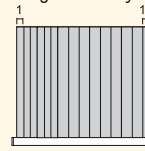

R_DE-G01503
15 groove trays

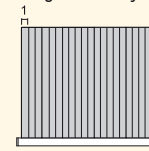

R_DE-G02103
21 groove trays

2 dividers included with each groove tray.

Plastic Bins

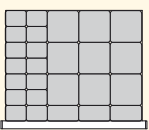

R_DE-E026
26 bins

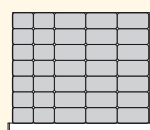

R_DE-E035
35 bins

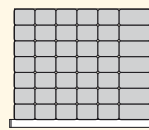

R_DE-E042
42 bins

Foam

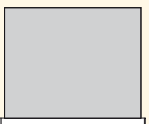

R_DE-J0103
For protection

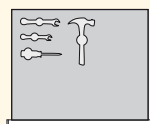

R_DE-J0203
For tools

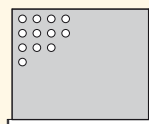

R_DE-J0303
For collets



Sold without cut-outs.
For custom cut-outs,

SEE
PAGE
189

Folder Hanging Bars

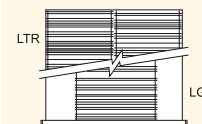

R_DE-KFB12



R_DE-KLR12

Proposals

30" x 27" (W x D) Drawers

For Cabinet

For Multi-Drawer

MODULAR DRAWER

Partitions and Dividers

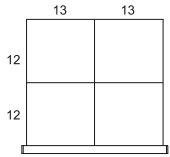

R_DG-A0102
4 compartments

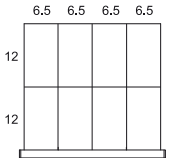

R_DG-A0304
8 compartments

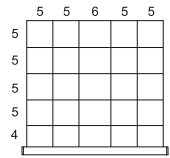

R_DG-A0420
25 compartments

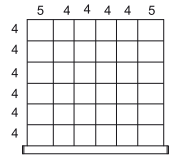

R_DG-A0530
36 compartments

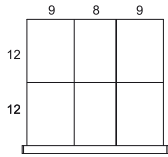

R_DG-A0203
6 compartments

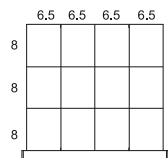

R_DG-A0308
12 compartments

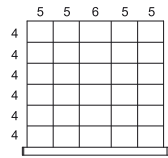

R_DG-A0425
30 compartments

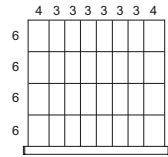

R_DG-A0724
32 compartments

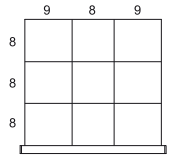

R_DG-A0206
9 compartments

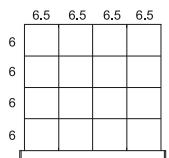

R_DG-A0312
16 compartments

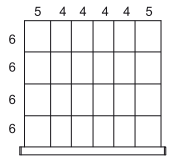

R_DG-A0518
24 compartments

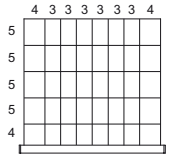

R_DG-A0732
40 compartments

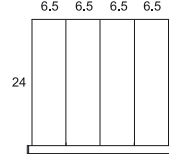

R_DG-A0300
4 compartments

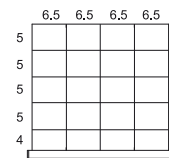

R_DG-A0316
20 compartments

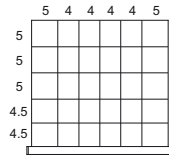

R_DG-A0524
30 compartments

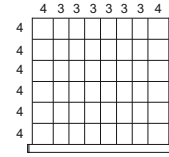

R_DG-A0740
48 compartments

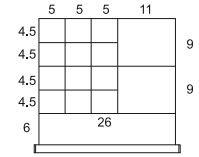

R_DG-C0410
15 compartments

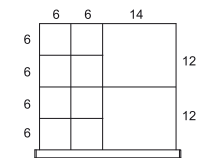

R_DG-D0207
10 compartments

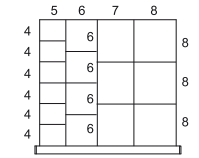

R_DG-D0312
16 compartments

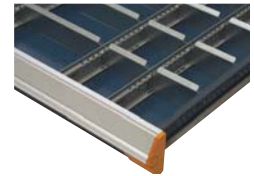

Plastic Bins

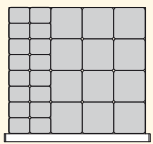

R_DG-E028
28 bins

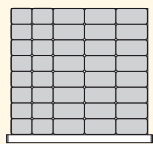

R_DG-E040
40 bins

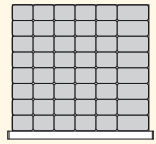

R_DG-E048
48 bins

Foam

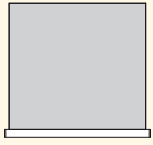

R_DG-J0103
For protection

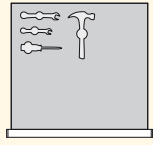

R_DG-J0203
For tools

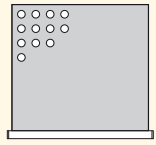

R_DG-J0303
For collets

Folder Hanging Bars

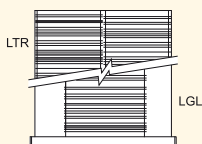

R_DG-KFB12

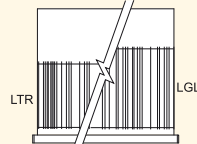

R_DG-KLR12



Sold without cut-outs.
For custom cut-outs,

SEE
PAGE
189

Groove Trays

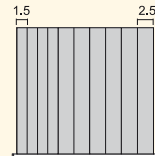

R_DG-G01003
10 groove trays

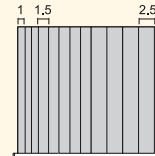

R_DG-G01203
12 groove trays

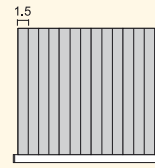

R_DG-G01303
13 groove trays

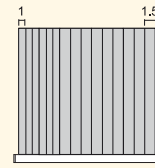

R_DG-G01503
15 groove trays

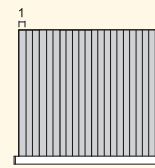

R_DG-G02103
21 groove trays

2 dividers included with
each groove tray.

36" x 18" (W x D) Drawers

For Cabinet

For Shelving

Partitions and Dividers

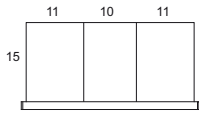

R_EC-A0200
3 compartments

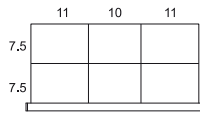

R_EC-A0203
6 compartments

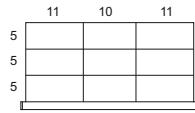

R_EC-A0206
9 compartments

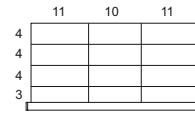

R_EC-A0209
12 compartments

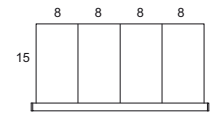

R_EC-A0300
4 compartments

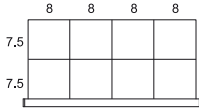

R_EC-A0304
8 compartments

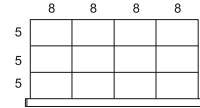

R_EC-A0308
12 compartments

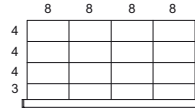

R_EC-A0312
16 compartments

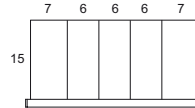

R_EC-A0400
5 compartments

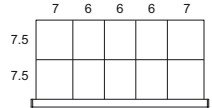

R_EC-A0405
10 compartments

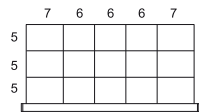

R_EC-A0410
15 compartments

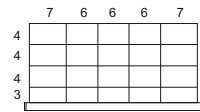

R_EC-A0415
20 compartments

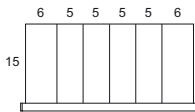

R_EC-A0500
6 compartments

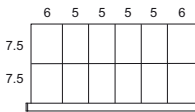

R_EC-A0506
12 compartments

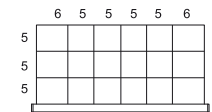

R_EC-A0512
18 compartments

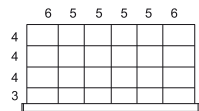

R_EC-A0518
24 compartments

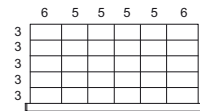

R_EC-A0524
30 compartments

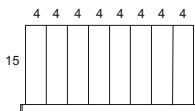

R_EC-A0700
8 compartments

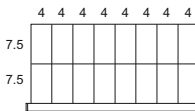

R_EC-A0708
16 compartments

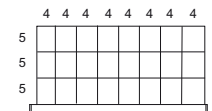

R_EC-A0716
24 compartments

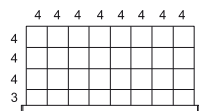

R_EC-A0724
32 compartments

Plastic Bins

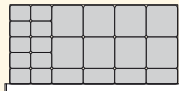

R_EC-E022
22 bins

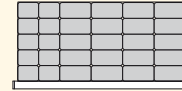

R_EC-E030
30 bins

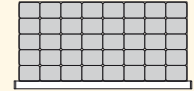

R_EC-E040
40 bins

Groove Trays

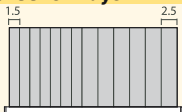

R_EC-G01303
13 groove trays

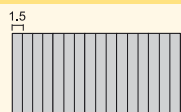

R_EC-G01603
16 groove trays

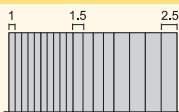

R_EC-G01803
18 groove trays

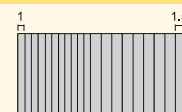

R_EC-G02003
20 groove trays



R_EC-G02603
26 groove trays

2 dividers included with each groove tray.

Foam

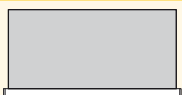

R_EC-J0103
For protection



R_EC-J0203
For tools

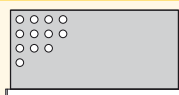

R_EC-J0303
For collets

Folder Hanging Bars

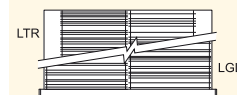

R_EC-KFB12

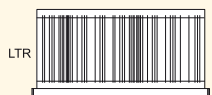

R_EC-KLR12



Sold without cut-outs.
For custom cut-outs,

SEE
PAGE
189

Proposals

36" x 24" (W x D) Drawers

For Cabinet

For Shelving

For Multi-Drawer

Partitions and Dividers

MODULAR DRAWER

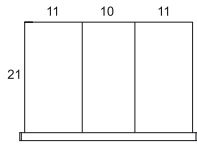

R_EE-A0200
3 compartments

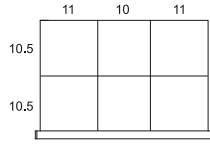

R_EE-A0203
6 compartments

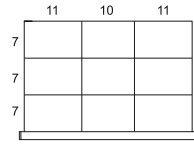

R_EE-A0206
9 compartments

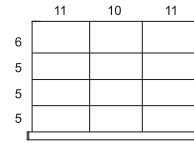

R_EE-A0209
12 compartments

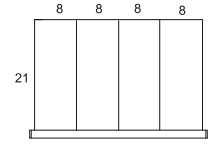

R_EE-A0300
4 compartments

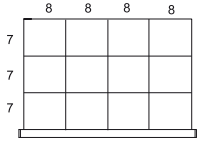

R_EE-A0308
12 compartments

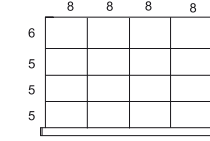

R_EE-A0312
16 compartments

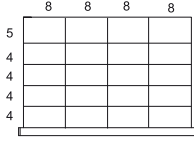

R_EE-A0316
20 compartments

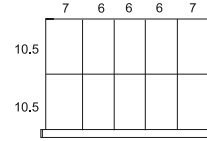

R_EE-A0405
10 compartments

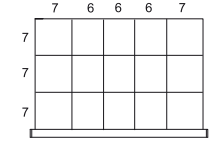

R_EE-A0410
15 compartments

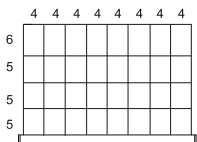

R_EE-A0724
32 compartments

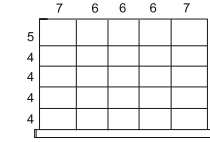

R_EE-A0420
25 compartments

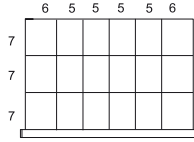

R_EE-A0512
18 compartments

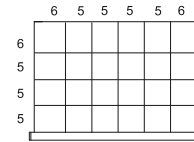

R_EE-A0518
24 compartments

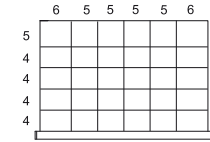

R_EE-A0524
30 compartments

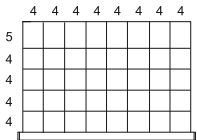

R_EE-A0732
40 compartments

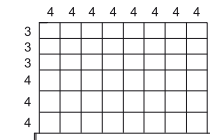

R_EE-A0740
48 compartments

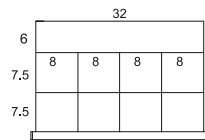

R_EE-C0404
9 compartments

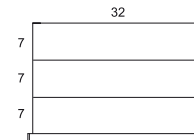

R_EE-B0200
3 compartments

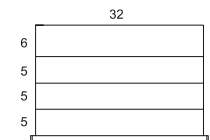

R_EE-B0300
4 compartments

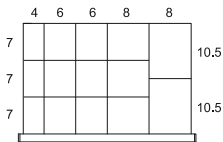

R_EE-D0409
14 compartments

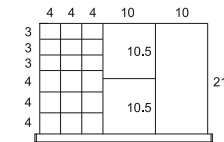

R_EE-D0416
21 compartments

Plastic Bins

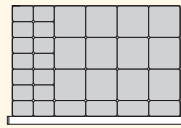

R_EE-E030
30 bins

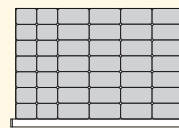

R_EE-E042
42 bins

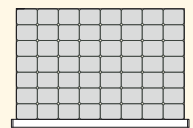

R_EE-E056
56 bins

Groove Trays

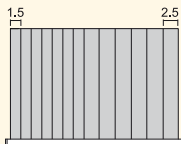

R_EE-G01303
13 groove trays

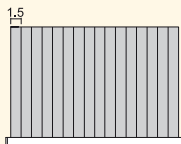

R_EE-G01603
16 groove trays

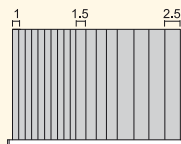

R_EE-G01803
18 groove trays

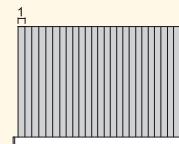

R_EE-G02603
26 groove trays

2 dividers included with each groove tray.

Foam

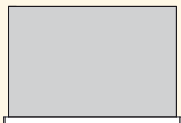

R_EE-J0103
For protection

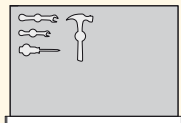

R_EE-J0203
For tools

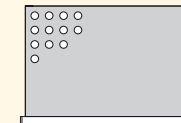

R_EE-J0303
For collets

Folder Hanging Bars

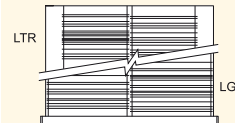

R_EE-KFB12



R_EE-KLR12

Sold without cut-outs. For custom cut-outs,

SEE PAGE 189

36" x 27" (W x D) Drawers

For Cabinet

For Multi-Drawer

Partitions and Dividers

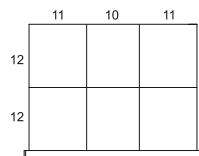

R_EG-A0203
6 compartments

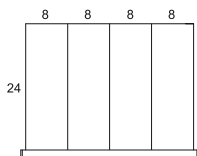

R_EG-A0300
4 compartments

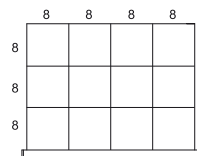

R_EG-A0308
12 compartments

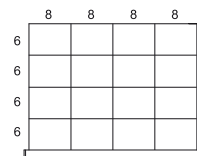

R_EG-A0312
16 compartments

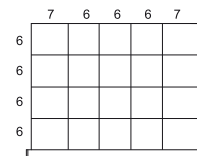

R_EG-A0415
20 compartments

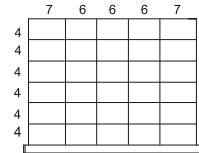

R_EG-A0425
30 compartments

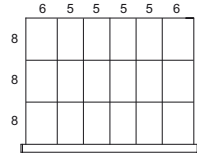

R_EG-A0512
18 compartments

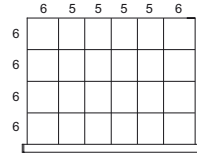

R_EG-A0518
24 compartments

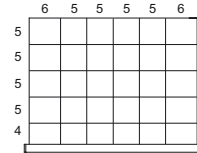

R_EG-A0524
30 compartments

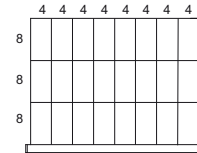

R_EG-A0716
24 compartments

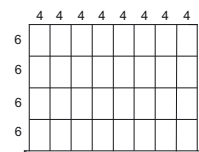

R_EG-A0724
32 compartments

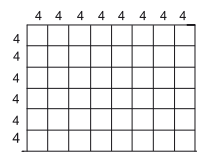

R_EG-A0740
48 compartments

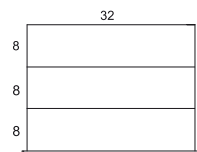

R_EG-B0200
3 compartments

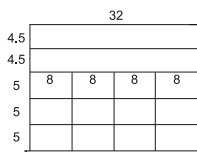

R_EG-C0508
14 compartments

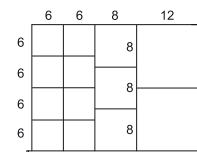

R_EG-D0309
13 compartments

Plastic Bins

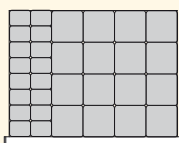

R_EG-E032
32 bins

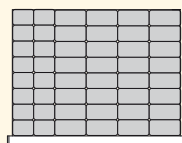

R_EG-E048
48 bins

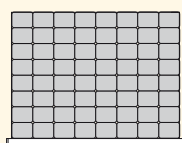

R_EG-E064
64 bins

Groove Trays

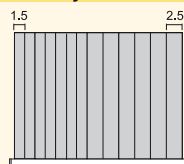

R_EG-G01303
13 groove trays

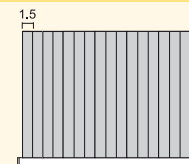

R_EG-G01603
16 groove trays

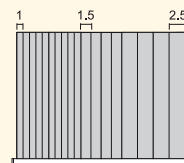

R_EG-G01803
18 groove trays

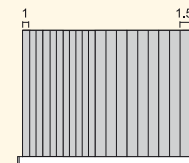

R_EG-G02003
20 groove trays

Foam

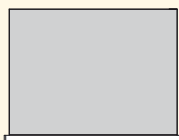

R_EG-J0103
For protection

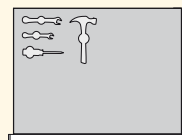

R_EG-J0203
For tools

! Sold without cut-outs.
For custom cut-outs,

SEE
PAGE
189

Folder Hanging Bars

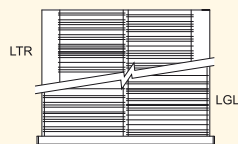

R_EG-KFB12

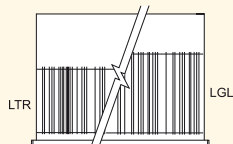

R_EG-KLR12

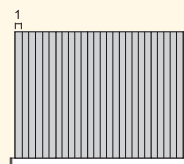
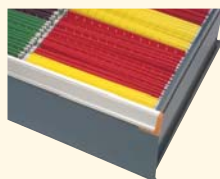

R_EG-G02603
26 groove trays

2 dividers included with each groove tray.

MODULAR DRAWER

Proposals

42" x 18" (W x D) Drawers

For Shelving

MODULAR DRAWER

Partitions and Dividers

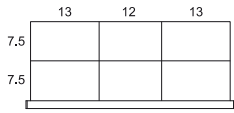

R_GC-A0203
6 compartments

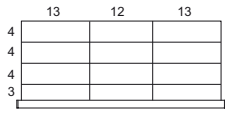

R_GC-A0209
12 compartments

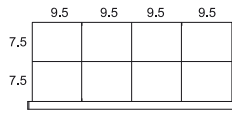

R_GC-A0304
8 compartments

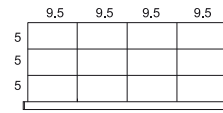

R_GC-A0308
12 compartments

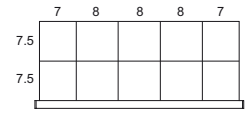

R_GC-A0405
10 compartments

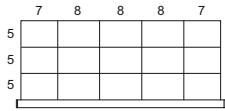

R_GC-A0410
15 compartments

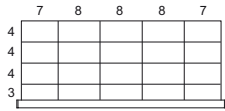

R_GC-A0415
20 compartments

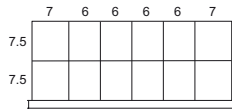

R_GC-A0506
12 compartments

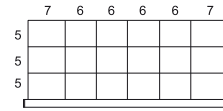

R_GC-A0512
18 compartments

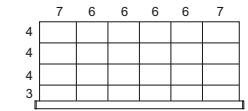

R_GC-A0518
24 compartments

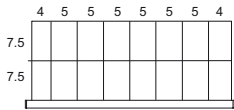

R_GC-A0708
16 compartments

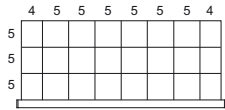

R_GC-A0716
24 compartments

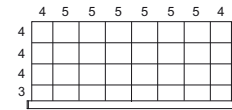

R_GC-A0724
32 compartments

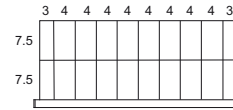

R_GC-A0910
20 compartments

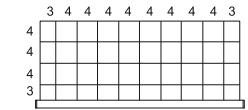

R_GC-A0930
40 compartments

Plastic Bins

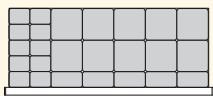

R_GC-E025
25 bins

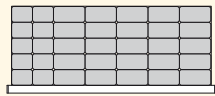

R_GC-E035
35 bins

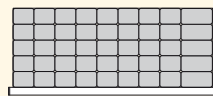

R_GC-E045
45 bins

Groove Trays

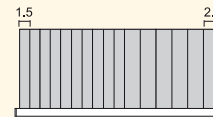

R_GC-G016
16 groove trays

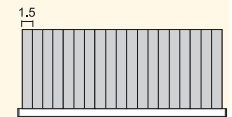

R_GC-G019
19 groove trays

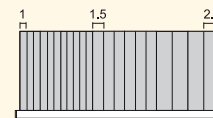

R_GC-G021
21 groove trays

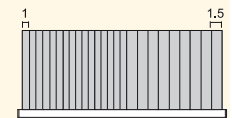

R_GC-G025
25 groove trays

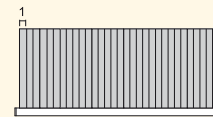

R_GC-G031
31 groove trays

2 dividers included with each groove tray.

Foam

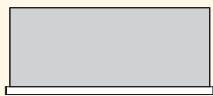

R_GC-J0103
For protection

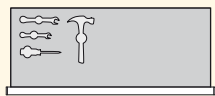

R_GC-J0203
For tools



Sold without cut-outs.
For custom cut-outs,

SEE
PAGE
189

Folder Hanging Bars

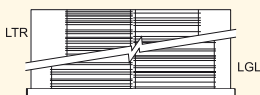

R_GC-KFB12

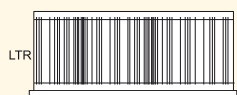

R_GC-KLR12



42" x 24" (W x D) Drawers

For Shelving

MODULAR DRAWER

Partitions and Dividers

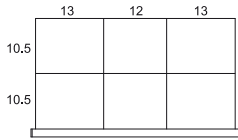

R_GE-A0203
6 compartments

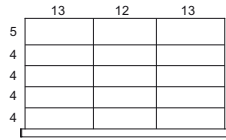

R_GE-A0212
15 compartments

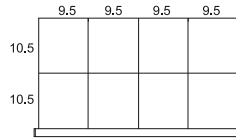

R_GE-A0304
8 compartments

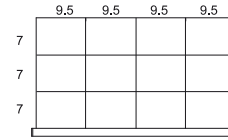

R_GE-A0308
12 compartments

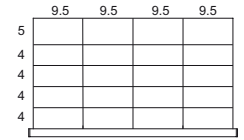

R_GE-A0316
20 compartments

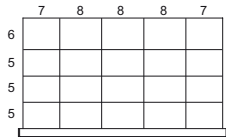

R_GE-A0415
20 compartments

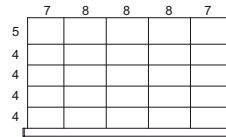

R_GE-A0420
25 compartments

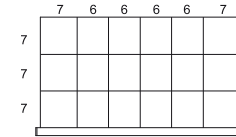

R_GE-A0512
18 compartments

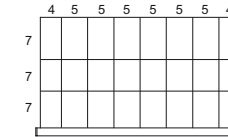

R_GE-A0716
24 compartments

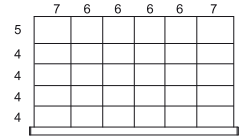

R_GE-A0524
30 compartments

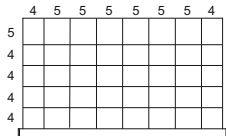

R_GE-A0732
40 compartments

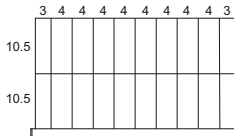

R_GE-A0910
20 compartments

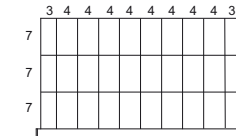

R_GE-A0920
30 compartments

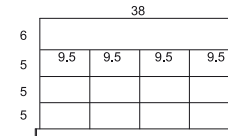

R_GE-C0408
13 compartments

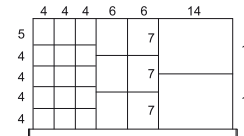

R_GE-D0517
23 compartments

Plastic Bins

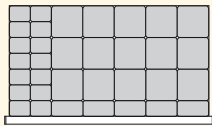

R_GE-E034
34 bins

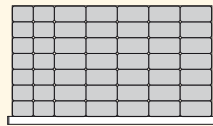

R_GE-E049
49 bins

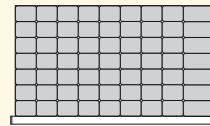

R_GE-E063
63 bins

Foam

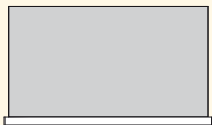

R_GE-J0103
For protection

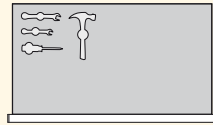

R_GE-J0203
For tools

Sold without cut-outs.
For custom cut-outs,

SEE
PAGE
189

Folder Hanging Bars

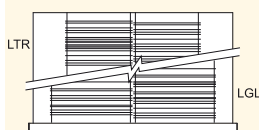

R_GE-KFB12

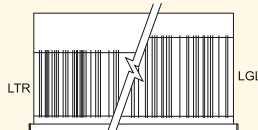

R_GE-KLR12

Groove Trays

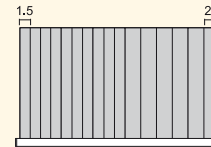

R_GE-G01603
16 groove trays

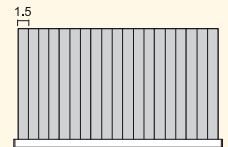

R_GE-G01903
19 groove trays

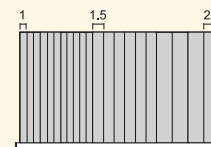

R_GE-G02103
21 groove trays

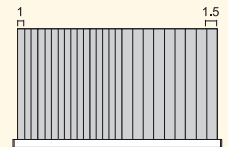

R_GE-G02503
25 groove trays

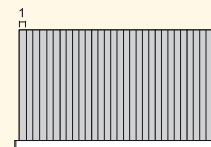

R_GE-G03103
31 groove trays

2 dividers included with each groove tray.



Proposals

48" x 18" (W x D) Drawers

For Shelving

Partitions and Dividers

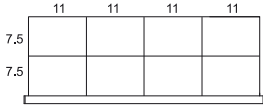

R_HC-A0304
8 compartments

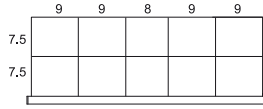

R_HC-A0405
10 compartments

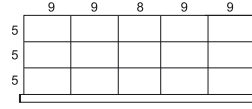

R_HC-A0410
15 compartments

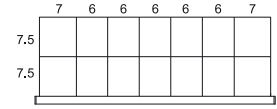

R_HC-A0607
14 compartments

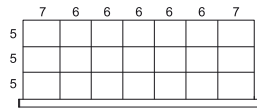

R_HC-A0614
21 compartments

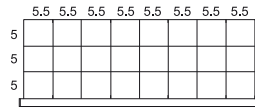

R_HC-A0716
24 compartments

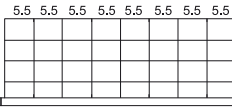

R_HC-A0724
32 compartments

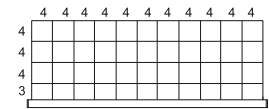

R_HC-A1033
44 compartments

Plastic Bins

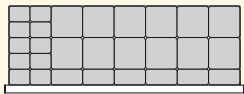

R_HC-E028
28 bins

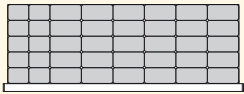

R_HC-E040
40 bins

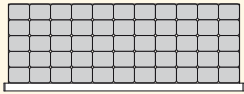

R_HC-E055
55 bins

Foam

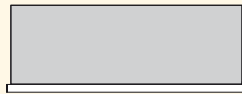

R_HC-J0103
For protection

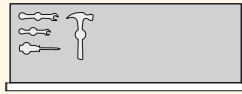

R_HC-J0203
For tools

 Sold without cut-outs.
For custom cut-outs,

SEE
PAGE
189

Groove Trays

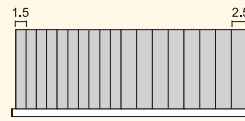

R_HC-G01803
18 groove trays

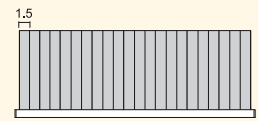

R_HC-G02203
22 groove trays

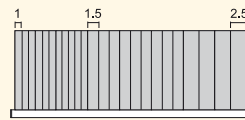

R_HC-G02403
24 groove trays

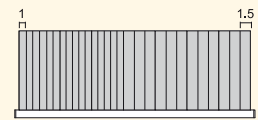

R_HC-G02803
28 groove trays

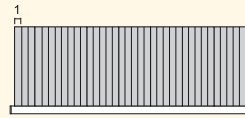

R_HC-G03603
36 groove trays

2 dividers included with
each groove tray.

Folder Hanging Bars

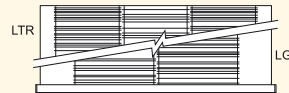

R_HC-KFB12

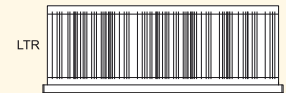

R_HC-KLR12



MODULAR DRAWER

48" x 24" (W x D) Drawers

For Cabinet

For Shelving

For Multi-Drawer

Partitions and Dividers

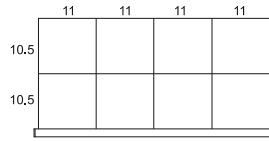

R_HE-A0304
8 compartments

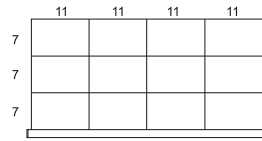

R_HE-A0308
12 compartments

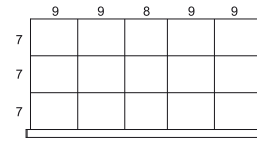

R_HE-A0410
15 compartments

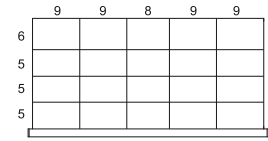

R_HE-A0415
20 compartments

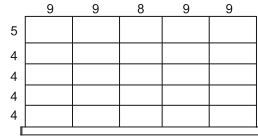

R_HE-A0420
25 compartments

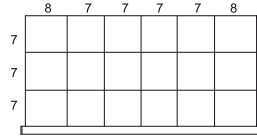

R_HE-A0512
18 compartments

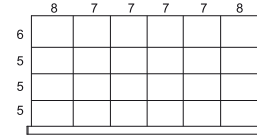

R_HE-A0518
24 compartments

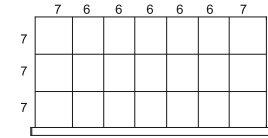

R_HE-A0614
21 compartments

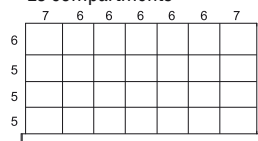

R_HE-A0621
28 compartments

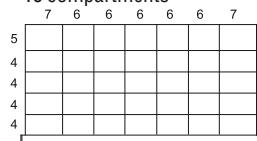

R_HE-A0628
35 compartments

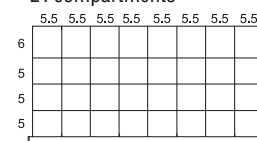

R_HE-A0724
32 compartments

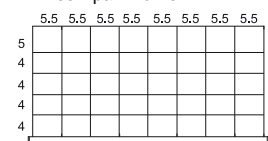

R_HE-A0732
40 compartments

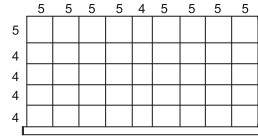

R_HE-A0836
45 compartments

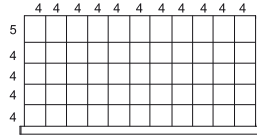

R_HE-A1044
55 compartments

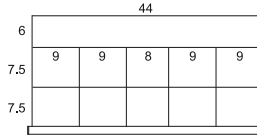

R_HE-C0505
11 compartments

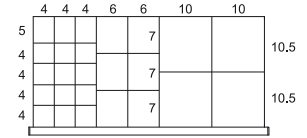

R_HE-D0618
25 compartments

Plastic Bins

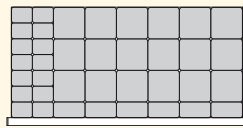

R_HE-E038
38 bins

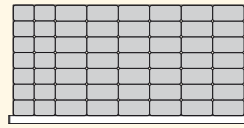

R_HE-E056
56 bins

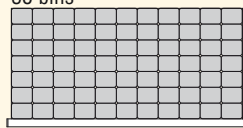

R_HE-E077
77 bins

Groove Trays

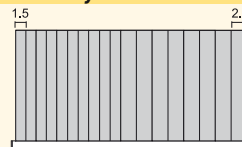

R_HE-G01803
18 groove trays

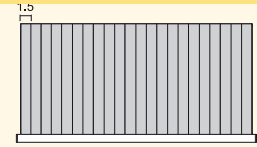

R_HE-G02203
22 groove trays

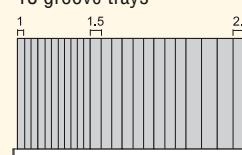

R_HE-G02403
24 groove trays

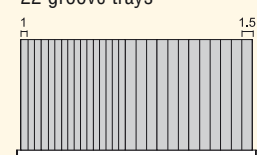

R_HE-G02803
28 groove trays

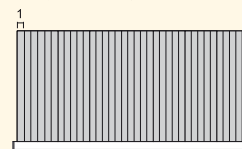

R_HE-G03603
36 groove trays

2 dividers included with each groove tray.

Folder Hanging Bars

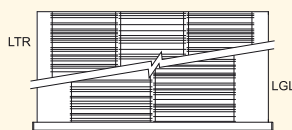

R_HE-KFB12

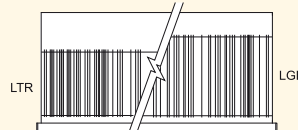

R_HE-KLR12

Foam

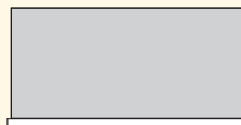

R_HE-J0103
For protection

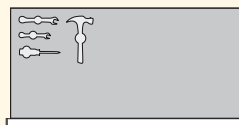

R_HE-J0203
For tools

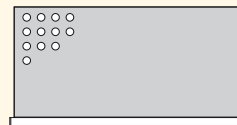

R_HE-J0303
For collets



Sold without cut-outs.
For custom cut-outs,

SEE PAGE 189

Proposals

48" x 27" (W x D) Drawers

For Cabinet

For Multi-Drawer

MODULAR DRAWER

Partitions and Dividers

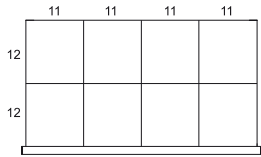

R_HG-A0304
8 compartments

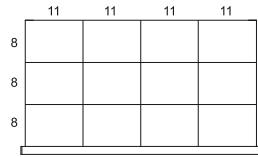

R_HG-A0308
12 compartments

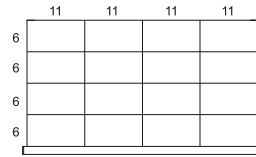

R_HG-A0312
16 compartments

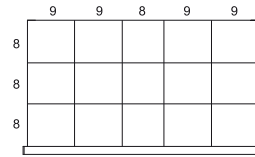

R_HG-A0410
15 compartments

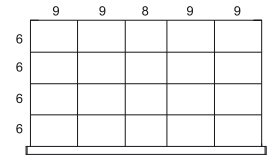

R_HG-A0415
20 compartments

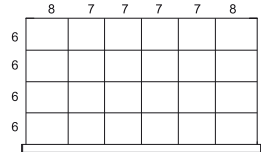

R_HG-A0518
24 compartments

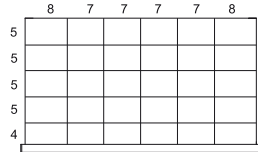

R_HG-A0524
30 compartments

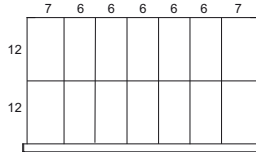

R_HG-A0607
14 compartments

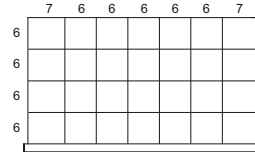

R_HG-A0621
28 compartments

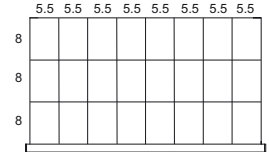

R_HG-A0716
24 compartments

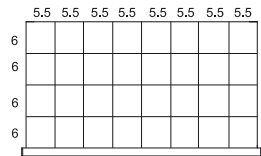

R_HG-A0724
32 compartments

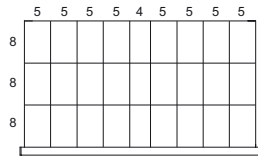

R_HG-A0818
27 compartments

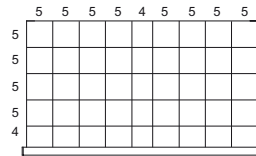

R_HG-A0836
45 compartments

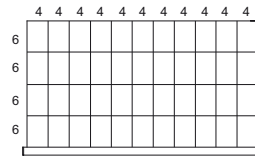

R_HG-A1033
44 compartments

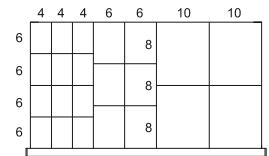

R_HG-D0615
22 compartments

Plastic Bins

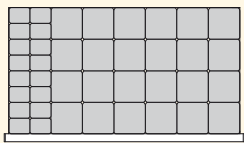

R_HG-E040
40 bins

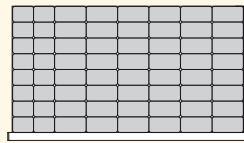

R_HG-E064
64 bins

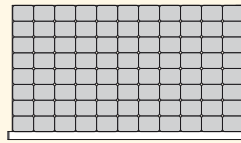

R_HG-E088
88 bins

Groove Trays

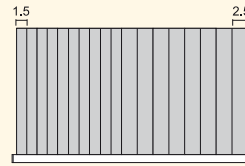

R_HG-G01803
18 groove trays

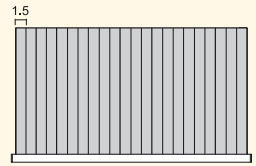

R_HG-G02203
22 groove trays

Foam

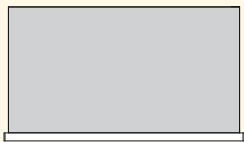

R_HG-J0103
For protection

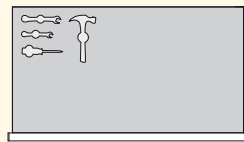

R_HG-J0203
For tools

Sold without cut-outs.
For custom cut-outs,

SEE
PAGE
189

Folder Hanging Bars

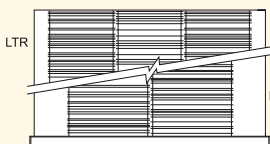

R_HG-KFB12

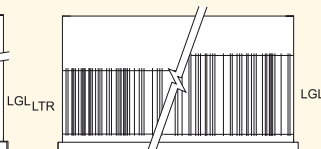

R_HG-KLR12

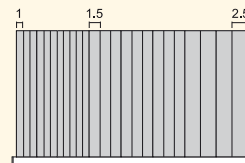

R_HG-G02403
24 groove trays

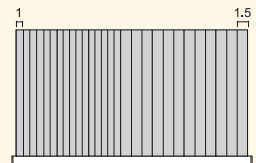

R_HG-G02803
28 groove trays

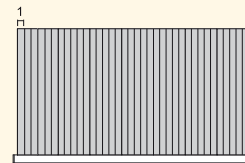

R_HG-G03603
36 groove trays

2 dividers included
with each groove tray.

60" x 24" (W x D) Drawers

For Cabinet

For Multi-Drawer

Partitions and Dividers

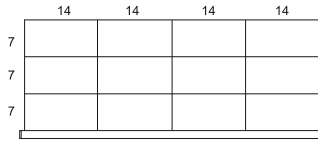

R_KE-A0308
12 compartments

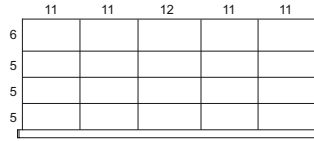

R_KE-A0415
20 compartments

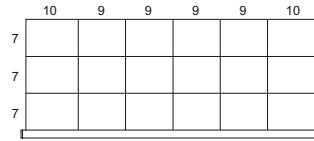

R_KE-A0512
18 compartments

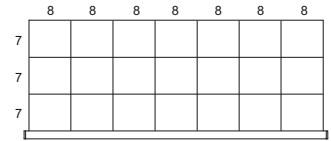

R_KE-A0614
21 compartments

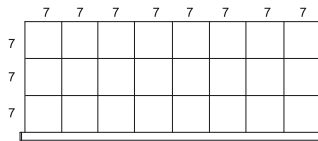

R_KE-A0716
24 compartments

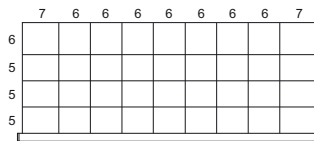

R_KE-A0827
36 compartments

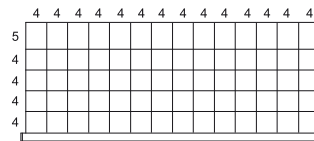

R_KE-A1356
70 compartments

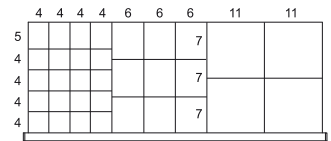

R_KE-D0824
33 compartments

MODULAR DRAWER

Plastic Bins

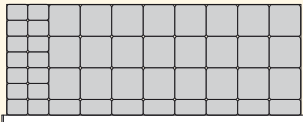

R_KE-E046
46 bins

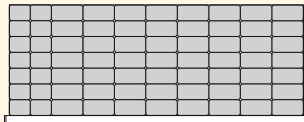

R_KE-E070
70 bins

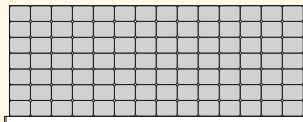

R_KE-E098
98 bins

Foam

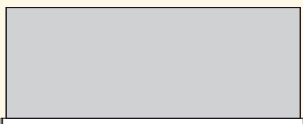

R_KE-J0103
For protection

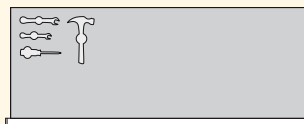

R_KE-J0203
For tools

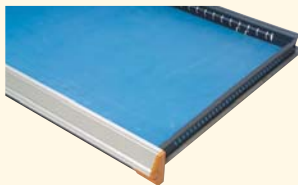

Sold without cut-outs.
For custom cut-outs,

SEE
PAGE
189

Groove Trays

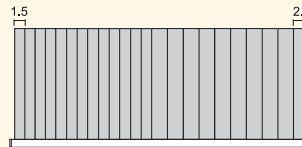

R_KE-G02303
23 groove trays

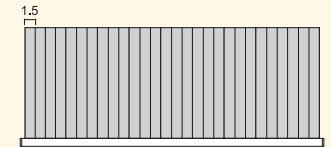

R_KE-G02803
28 groove trays

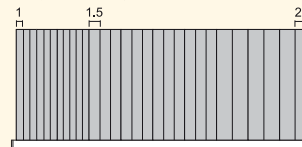

R_KE-G02903
29 groove trays

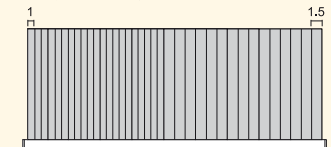

R_KE-G03603
36 groove trays

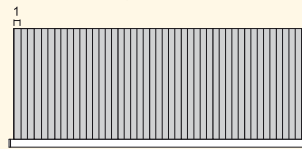

R_KE-G04603
46 groove trays

2 dividers included
with each groove tray.

Folder Hanging Bars

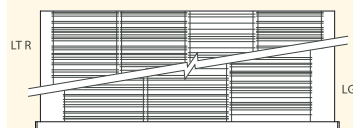

R_KE-KFB12



Proposals

60" x 27" (W x D) Drawers

For Cabinet

For Multi-Drawer

Partitions and Dividers

MODULAR DRAWER

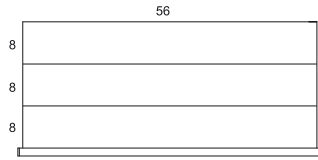

R_KG-B0200
3 compartments

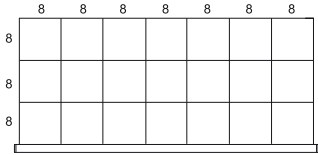

R_KG-A0614
21 compartments

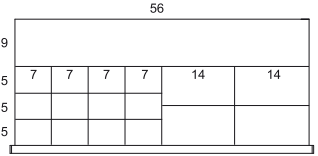

R_KG-C0610
17 compartments

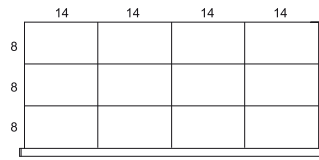

R_KG-A0308
12 compartments

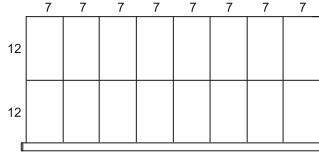

R_KG-A0708
16 compartments

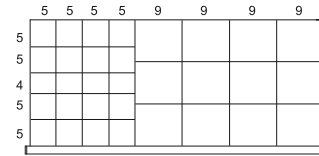

R_KG-D0724
32 compartments

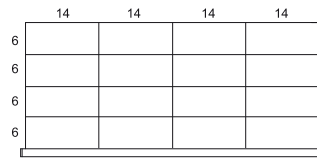

R_KG-A0312
16 compartments

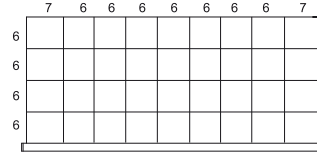

R_KG-A0827
36 compartments

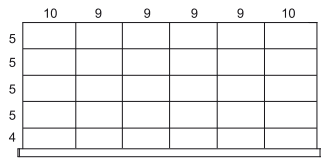

R_KG-A0524
30 compartments

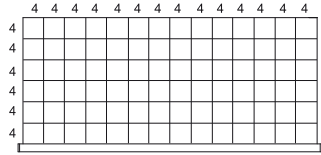

R_KG-A1370
84 compartments

Plastic Bins

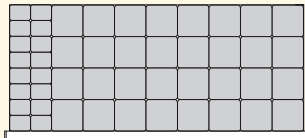

R_KG-E048
48 bins

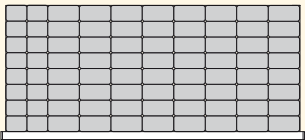

R_KG-E080
80 bins

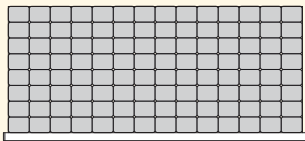

R_KG-E112
112 bins

Foam

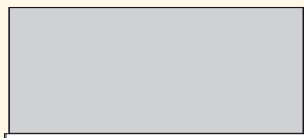

R_KG-J0103
For protection

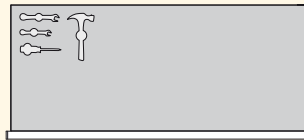

R_KG-J0203
For tools

 Sold without cut-outs.
For custom cut-outs, SEE PAGE 189

Groove Trays

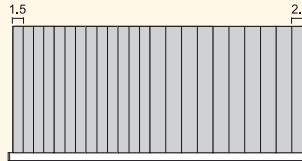

R_KG-G02303
23 groove trays

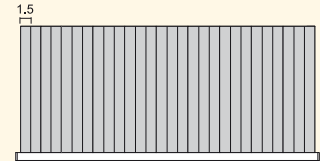

R_KG-G02803
28 groove trays

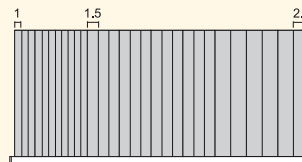

R_KG-G02903
29 groove trays

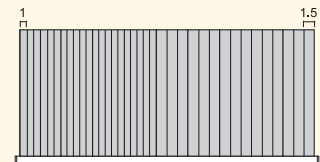

R_KG-G03603
36 groove trays

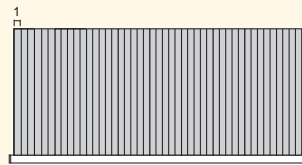

R_KG-G04603
46 groove trays

2 dividers included
with each groove tray.

Folder Hanging Bars

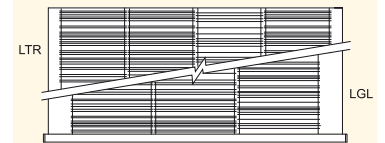

R_KG-KFB12



Partitioning Accessories

The layout connection system (snap-on) keeps the dividers in place and reduces noise caused by vibrations.



Front to Back Partition

RG00

Divides the drawer along its depth;
 Dividers are locked into place by clip system;
 Adjustable every inch center to center (c/c);
 Compatible with the following accessories : plastic bins, groove trays, hanging file bars and drawer liners.

Drawer Depth Nominal (real)	Drawer Height						
	3" 1 5/8" high	4" 2 5/8" high	5" 3 5/8" high	6" and 7" 4 5/8" high	8" and 9" 6 5/8" high	10" 8 5/8" high	12" and 14" 10 5/8" high
18" (15")	RG00-1803	RG00-1804	RG00-1805	RG00-1806	RG00-1808	RG00-1810	RG00-1812
21" (18")	RG00-2103	RG00-2104	RG00-2105	RG00-2106	RG00-2108	RG00-2110	RG00-2112
24" (21")	RG00-2403	RG00-2404	RG00-2405	RG00-2406	RG00-2408	RG00-2410	RG00-2412
27" (24")	RG00-2703	RG00-2704	RG00-2705	RG00-2706	RG00-2708	RG00-2710	RG00-2712

Left to Right Partition

RG01

Divides the drawer along its width;
 Dividers are locked into place by clip system;
 Adjustable every half inch center to center (c/c);
 Compatible with the following accessories : plastic bins, groove trays, hanging file bars and drawer liners.

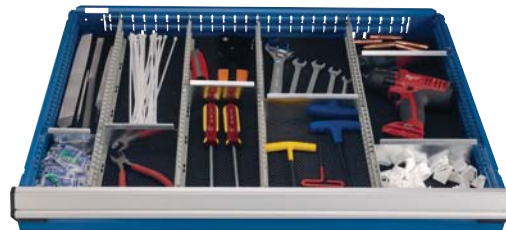

Drawer Width Nominal (real)	Drawer Height						
	3" 1 5/8" high	4" 2 5/8" high	5" 3 5/8" high	6" and 7" 4 5/8" high	8" and 9" 6 5/8" high	10" 8 5/8" high	12" and 14" 10 5/8" high
24" (20")	RG01-2403	RG01-2404	RG01-2405	RG01-2406	RG01-2408	RG01-2410	RG01-2412
30" (26")	RG01-3003	RG01-3004	RG01-3005	RG01-3006	RG01-3008	RG01-3010	RG01-3012
36" (32")	RG01-3603	RG01-3604	RG01-3605	RG01-3606	RG01-3608	RG01-3610	RG01-3612
42" (38")	RG01-4203	RG01-4204	RG01-4205	RG01-4206	RG01-4208	RG01-4210	RG01-4212
48" (44")	RG01-4803	RG01-4804	RG01-4805	RG01-4806	RG01-4808	RG01-4810	RG01-4812
60" (56")	RG01-6003	RG01-6004	RG01-6005	RG01-6006	RG01-6008	RG01-6010	RG01-6012

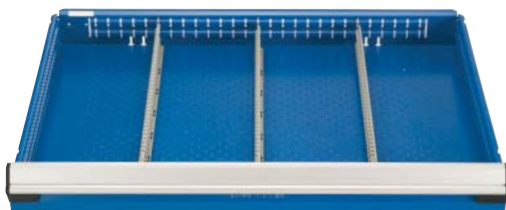

Front to back partition (RG00)



Left to right partition (RG01)

Accessories

Drawer Divider

RG10

Clips into place;
45° angle at top for easy retrieval and identification of parts;
Adjustable every half inch center to center (c/c).

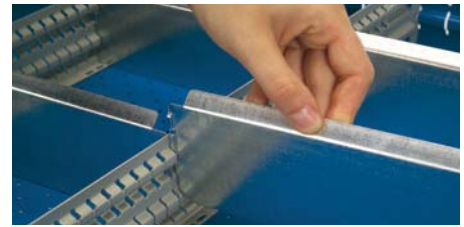

MODULAR DRAWER

Divider Width Nominal (real)	Drawer Height						
	3" 1 5/8" high	4" 2 5/8" high	5" 3 5/8" high	6" and 7" 4 5/8" high	8" and 9" 6 5/8" high	10" 8 5/8" high	12" and 14" 10 5/8" high
3"	RG10-03003	RG10-03004	RG10-03005	RG10-03006	-	-	-
3.5"	RG10-03503	RG10-03504	RG10-03505	RG10-03506	-	-	-
4"	RG10-04003	RG10-04004	RG10-04005	RG10-04006	-	-	-
5"	RG10-05003	RG10-05004	RG10-05005	RG10-05006	RG10-05008	RG10-05010	-
5.5"	RG10-05503	RG10-05504	RG10-05505	RG10-05506	RG10-05508	RG10-05510	-
6"	RG10-06003	RG10-06004	RG10-06005	RG10-06006	RG10-06008	RG10-06010	RG10-06012
6.5"	RG10-06503	RG10-06504	RG10-06505	RG10-06506	RG10-06508	RG10-06510	RG10-06512
7"	RG10-07003	RG10-07004	RG10-07005	RG10-07006	RG10-07008	RG10-07010	RG10-07012
8"	RG10-08003	RG10-08004	RG10-08005	RG10-08006	RG10-08008	RG10-08010	RG10-08012
9"	RG10-09003	RG10-09004	RG10-09005	RG10-09006	RG10-09008	RG10-09010	RG10-09012
9.5"	RG10-09503	RG10-09504	RG10-09505	RG10-09506	RG10-09508	RG10-09510	RG10-09512
10"	RG10-10003	RG10-10004	RG10-10005	RG10-10006	RG10-10008	RG10-10010	RG10-10012
11"	RG10-11003	RG10-11004	RG10-11005	RG10-11006	RG10-11008	RG10-11010	RG10-11012
12"	RG10-12003	RG10-12004	RG10-12005	RG10-12006	RG10-12008	RG10-12010	RG10-12012
13"	RG10-13003	RG10-13004	RG10-13005	RG10-13006	RG10-13008	RG10-13010	RG10-13012
14"	RG10-14003	RG10-14004	RG10-14005	RG10-14006	RG10-14008	RG10-14010	RG10-14012
16"	RG10-16003	RG10-16004	RG10-16005	RG10-16006	RG10-16008	RG10-16010	RG10-16012

*These dimensions are not compatible with all the width of drawer.

Label Holder

RG51

Made of transparent, matte finished plastic that eliminates glare. Labels are easy to read.

Once clipped in place, the label holders are firmly attached and do not come off when retrieving an object;

Have a fold to protect label from damage;

Available in two sizes : 2" for all applications (universal) and 2 3/4" for accessories wider than 3";

Can be attached to drawer partitions and dividers;

Note : Paper strips are not included with the label holder but are available in packs of 200.

Product #	Width
RG51-200	2"
RG51-275	2 3/4"

Paper strips (packs of 200) RG53

Product #	W x H
RG53-275875	2 3/4" x 7/8"

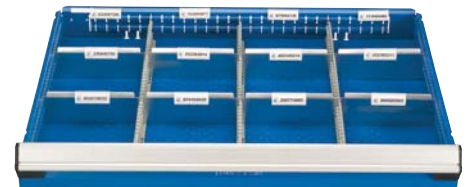

Groove Tray

RG35

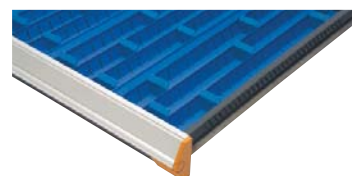

Useful in storing and protecting long objects such as drill bits, borers, sockets, lathe parts, files, tools, etc.;

Blue color for easy retrieval of parts;

Designed for 3" and 4" high drawers;

Compatible with the following accessories: partitions, dividers and plastic bins;

Available nominal depths : 18", 21", 24" and 27";

Order by adding drawer depth to groove tray product #.
Ex. : RG35-062425.

Product #	Diagram	Divider #
RG35-04__10		RG39-10
RG35-06__10		
RG35-04__15		RG39-15
RG35-06__15		
RG35-06__25		RG39-25

Drawer Accessories

Foam for Protection

RG41

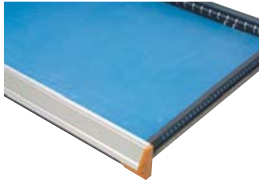

Protects stored material;
Blue foam, 1/4" thick;
Note : Partitions and dividers may not be used with this foam.

Product #	For Drawer
RG41-2421-01	24"W x 21"D
RG41-2424-01	24"W x 24"D
RG41-2427-01	24"W x 27"D
RG41-3021-01	30"W x 21"D
RG41-3024-01	30"W x 24"D
RG41-3027-01	30"W x 27"D
RG41-3618-01	36"W x 18"D
RG41-3624-01	36"W x 24"D
RG41-3627-01	36"W x 27"D

Product #	For Drawer
RG41-4218-01	42"W x 18"D
RG41-4224-01	42"W x 24"D
RG41-4818-01	48"W x 18"D
RG41-4824-01	48"W x 24"D
RG41-4827-01	48"W x 27"D
RG41-6024-01	60"W x 24"D
RG41-6027-01	60"W x 27"D

Foam for Tools

RG42



Oil-resistant and non-absorbent;
1 blue foam, 1/4" thick;
1 black self-adhesive 1/2" thick foam;
Sold without cut-outs. May be cut using a utility knife.

Product #	For Drawer
RG42-2421-01	24"W x 21"D
RG42-2424-01	24"W x 24"D
RG42-2427-01	24"W x 27"D
RG42-3021-01	30"W x 21"D
RG42-3024-01	30"W x 24"D
RG42-3027-01	30"W x 27"D
RG42-3618-01	36"W x 18"D
RG42-3624-01	36"W x 24"D
RG42-3627-01	36"W x 27"D



Sold without cut-outs.
For custom cut-outs,

SEE
PAGE
189

Handle Protector

RF70



Installs by clipping onto the drawer or roll-out shelf handle;
Made of transparent, matte finished plastic that eliminates glare. Labels are easy to read;
Protects identification labels from dust, grease and dirt;
Easy to remove.

Product #	Width
RF70-24	24"
RF70-30	30"
RF70-36	36"
RF70-42	42"
RF70-48	48"
RF70-60	60"

Foam for Collets

RG43

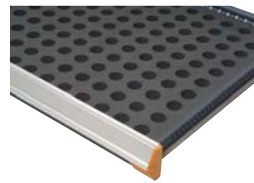

Oil-resistant and non-absorbent;
Black foam, 1" thick;
Sold without cut-outs. May be cut using a hole punch.

Product #	For Drawer
RG43-3021-01	30"W x 21"D
RG43-3024-01	30"W x 24"D
RG43-3027-01	30"W x 27"D
RG43-3618-01	36"W x 18"D
RG43-3624-01	36"W x 24"D



Sold without cut-outs.
For custom cut-outs,

SEE
PAGE
189

Labels



RF71



Labels designed to be inserted on handles under the handle protector (RF70);
4.25" W x 1" H;
22 labels per page (10 pages);
Print the labels of your choice. A template is available at www.rousseau-metal.com in the Information Centre section.

Product #
RF71-425100

PVC Drawer Liner

RG40

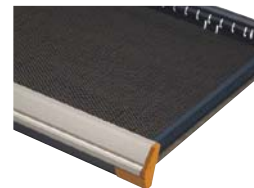

Protects stored material;
Non-skid surface;
May be installed under partitions and dividers;
Thickness : 3/32";
Note : Not for use with ESD cabinets.

Product #	For Drawer
RG40-2421-01	24"W x 21"D
RG40-2424-01	24"W x 24"D
RG40-2427-01	24"W x 27"D
RG40-3021-01	30"W x 21"D
RG40-3024-01	30"W x 24"D
RG40-3027-01	30"W x 27"D
RG40-3618-01	36"W x 18"D
RG40-3624-01	36"W x 24"D
RG40-3627-01	36"W x 27"D

Product #	For Drawer
RG40-4218-01	42"W x 18"D
RG40-4224-01	42"W x 24"D
RG40-4818-01	48"W x 18"D
RG40-4824-01	48"W x 24"D
RG40-4827-01	48"W x 27"D
RG40-6024-01	60"W x 24"D
RG40-6027-01	60"W x 27"D

Accessories

MODULAR DRAWER

Plastic Bin



RG20



Simplify storing, moving and managing small items. Lightweight and resistant;

Designed for 3" and 4" high drawers;

45° angle for easy identification of bin contents and removal of bins;

Compatible with louvered panels (SH65, SH66 and WM55) and plastic bin rails (SH62 and WM28);

Compatible with the following accessories : partitions, dividers and groove trays;

6" bins can be partitioned.



Dimensions			Bin	Product #	
W	D	H		Partition	Divider
3"	3"	2"	RG20-030302	-	-
4"	3"	2"	RG20-040302	-	-
6"	3"	2"	RG20-060302	RG22-0302	-
6"	6"	2"	RG20-060602	RG22-0602	RG24-0602
3"	3"	3"	RG20-030303	-	-
4"	3"	3"	RG20-040303	-	-
6"	3"	3"	RG20-060303	RG22-0303	-
6"	6"	3"	RG20-060603	RG22-0603	RG24-0603

Conductive Plastic Bin



RG21



Dissipates electric charges that can damage electronic components;

Make storing, moving and inventory of small parts easier. Lightweight and resistant;

Designed for 3" and 4" high drawers;

45° angle for easy identification of bin contents and removal of bins;

Compatible with louvered panels (SH65, SH66 and WM55) and plastic bin rails (SH62 and WM28);

Compatible with the following accessories : partitions, dividers and groove trays;

Color : Black;

6" bins can be partitioned.



Dimensions			Bin	Product #	
W	D	H		Partition	Divider
3"	3"	2"	RG20-030302	-	-
4"	3"	2"	RG20-040302	-	-
6"	3"	2"	RG20-060302	RG22-0302	-
6"	6"	2"	RG20-060602	RG22-0602	RG24-0602
3"	3"	3"	RG20-030303	-	-
4"	3"	3"	RG20-040303	-	-
6"	3"	3"	RG20-060303	RG22-0303	-
6"	6"	3"	RG20-060603	RG22-0603	RG24-0603

Label Holder with Adhesive Strip for Plastic Bin

RG52



Made of transparent, matte finished plastic that eliminates glare. Labels are easy to read;

Adhesive strip for installation on the RG20 plastic bins. Also for installation to the back of the drawer, allowing identification of the last compartment;

Has a fold to protect label from damage;

Note : Paper strips are not included with the label holder but are available in packs of 200.

Product #	Width
RG52-200	2"

Paper strips (packs of 200) RG53

Product #	W x H
RG53-275875	2 3/4" x 7/8"

Hanging File Bars

RG30 / RG31

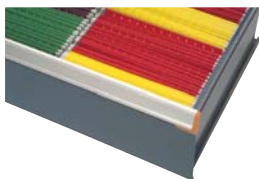

Designed to store hanging files;
For storing either letter or legal size files, depending on the drawer dimensions. See page 136 for inside dimensions of drawers;
Made for 12" and 14" high drawers;
Compatible with partitions and dividers.

Front to Back Bars		Left to Right Bars	
Product #	Nominal depth (real)	Product #	Nominal depth (real)
RG30-18	18" (15")	RG31-24	24" (20")
RG30-21	21" (18")	RG31-30	30" (26")
RG30-24	24" (21")	RG31-36	36" (32")
RG30-27	27" (24")	RG31-42	42" (38")
		RG31-48	48" (44")

Waste & Recycling Drawer



Allows sorting objects for recycling;
Identification on the drawer handle to facilitate sorting;
Drawer heights available : 17" and 26";
The 17" H drawer has two containers of 14 3/8" W x 10 1/4" D x 15" H, the black one for waste and the blue one for recycling;
The 26" H drawer has two containers of 15 1/4" W x 11" D x 20" H, the black one for waste and the blue one for recycling;
The drawer has one divider to stabilize the containers and also allows storing objects behind;
To add a locking or security mechanism, complete with product # needed.
Ex. : R51CG-X1701A to add an integrated lock-in mechanism.



R5XLG-3004

Product #	W x D x H
R51CG-X1701	24" x 27" x 17"
R51CG-X2601	24" x 27" x 26"
R51DG-X1701	30" x 27" x 17"
R51DG-X2601	30" x 27" x 26"

MODULAR DRAWER

Locking and Security Mechanisms

Integrated Lock-In Mechanism



A



Activated by tilting the handle up;
Allows you to open the drawer and roll-out shelf with one hand only;
Close the drawer and roll-out shelf by simply pushing it;
Stops drawer and roll-out shelf from opening on their own in mobile applications;
Easy to retrofit;
Order by adding A to the drawer or roll-out shelf or partitioning model number.
Ex. : RF32-362406A.

Product #

A

Econo Lock-In Mechanism

B

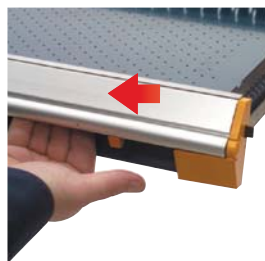

Activated with the right hand by sliding the mechanism with your thumb;
Drawer and roll-out shelf close without having to reactivate the slide mechanism;
Stops drawer and roll-out shelf from opening on their own;
Order by adding B to the drawer or roll-out shelf or partitioning model number.
Ex. : RF32-362406B.

Product #

B

Lock-Out Mechanism

RF85



For both drawers and roll-out shelves;
Locks in open position;
Activated manually, only when required;
No interference with drawer accessories.

Product #

RF85

Drawer Lock

L3

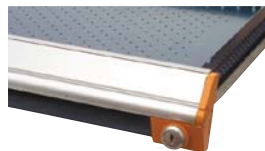

Compatible with all drawer and roll-out shelf dimensions;
Does not affect usable drawer space;
Easy to retrofit;

Order by adding L3 to drawer or partitioning model number.
Ex. : RF32-362406L3.

Product #

L3



Computer Station

COMPUTER STATION



COMPUTER STATION

Rousseau offers you a range of products and accessories to complete and complement your computer station. Computers are an integral part of all services, they require constant changes and updating, and this can change from one workspace to another.

In addition to the computer cabinet, Rousseau offers supports for monitors and keyboards. These are available in a wall-mounted version and for use with the multi-purpose frame, as well as the wall-mounted smart computer cabinet. All of these products will be very useful for your workspace.

No matter what your need is, Rousseau can supply a solution that is tailored to your situation. In addition, with Rousseau products, you will see the difference in the quality and the attention to detail.



R5JDG-5801

Computer Station

One Stop Solution

With our vast range of products and accessories, you can create a customized computer station that is tailored to your needs. Whether you need your computer station equipped with a worksurface, extra storage, or even a basic inquiry station, we have the solution you need!

Our products are designed for industrial use (production floor, packing, maintenance and repair, machine shop, etc.), but with their attractive design, they can also be used in office environments (laboratories, electronic and computer environments, etc.).

Index	Page(s)
Computer Station	156 - 157
Proposals	158 - 161
Components and Accessories	162 - 165

Computer Cabinet

The Rousseau computer cabinet ensures a protection of the computer. The fan with filter will promote proper air circulation.

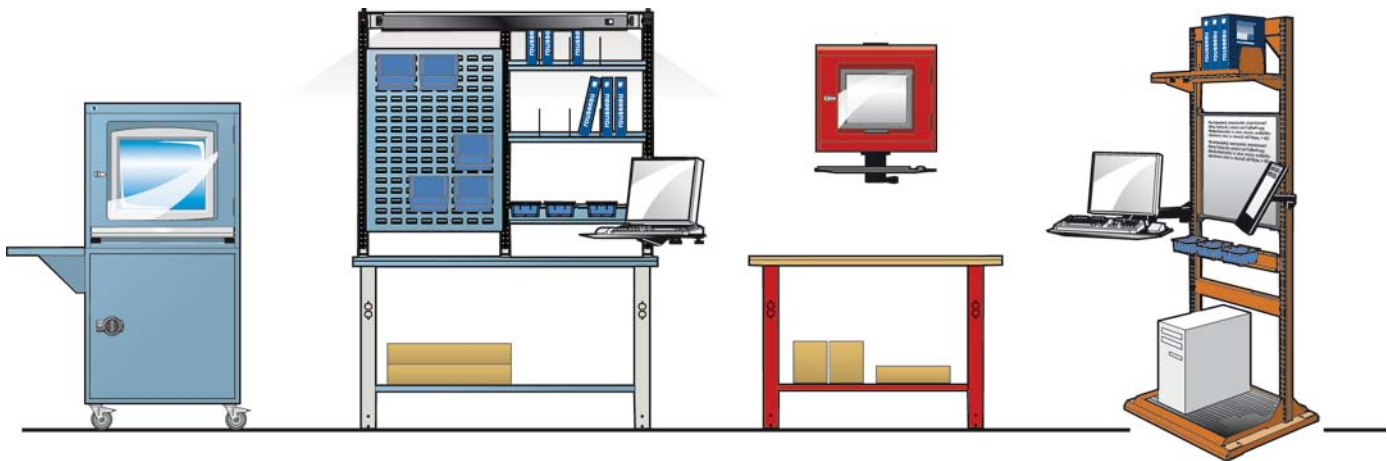
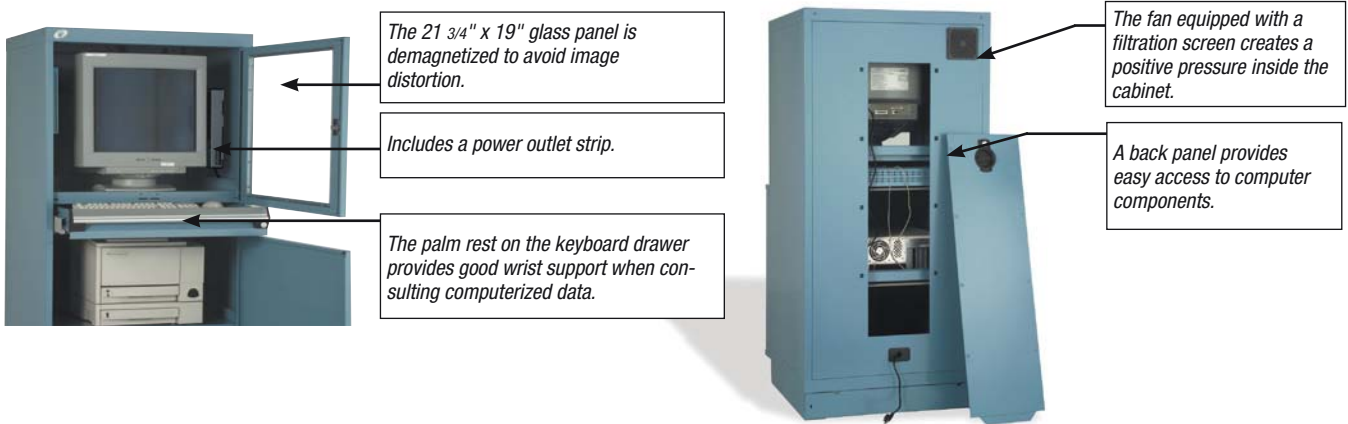

Proposals

Computer Cabinet with Adjustable Shelf

COMPUTER STATION

Stationary



R5JDG-5801

- 1 computer cabinet housing with back access panel RD31-302758L3
- 1 adjustable shelf (for monitor) RB24-3027
- 1 keyboard drawer RF31-302704L3
- 1 keyboard riser RD40-301204
- 1 adjustable shelf (for printer) RB24-3027
- 1 bottom shelf (for computer) RB25-3027
- 1 glass door for screen RD50-3022L3
- 1 single integrated door RB30-3028L3

Stationary Cabinet Includes:

- 1 recessed base (front access) RA55-302704
- 1 back cover plate RA56-3004

Mobile Cabinet Includes:

- 2-4" rigid casters RB81-01
- 2-4" swivel casters with total-lock brake system RB81-03

Product #	W x D x H
R5JDG-5801	30" x 27" x 62"
R5JDG-5821	30" x 27" x 63 1/4"

Mobile



R5JDG-5821



Computer Cabinet with Roll-Out Shelf

Stationary



R5JDG-5815

- 1 computer cabinet housing with back access panel RD31-302758L3
- 1 adjustable shelf (for monitor) RB24-3027
- 1 keyboard drawer RF31-302704L3
- 1 keyboard riser RD40-301204
- 1 front access roll-out shelf (for printer) RF50-3027
- 1 bottom shelf (for computer) RB25-3027
- 1 glass door for screen RD50-3022L3
- 1 single integrated door RB30-3028L3

Stationary Model Includes:

- 1 recessed base (front access) RA55-302704
- 1 back cover plate RA56-3004

Mobile Model Includes:

- 2-4" rigid casters RB81-01
- 2-4" swivel casters with total-lock brake system RB81-03

Product #	W x D x H
R5JDG-5815	30" x 27" x 62"
R5JDG-5837	30" x 27" x 63 1/4"

Mobile



R5JDG-5837



Computer Cabinet with Two Roll-Out Shelves

Stationary



R5JDG-5819

1 computer cabinet housing with back access panel	RD31-302758L3
1 adjustable shelf (for monitor)	RB24-3027
1 keyboard drawer	RF31-302704L3
1 keyboard riser	RD40-301204
1 front access roll-out shelf (for printer)	RF50-3027
1 front access roll-out shelf (for computer)	RF50-3027
1 glass door for screen	RD50-3022L3
1 single integrated door	RB30-3028L3

Stationary Cabinet Includes:

1 recessed base (front access)	RA55-302704
1 back cover plate	RA56-3004

Mobile Cabinet Includes:

2-4" rigid casters	RB81-01
2-4" swivel casters with total- lock brake system	RB81-03

Product #	W x D x H
R5JDG-5819	30" x 27" x 62"
R5JDG-5839	30" x 27" x 63 1/4"

Mobile



R5JDG-5839

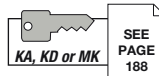

COMPUTER STATION

Workstation

Here are some of our different workstation options. Please see the "work center" section for the different accessories and configurations offered.



Computer Workstation with Compact Cabinet

LC3005C



LC3005C

1 WM double unit frame	WM11-5636
1 LCD monitor and keyboard holder	WM65-01B
1 tiltable shelf	WM20-2808
3 partial dividers	SH52-1206
1 plastic bin rail	WM28-2801
1 power outlet channel	WM40-2801
1 tackboard and marker panel	WM54-2424
1 panel bracket kit	WM50-01
4 plastic bins	RG20-040303
1 laminated wood top	WS14-6030A
1 open leg	WS20-2732
1 "L" compact cabinet	L3ABD-2808C

Product #	W x D x H
LC3005C	60" x 30" x 68"

Proposals

COMPUTER STATION

Computer Workstation with CPU Support

LC3006C



1 CPU support	WS92-01	1 power outlet channel	WM40-2801
1 laminated wood top	WS14-6030A	1 tiltable shelf	WM20-2808
1 open leg	WS20-2732	2 plastic bin rails	WM28-2801
1 "L" compact cabinet	L3ABD-2822C	2 partial dividers	SH52-1206
3 multi-purpose uprights	WM10-24	5 plastic bins	RG20-040303
2 upright cross members	WM15-28	3 plastic bins	RG20-060303
1 adjustable keyboard tray	WS90-02	Product #	W x D x H
1 LCD monitor holder	WM65-02A	LC3006C	60" x 30" x 58"

Multi-Purpose Stand

Here are some of our different multi-purpose stand options. Please see the "work center" section for the different accessories and configurations offered.

SEE
PAGES
86-123

Off-Centered Model

WMA4061

Centered Model

WMA3051

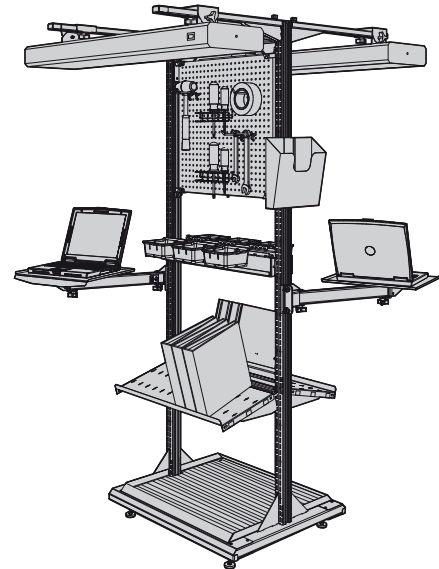
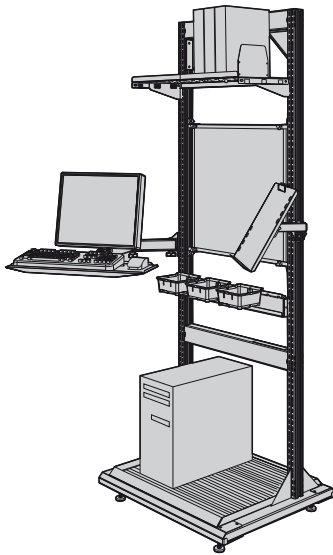

1 - 84" high off-center WM stand	WMA4001
1 LCD monitor and keyboard holder	WM65-02B
1 document holder with arm	WM70-01
1 tackboard and marker panel	WM54-2424
1 panel bracket kit	WM50-01
1 tiltable shelf	WM20-2812
2 partial dividers	SH52-1206
1 plastic bin rail	WM28-2801
4 plastic bins	RG20-060603
1 bottom shelf with rubber mat	WM83-282702
Product #	W x D x H
WMA4061	32" x 27" x 85"

1 - 84" high centered WM stand	WMA3001
2 monitor trays	WM62-01A
2 perforated panels	WM53-2424
1 panel bracket kit	WM50-01
1 document holder	WM90-01
2 plastic bin rails	WM28-2801
6 plastic bins	RG20-060603
2 tiltable shelves	WM20-2812
2 screwdriver holders	WM95-01
1 pack of 10 hooks for perforated panel	WM98-03
2 pairs of cantilever overhead supports	WM18-26
2 overhead workstation lights	WM45-48T8
1 bottom shelf with rubber mat	WM83-282701
Product #	W x D x H
WMA3051	32" x 27" x 85"

Smart Computer Cabinet

Our smart computer cabinet offers an alternative to conventional computer cabinets. You have the choice of a cabinet with or without doors, and with or without a keyboard tray.

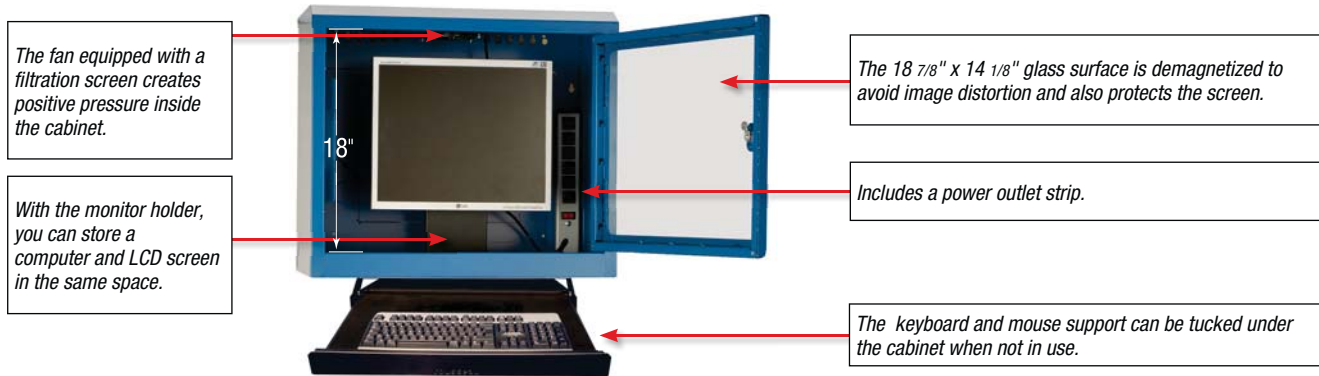

Smart Computer Cabinet with Choice of Configurations

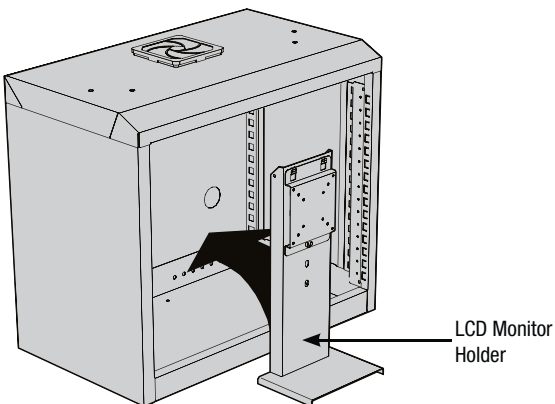

Cabinet dimensions: 24" W x 14" D x 21" H;
 Glass surface dimensions: 18 7/8" W x 14 1/8" H;
 Useable support surface: 22 1/2" W x 14 1/2" D.

Product #	Type
R5MCA-2450	Wall-mounted cabinet only
R5MCA-2451	Wall-mounted cabinet with glass door
R5MCA-2452	Wall-mounted cabinet with keyboard and mouse support
R5MCA-2453	Wall-mounted cabinet with glass door and keyboard and mouse support
R5MCA-2454	Wall-mounted cabinet with flipper door and laptop support



NOTE The wall-mounted cabinet includes the LCD monitor holder.



The RD47 support can also be installed under a RD02 cabinet to use a laptop.

Components and Accessories

Computer Cabinet

Computer Cabinet Housing with Back Panel

RD31

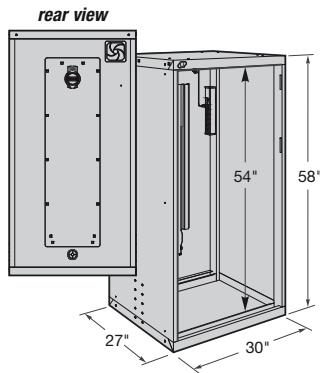

Equipped with ventilator with filtration screen;
Includes power outlet strip;
Back access panel provides easy access to computer components. Includes a lock;
Space to run wires;
Compatible with 4" and 6" casters;
Compatible with RA53 forklift base, the RA55 recessed base and base risers RB94 and RB95;
Note : It is strongly suggested to order a base (RA55, RB94 or RB95) for upright positions or for taller people.

Product #	W x D x H
RD31-302758L3	30" x 27" x 58"



COMPUTER STATION

Recessed Base

RA55

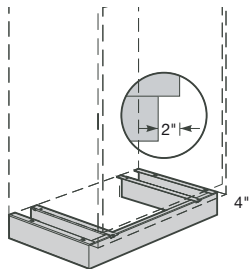

Designed to raise the height of a cabinet by 4";
Designed for moving the cabinet from the front with a forklift or pallet-jack;
Includes a removable cover plate at the front for aesthetics and in order to move the cabinet from the front;
Compatible with the RA56 rear base cover plate, offered as an option. Front cover plate included;
Front cover plate is on a straight angle to facilitate cleaning floors;
Designed to allow user to anchor the cabinet to the floor;
Compatible with leveling glides RA74;
Not compatible with casters.

Product #	W x D x H
RA55-302704	30" x 27" x 4"

Riser Base

RB95

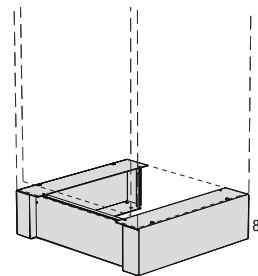

Used to raise the height of a cabinet by 8";
Provides improved ergonomics for taller people;
Installs directly under the cabinet;
Used to move the cabinet from the front with a forklift;
Compatible with leveling glides (RA74);
Compatible with the RB98 rear base cover plate, offered as an option. Front cover plate included;
Not compatible with casters.

Product #	W x D x H
RB95-302708	30" x 27" x 8"

Base Riser for Mobile Cabinet

RB94

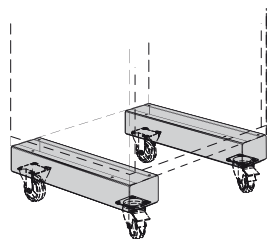

Designed to raise the height of a mobile cabinet by 4";
Allows medium height and tall people to be comfortable when working at the cabinet;
Installs directly under cabinet;
Compatible with 4" and 6" high casters.

Product #	D x H
RB94-2704	27" x 4"

Cover Plate

RA56 / RB98

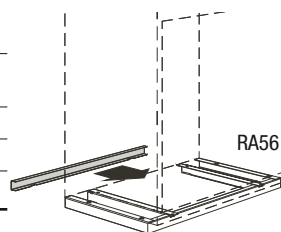

RA56 : Closes off the back of 4" recessed bases (RA55);
RB98 : Closes off the back of riser base (RB95).

Product #	W x H	For
RA56-3004	30" x 4"	RA55
RB98-3008	30" x 8"	RB95

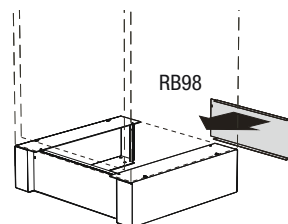

Components and Accessories

Leveling Glide Kit

RA74

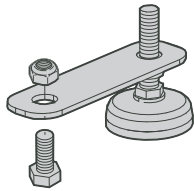

Sold in kits of 4;
Installs directly under the cabinet, without base, or under the RB95 riser base.
Serves to adjust the height of cabinet housing on uneven floor surfaces.

Product #
RA74-01

4" and 6" casters

RB81 / RB84

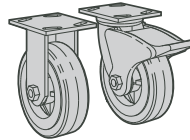

Sold in pairs;
Choice of 3 types of casters : rigid, swivel, swivel with total-lock brake system (on wheel and swivel);

4" casters: total height of 5 1/4";
6" casters: total height of 7 1/2";

Polyurethane casters (do not mark floors). Superior quality industrial casters;

The casters install directly under cabinet (without base); they are also compatible with the base riser (RB94) for mobile cabinets.

Product #	Height	Type of caster
RB81-01	4"	Rigid
RB81-02	4"	Swivel
RB81-03	4"	Swivel with total-lock brake system
RB84-01	6"	Rigid
RB84-02	6"	Swivel
RB84-03	6"	Swivel with total-lock brake system

Keyboard Drawer

RF31

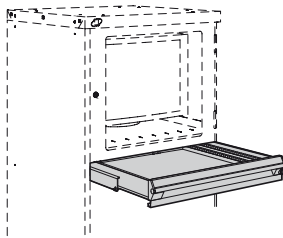

Possible to store a standard (12" deep) three-ring binder behind keyboard;

Compartments can be created by adding partitions, dividers and plastic bins;

Standard lock included;

Note : It is strongly recommended to order the RD40 keyboard riser to place keyboard and mouse in an ergonomic position.

Product #	W x D x H
RF31-302704L3	30" x 27" x 4"

SEE PAGES 151-154

KA, KD or MK
SEE PAGE 188

Keyboard Riser

RD40

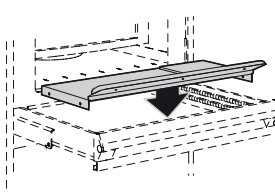

Allows user to place keyboard and mouse in an ergonomic position;

Equipped with wrist rest;

Leaves enough room to store a standard (12" deep) three-ring binder behind keyboard;

Leaves enough room to add compartments by adding partitions, dividers and plastic bins.

Product #	W x D x H
RD40-301204	30" x 12" x 4"

Roll-Out Shelf for Integrated Door

RF50

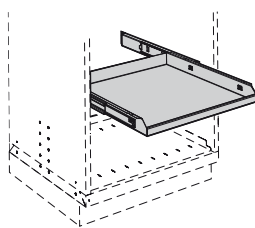

Allows storage of bulky items;
Compatible with the RB30 integrated door;
65% extension;
175 lb capacity;
Painted steel with back and side edges;
Full access to contents.

Product #	W x D
RF50-3027	30" x 27"

Adjustable Shelf

RB24

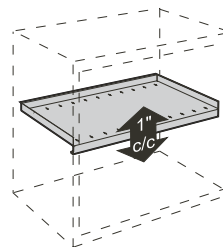

Perfect for storing bulky items;
Has edges along the sides and back to prevent items from falling into the bottom of the cabinet;
Adjustable every 1" c/c;
Up to 400 lb capacity, evenly distributed load.

Product #	W x D
RB24-3027	30" x 27"

Bottom Shelf for Cabinet

RB25

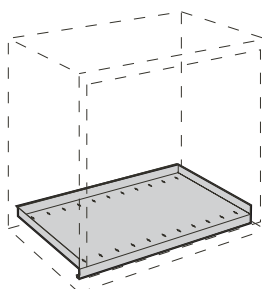

Perfect for storing bulky items;
Has edges along the sides and back to prevent items from falling into the bottom of the cabinet;
Up to 400 lb capacity, evenly distributed load.

Product #	W x D
RB25-3027	30" x 27"



Components and Accessories

COMPUTER STATION

Glass Door for Screen

RD50

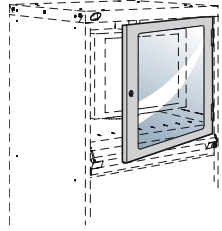

Demagnetized glass panel 21 1/4" W x 18 7/8" H to avoid image distortion;
 Factory installed on RD31 cabinet housings;
 Standard lock included.

Product #	W x H
RD50-3022L3	30" x 22"



Single Integrated Door, Solid or Glass

RB30 / RB31

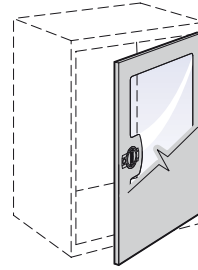

Single Integrated door : RB30;
 Single Integrated glass door : RB31;
 Compatible with the bottom shelf (RB25), the adjustable shelf (RB24) and the roll-out shelf (RF50);
 Opens 180° for full access to items stored inside;
 Factory installed on RD31 cabinet housings ;
 Standard lock included.

Product #	W x H
RB30-3028L3	30" x 28"
RB31-3028L3	30" x 28"

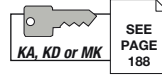

Foldaway Shelf

RC00

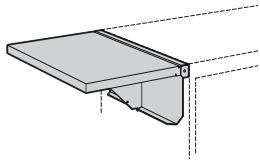

50 lb capacity (evenly distributed load);
 Rubber mat surface for added protection;
 RC01 side and back stops can be installed as an option.

Product #	W x D
RC00-152701	15" x 27"

Side and Back Stops for Foldaway Shelf

RC01

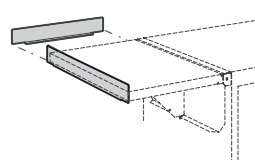

Use the 15" stop for the front or back of the shelf;
 Use the 27" stop for the sides;
 Height : 1".

Product #	Width
RC01-15	15"
RC01-27	27"

Accessories Underneath the Worksurface

Sliding Keyboard Tray

WS90-01

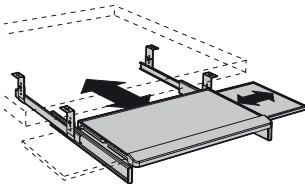

May be mounted on all surfaces;
 Mouse tray slides to the left or right side, as needed;
 Usable area : 8 1/2" x 20 1/2";
 Mouse tray : 9 3/8" x 9 1/8".

Product #	Color
WS90-01	Black

Adjustable Keyboard Tray

WS90-02

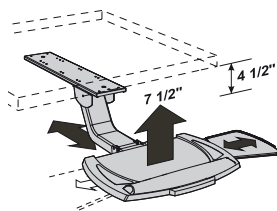

Support with articulating arm designed for use in the sit/stand position;
 May be mounted on all surfaces;
 Includes :
 - mouse tray, slides to the left or right side, as needed
 - ergonomic palm rest
 Slides under the work surface for storage.
 Sturdy construction;
 Usable area : 9 1/2" x 20 1/2";
 Mouse tray : 9 3/8" x 9".

Product #	Color
WS90-02	Black

CPU Support

WS92



May be mounted on all surfaces;
 Handle allows width of plastic side support to be adjusted;
 Adjustments accommodate computers with dimensions of 3 1/2" to 9 1/4" width by 12 1/2" to 22 1/2" height;
 Width : 8 3/8" to 11 1/2";
 Depth : 6 3/4" (8 1/2" with handle);
 Height: 18" to 26".

Product #	Color
WS92-01	Black

Computer Supports for Multi-Purpose Frames

Standard Monitor Tray

WM62 / WM64

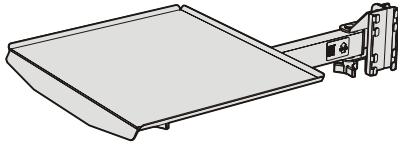

May be used to hold a computer monitor, laptop computer, electronic device or any other object;

Usable tray space : 16" W x 13 7/8" D;

Includes one 18" heavy-duty arm with single or double articulation and a non-slip rubber mat;

The double articulated model allows for increased adjusting possibilities;

Compatible with the WM63 keyboard and mouse tray;

50 lb capacity (wall mounted version: the wall and wall anchoring must be strong enough);

Color : Black;

Wall anchoring not included for the wall mounted model.

Product #	Articulating Arm	Model
WM62-01A	Single	For WM11 frame
WM62-02A	Double	For WM11 frame
WM64-01A	Single	Wall mounted
WM64-02A	Double	Wall mounted

Keyboard and Mouse Tray

WM63

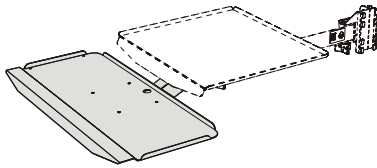

Installs on the WM62 and WM64 monitor tray with arm;

Color : Black;

Usable tray space : 23 11/16" W x 8 1/2" D.

Product #

WM63-2402

LCD Monitor Holder

WM65 / WM66

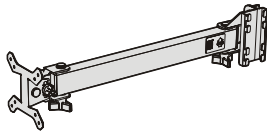

Can be used to hold the majority of LCD monitors on the market;

Screen anchor support respects VESA 75 & 100 standards;

Possible to tilt the screen;

Color : Black;

Note : Not compatible with the keyboard tray.

Product #	Articulating Arm	Model
WM65-01A	Single	For WM11 frame
WM65-02A	Double	For WM11 frame
WM66-01A	Single	Wall mounted
WM66-02A	Double	Wall mounted

LCD Monitor and Keyboard Holder

WM65 / WM66

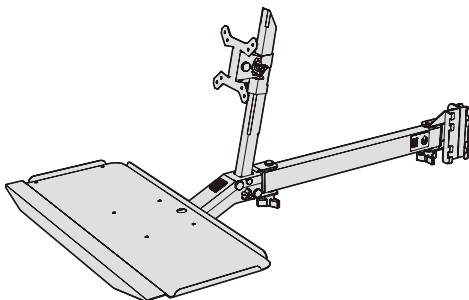

Can be used to hold the majority of LCD monitors on the market;

Screen anchor support respects VESA 75 & 100 standards;

Includes a keyboard holder, usable surface is 23 11/16" W x 8 1/2" D;

Color : Black;

Screen can be adjusted in height, and can also be tilted.

Product #	Articulating Arm	Model
WM65-01B	Single	For WM11 frame
WM65-02B	Double	For WM11 frame
WM66-01B	Single	Wall mounted
WM66-02B	Double	Wall mounted

Wall Mounted

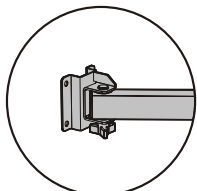

For WM11 Frame

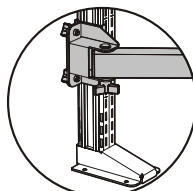

Double Articulating Arm

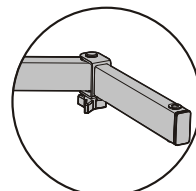

Record Storage

RECORD STORAGE



CDSA, City of Quebec

The Rousseau Advantages

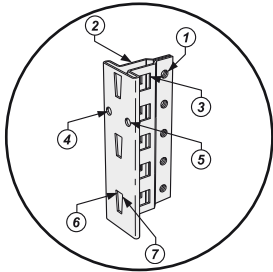

A unique and highly functional post. The common post is the cornerstone of the structure. Its unique T-shape offers up to 7 fixing zones for different applications. Plus, its hollow center makes for installation without interference between sections.



Record storage units can be combined with the Spider® industrial shelving system.

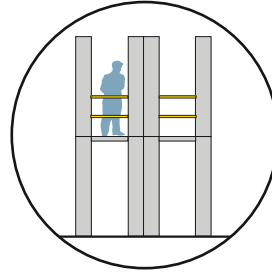

It is possible to use your vertical space to the maximum by combining the Spider® record storage system with two-level shelving.

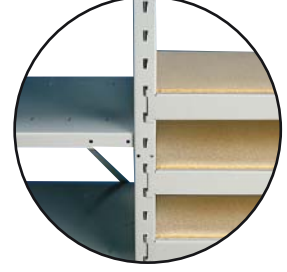

Shelves are installed with compression clips. The beams hook onto the front of the post and are designed to work with steel, wood and wire decking.

RECORD STORAGE



SRD8008

With the Rousseau record storage system, wasted space is a thing of the past. Our specially constructed shelving system was designed with the popular sizes of record storage boxes in mind. In addition, our record storage system is perfectly compatible with all of the other industrial shelving accessories, thanks to the one-of-a-kind post.

Is your need for storage space greater than you originally thought? Equipped with catwalk mezzanines and deck-over shelving, our multi-level shelving system might be just what you're looking for. Ask for help from one of our specialists, they'll find the perfect solution, just for you!

Index	Page(s)
Record Storage	166
Proposals	167
Components	168 - 169

NOTE The unique shape of the Spider® post is a Rousseau Metal Inc. trademark.

Shelving for Record Storage

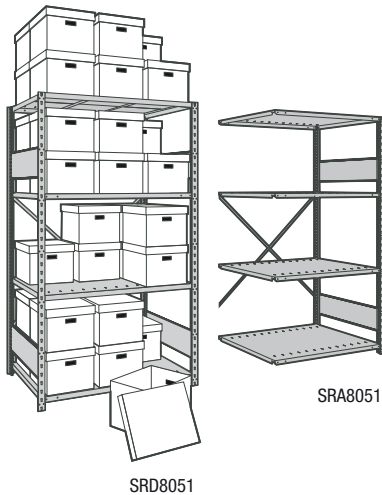

SRD8051

SRA8051

Capacity : up to 48 boxes
(each 12" W x 15" D x 10 1/4" H);

Order models for double stacking (left) for light boxes,
and models for single stacking (right) for heavier boxes;

System designed for high-rise shelving;

4 to 8 shelf levels, depending on the model;

Boxes not included;

To order a back-to-back unit, complete product number
with B.

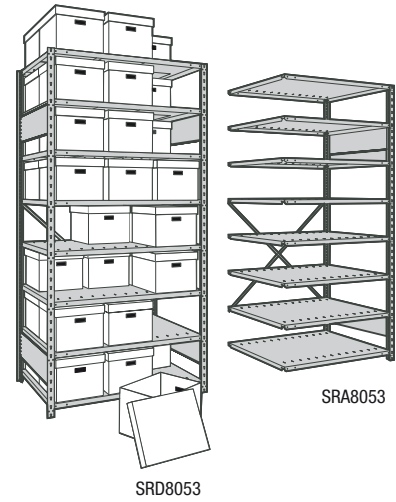

SRD8053

SRA8053

Starter	Add-on	W x D x H	No. of Boxes / Level	No. of Shelves	Total no. of Boxes / Unit	Capacity* per Shelf
Double stacked						
SRD8050_	SRA8050_	42" x 15" x 75"	6	4	24	650
SRD8051_	SRA8051_	42" x 30" x 75"	12	4	48	600
Single stacked						
SRD8052_	SRA8052_	42" x 15" x 87"	3	8	24	650
SRD8053_	SRA8053_	42" x 30" x 87"	6	8	48	600

* in pounds

Mini-Racking for Record Storage

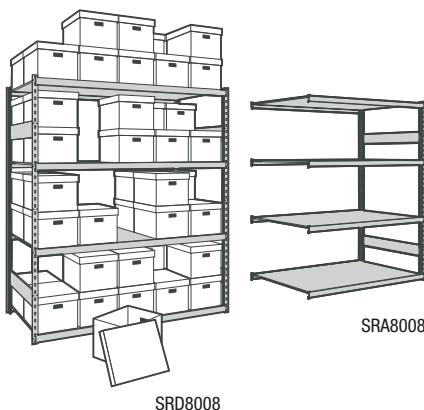

SRD8008

SRA8008

Capacity : up to 80 boxes
(each 12" W x 15" D x 10 1/4" H);

Save between 10% and 15% of shelving space
when compared to similar products offered on the market;

4 levels with medium-duty beams;

Total height of 95", boxes included, allowing for storage in spaces of 8 feet high. Height
without boxes : 75";

Boxes not included;

To order a unit with steel shelves, complete the product number with an S;

To order a unit without decking (Ex. : for use with wood panels) leave the product number as is.

Starter	Add-on	W x D x H	No. of Boxes / Level	No of Levels	Total no. of Boxes / Unit	Capacity* per Level
SRD8005_	SRA8005_	42" x 16" x 75"	6	4	24	1000
SRD8006_	SRA8006_	42" x 32" x 75"	12	4	48	1025
SRD8003_	SRA8003_	66" x 15" x 75"	10	4	40	725
SRD8007_	SRA8007_	66" x 16" x 75"	10	4	40	725
SRD8004_	SRA8004_	66" x 30" x 75"	20	4	80	700
SRD8008_	SRA8008_	66" x 32" x 75"	20	4	80	700

* in pounds

Components

Posts, Braces and Box Shelves

Shelving and Mini-Racking Posts

SR10 / SH10

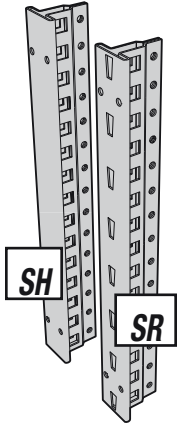

Tubular T-shape : up to 7 fixing zones;
 Perforations on sides at every 1" c/c for adjusting shelves;
 14 gauge steel;
 Choose either :
 - The universal SR10 post with the perforated surface to add Mini-Racking or two-level shelving
 - The shelving SH10 post with the smooth finish surface for enhanced appearance.

Shelving and Mini-Racking Post	SH shelving Post	Height
SR10-075	SH10-075	75"
SR10-087	SH10-087	87"
SR10-099	SH10-099	99"
SR10-111	SH10-111	111"
SR10-123	SH10-123	123"

Other heights available. Please contact your customer service representative.

NOTE
 SH post for shelving applications only

Side Panel Braces

SH34

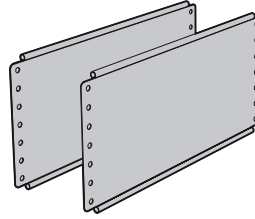

Sold in pairs;
 Allow upright assemblies to be fastened in a "ladder-like" manner for easier assembly;
 Recommendations :
 - 1 pair per upright assembly up to 99" in height
 - For upright assemblies more than 99" in height, please refer to the S58 technical sheet or contact your customer service representative.

Product #	Depth
SH34-15	15"
SH34-30	30"

Box Shelf for Shelving

SH20 / SH21

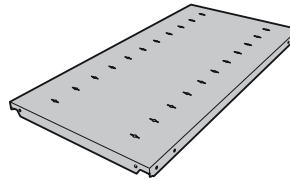

Box-type shelf with front and rear edges roll-formed and welded;
 20 gauge steel, 1 1/4" thick;
 4 sturdy and compact SH60 shelf clips included;
 Perforations for dividers at every 3" c/c.

Product #	W x D	Capacity *
SH20-4215	42" x 15"	650 lb
SH21-4230	42" x 30"	600 lb

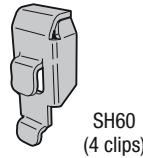

SH60 (4 clips)

*Shelving load capacity tests are based on ANSI MH28.1 Shelving Manufacturer Association (SMA) standards. Capacities incorporate a safety factor and are valid for an equally distributed load.

Back Sway Brace

SH33

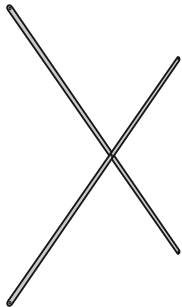

"X" shaped, factory assembled brace;
 Easy to install;
 Recommendations :
 - 1 pair per upright assembly up to 99" in height
 - 2 pairs for posts over 99" in height.
 Please refer to the S58 technical sheet or contact your customer service representative.

Product #	Width
SH33-42	42"

Back-to-Back Spacers

SR48

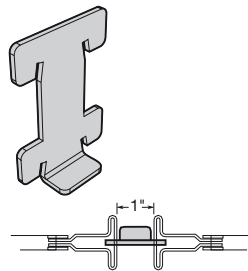

Sold in pairs;
 Used to attach two sections of Mini-Racking, back to back, with a 1" space between posts for beam adjustment.

Product #
SR48

Mini-Racking Ladder Braces

SR30

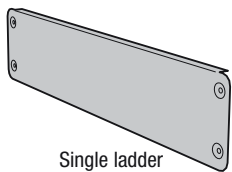

Single ladder brace for depths 15" and 16"

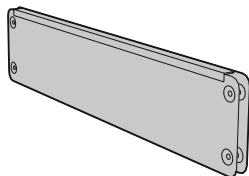

Double, interlocking ladder braces, for depths 30" and 32"

Sold in pairs;
 Recommendations :
 - 1 pair per upright assembly up to 99" in height
 - For upright assemblies more than 99" in height, please contact your customer service representative

For depths of 30" and 32", ladder braces interlock, as shown, to reinforce the structure. Pairs of ladder braces supplied with these models are double ladder braces.

Product #	Depth
SR30-15	15"
SR30-16	16"
SR30-30	30"
SR30-32	32"



COSA, City of Québec

RECORD STORAGE

Beams, Tie Bars and Wood Decking

Medium-Duty Beams for Mini-Racking

SR21

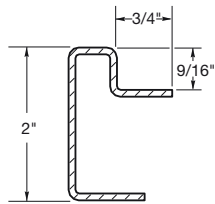

Sold in pairs;
14 gauge steel;
Attach to the front of the posts. Height adjustments every 2" c/c;
Held in place with two safety clips.

Product #	W x H
SR21-42	42" x 2"
SR21-66	66" x 2"

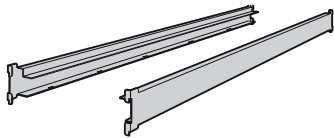

Medium-Duty Tie Bar

SR25

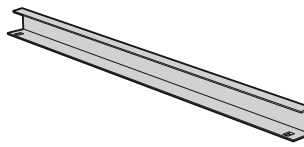

Hook to the inside of SR21 beams.

Product #	Depth
SR25-15	15"
SR25-16	16"
SR25-30	30"
SR25-32	32"



Wood Panel Dimensions and Capacities

Wood panels must be cut to the dimensions specified in this chart.

Upright assembly depth	Beam Width (capacity*)		No. of tie bars
	42"	66"	
15"	40 3/4" x 14 1/8" (1000)	64 3/4" x 14 1/8" (725)	1
16"	40 3/4" x 15 1/8" (1000)	64 3/4" x 15 1/8" (725)	1
30"	40 3/4" x 29 3/8" (1025)	64 3/4" x 29 3/8" (700)	2
32"	40 3/4" x 31 3/8" (1025)	64 3/4" x 31 3/8" (700)	2

IMPORTANT

Wood panels are not provided by Rousseau. Beams are designed for plywood or particleboard panels at least 5/8" thick.

* Shelving load capacity tests are based on ANSI MH28.2 Shelving Manufacturer Association (SMA) standards. Capacities incorporate a safety factor and are valid for an equally distributed load. Capacities are indicated in pounds.

These dimensions are suitable for Mini-Racking and back-to-back shelving.

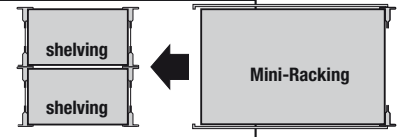

Installation Accessories

Floor Anchor Plate

SH45

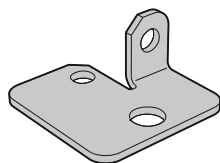

Sold individually;
Plate fastened to the post to anchor sections of shelving to the floor. Distributes load over a greater surface area and protects the floor;
12 gauge steel.
Product #
SH45

Floor Anchor Hardware Kit

SH47

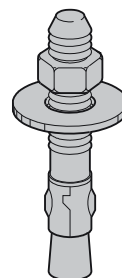

To bolt shelving to the ground;
Includes 4 cement screws.

Product #
SH47-04

Shim Plate

SH46

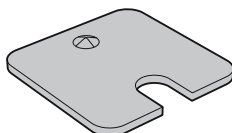

Sold individually;
Used to level shelving. Slides under the floor anchor plate;
12 or 16 gauge steel.
Product # **Thickness**
SH46-12 12 gauge (0,100")
SH46-16 16 gauge (0,060")

Wall Spacer

SR47

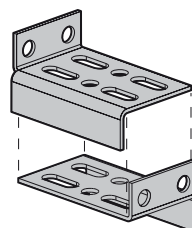

For anchoring shelving to walls;
3" to 4" adjustment;
Wall anchor hardware kit not included (holes 5/16" in diameter).

Product #
SR47-0304

Multi-Level Shelving

MULTI-LEVEL SHELVING



MULTI-LEVEL SHELVING

Experiencing lack of space? ... Before building on an addition, think about Rousseau multi-level shelving. It allows you to increase efficiency by using the space you already have to the maximum : in height, width and depth.

Our specialists will suggest solutions to get around all of the obstacles in your path : construction support beams, columns, doors, ventilation conduits, etc.

Rousseau multi-level shelving will maximize your storage by combining shelving, modular drawers and Mini-Racking and adapting it to your inventory. Store all of your parts in a small area and reduce wasted time moving through your inventory to find parts.

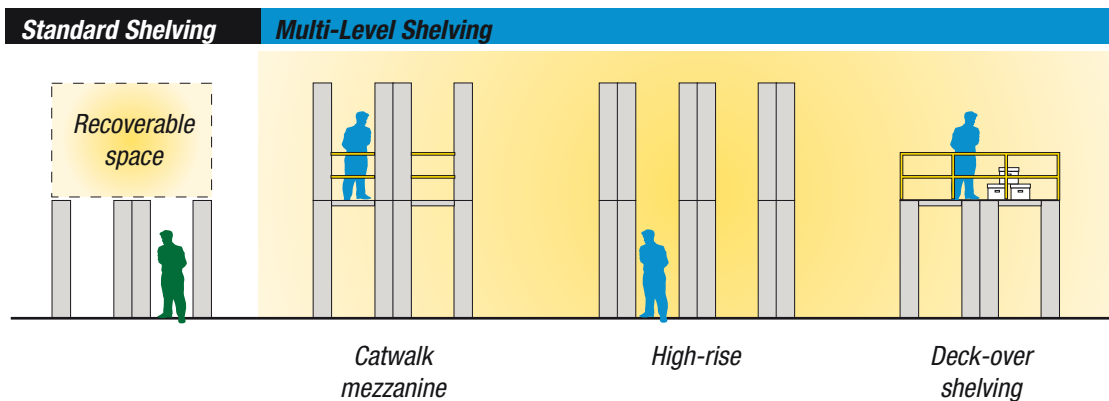

Multi-Level Shelving

MULTI-LEVEL SHELVING

Expertise that Leaves Nothing to Chance



IMPORTANT

The multi-level shelving system is subject to standards and recommendations in earthquake-prone regions. Rousseau project managers are available to assist you in determining your shelving and sway bracing for multi-level shelving system projects. Call Rousseau's sales department and request the assistance of one of our project managers.



NOTE For technical specifications, please refer to technical document S05 Multi-Level Shelving.

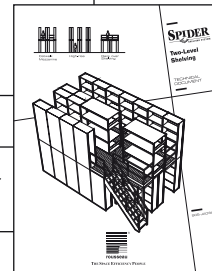

Applications

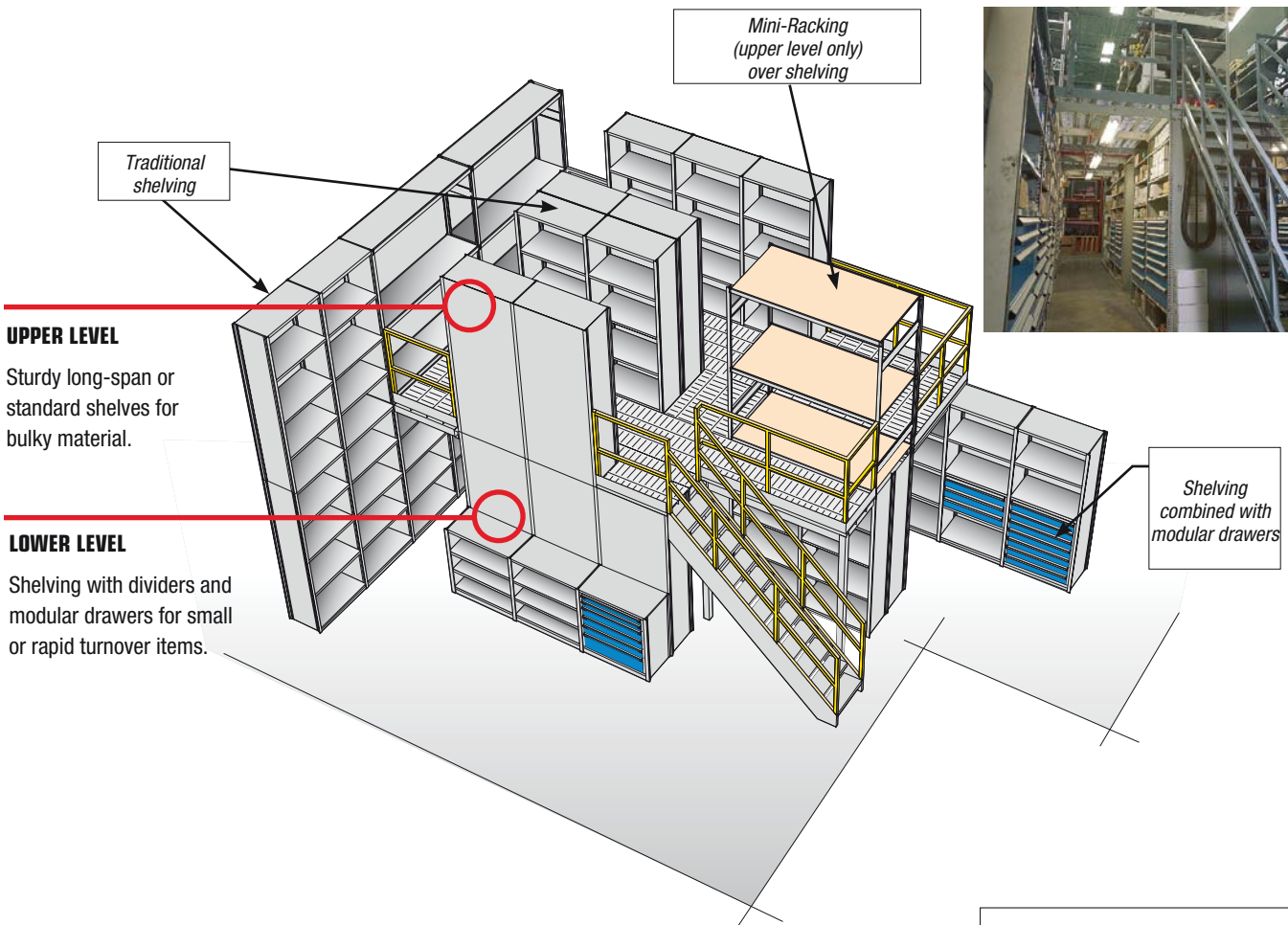

NOTE Stairs, guardrails and ramps not provided by Rousseau.

CNC Tool Storage Solutions

CNC TOOL STORAGE



CNC TOOL STORAGE SOLUTIONS

Thanks to the flexibility of the CNC line, your tools will be protected during regular handling, transportation and storage. The Rousseau CNC tool rack distinguishes itself in many ways :

By its modularity : it is compatible with the entire line of Rousseau products;

By its flexibility : offered blank or with perforations, it can adapt to any type of tool;

By its sturdiness : maximum support and stability prevents tools from falling, even when the rack is tilted;

By its ergonomics : practical, ergonomic handles make it easy to carry. Handling is made easier in the Spider® shelving and on the multi-purpose stand by the 20° inclination of the adaptors;

By its security : sturdy PVC extruded design, it can withstand blows and allows for coolant drainage, prolonging tool life.

The tool identification zone allows for quick retrieval of tools.



CNC Tool Storage Solutions

The Rousseau Advantages



Made of sturdy PVC, the extruded part of the rack protects tools against blows. Contact points between tools and the rack help prevent corrosion.



The tool rack comes with perforations to insert Taper, Straight, Sandvik Capto, HSK, KM and VDI tools. The extruded PVC component is also offered without perforations.



The tool rack, at the core of our storage system, is compatible with the entire Rousseau product line. The compact and sturdy tool rack is equipped with practical, ergonomic handles, making it easy to carry.

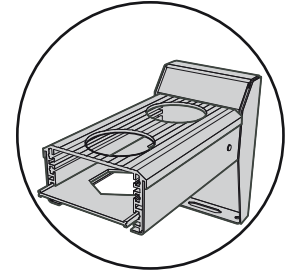

With its original two-level design, the rack offers improved support and increased stability by preventing tools from falling out, even in an inclined position.

CNC Tool Rack Integration with the Rousseau Line

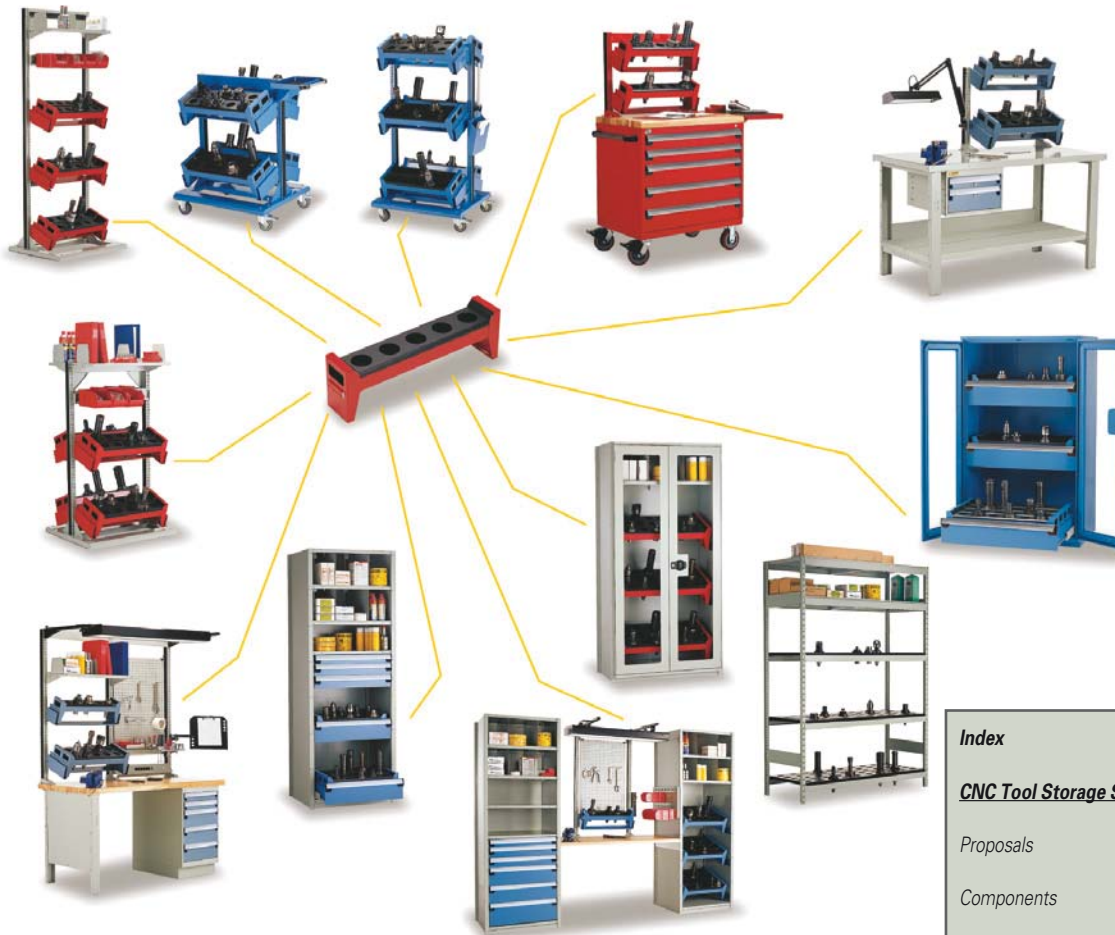

Index	Page(s)
CNC Tool Storage System	172 - 173
Proposals	174 - 175
Components	176 - 181

87" Shelving with Modular Drawers

NCS2307



NCS2307

1 - 3" drawer	RF32-302403
2 - 4" drawers	RF32-302404
2 - 7" drawers with adaptors	RF32-302407 NC54-240
5 shelves	SH20-3024
1 set of 48" mounting brackets	RE30-48
4 shelf dividers	SH50-2412
2 welded closed upright assemblies	SH12-24087
1 front base	SH28-3002
4 floor anchor plates	SH45
1 floor anchor hardware kit	SH47-04
1 back panel	SH31-3039
1 back panel	SH31-3051

Product #	W x D x H	# of racks
NCS2307	30" x 24" x 87"	8

NOTE Tool racks must be ordered separately.

SEE PAGE 176

NOTE Drawer partitioning is not included and must be ordered separately.

SEE PAGES 132-155

Modular Cabinet with Drawers

NCM0949



NCM0949

1 cabinet with one-at-a-time mechanism	RA30-362458A
1 - 2" forklift base	RA52-362402
3 - 7" drawers	RF31-362407
3 pairs of tool rack adaptors	NC54-2401

Product #	W x D x H
NCM0949	36" x 24" x 60"

NOTE Tool racks must be ordered separately.

SEE PAGE 176

Mobile Cart



NCW0106

1 mobile cart with 4" casters	WMA5002
1 shelf with handle	WM84-081401
4 double adaptors for WM	NC50-2802

Product #	W x D x H
NCW0106	32" x 27" x 41 1/4"

NOTE Tool racks must be ordered separately.

SEE PAGE 176

75" Shelving with Adaptors

NCS4114



NCS4114

3 shelves	SH20-3618
3 pairs of tool rack adaptors	NC51-1801
2 welded closed upright assemblies	SH12-18075
1 front base	SH28-3602
4 floor anchor plates	SH45
1 floor anchor hardware kit	SH47-04
2 back panel	SH31-3639
2 shelf dividers	SH50-1812

Product #	W x D x H	# of racks
NCS4114	36" x 18" x 75"	9

NOTE Tool racks must be ordered separately.

SEE PAGE 176

! Shelving with drawers must be anchored to the floor (anchor kit included).

Mobile Cabinet

NCM8185



NCM8185

1 cabinet with standard lock	RA30-362430L3
1 laminated wood top	WS14-3624A
1 pair of 6" rigid casters	RB84-01
1 pair of 6" swivel casters with total-lock brake system	RB84-03
1 side handle	RB90-24
2 drawers with integrated lock-in mechanism	RF31-362404A
3 drawers with integrated lock-in mechanism	RF31-362406A
1 single WM frame	WM11-2824
1 foldaway shelf	RC00-152401
2 standard WM tool rack adaptors	NC50-2801

Product #	W x D x H
NCM8185	36" x 24" x 61 1/2"

KA, KD or MK

SEE PAGE 188

NOTE Tool racks must be ordered separately.

SEE PAGE 176

NOTE Drawer partitioning is not included and must be ordered separately.

SEE PAGES 132-155

NCW0106



Workstation with Multi-Purpose Frame

NCW0096



NCW0096

Top section :

1 double WM unit frame	WM11-5648
1 tiltable shelf	WM20-2812
3 partial dividers	SH52-1206
1 power outlet channel	WM40-2801
1 document holder with arm	WM70-01
1 perforated panel	WM53-2424
1 panel bracket kit	WM50-01
1 double back single hooks (packs of 10)	WM98-03
1 overhead workstation light	WM45-48T8
1 WM tool rack	WM30-01
2 WM upright adaptors :	
-1 single	NC50-2801
-1 double	NC50-2802
1 pair of cantilever overhead supports	WM18-26

Bottom section :

1 laminated wood top	WS14-6030A
1 open leg	WS20-2732
1 side panel	WS62-2728
1 "L" compact cabinet	L3ABD-2814C

Product #	W x D x H
NCW0096	60" x 30" x 80"

NOTE

Tool racks must be ordered separately.

SEE PAGE 176

Stationary Multi-Purpose Stand

NCW0283



NCW0283

1 multi-purpose stand with leveling glides	WMA1001
4 WM adaptors	NC50-2802
2 plastic bin rails	WM28-2801
2 tiltable shelves	WM20-2812
6 partial dividers	SH52-1206
Product #	
W x D x H	
NCW0283	32" x 27" x 54"

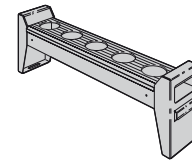

NOTE

Red plastic bins are not sold by Rousseau.

NOTE

CNC tool racks are not included in the models and must be ordered separately.

SEE PAGE 176

Mini-Racking

NCS6078



NCS6078

5 pairs of heavy-duty beams	SR22-60
2 welded Mini-racking uprights	SR13-240872
5 heavy-duty tie bars	SR27-24
2 steel decking levels :	
- 4 shelves	SR40-1824
- 2 shelves	SR40-2424
Capacity per level of steel decking:	1925 lb
Capacity per level of PVC decking:	1000 lb
Product #	
W x D x H	
NCS6078	60" x 24" x 87"

NOTE

The three decking units with perforated PVC shelves for CNC tools are not included and must be ordered separately.

SEE PAGE 181



Components

Tool Racks

Tool Rack



NC10 / NC12

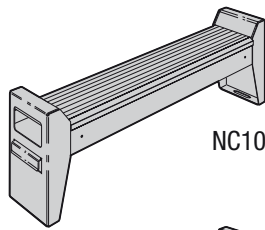

NC10

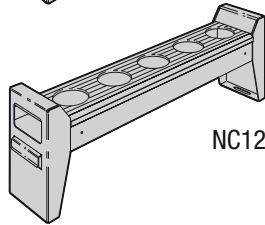

NC12

Offered with blank or perforated surface;

Made of sturdy PVC, the extruded part of the rack protects tools against shocks, corrosion and blows;

Offered in 30" and 36" wide;

The identification zone allows for quick retrieval of tools;

Compatible with WM11 (or 2 WM10 uprights and 1 WM15 cross member) and WMA units with the NC50 adaptor;

Compatible with WM35 with the NC50 adaptors;

Compatible with modular drawers : (RF31/RF32/RF33/RF34)	30" W x 21" D, 30" W x 24" D, 30" W x 27" D,	36" W x 18" D, 36" W x 24" D, with the NC54 adaptors;
--	--	---

Compatible with Spider® shelving units :	30" W x 24" D, 36" W x 18" D,	36" W x 24" D, with the NC51 adaptors.
--	----------------------------------	---

IMPORTANT

36" wide CNC tool racks are not compatible with the WM structure.

The number of tools that a tool rack or a PVC shelf can hold varies according to tool diameter and the length of extruded surfaces. The number of holes specified in the chart indicates the number of perforations per extruded surface.

Tool racks and PVC shelves must be ordered separately from proposed models. The following chart gives the product number that matches your tool type.

TOOL TYPE	SHELVING- MULTI-PURPOSE UPRIGHTS AND FRAMES- CABINETS			
	30" tool rack	# of holes	36" tool rack	# of holes
Blank rack	NC10-3000	—	NC10-3600	—
Taper 30	NC12-3001	10	NC12-3601	12
Taper 40	NC12-3003	7	NC12-3603	8
Taper 50	NC12-3005	5	NC12-3605	6
3/4" Straight	NC12-3010	20	NC12-3610	24
1" Straight	NC12-3011	20	NC12-3611	24
1 1/4" Straight	NC12-3013	20	NC12-3613	24
1 1/2" Straight	NC12-3015	8	NC12-3615	10
1 3/4" Straight	NC12-3016	8	NC12-3616	10
2" Straight	NC12-3018	6	NC12-3618	7
2 1/4" Straight	NC12-3019	6	NC12-3619	7
2 1/2" Straight	NC12-3021	6	NC12-3621	7
C4 Sandvik Capto	NC12-3031	22	NC12-3631	26
C5 Sandvik Capto	NC12-3032	10	NC12-3632	12
C6 Sandvik Capto	NC12-3033	7	NC12-3633	8
HSK 32 (A-C-E)	NC12-3041	22	NC12-3641	26
HSK 40 (A-C-E)	NC12-3042	22	NC12-3642	26
HSK 50 (A-C-E)	NC12-3043	10	NC12-3643	12
HSK 63 (A-C-E)	NC12-3044	7	NC12-3644	8
HSK 80 (A-C-E)	NC12-3045	5	NC12-3645	6
HSK 100 (A-C-E)	NC12-3046	4	NC12-3646	5
32 KM	NC12-3050	22	NC12-3650	26
40 KM	NC12-3051	22	NC12-3651	26
50 KM	NC12-3052	10	NC12-3652	12
63 KM	NC12-3053	7	NC12-3653	8
VDI 30 mm	NC12-3060	6	NC12-3660	7
VDI 40 mm	NC12-3061	5	NC12-3661	6
VDI 50 mm	NC12-3062	4	NC12-3662	5
Exact dimensions	25 1/4" W x 5" D x 7 7/8" H		31 1/4" W x 5" D x 7 7/8" H	



CNC TOOL STORAGE

Adaptors for Tool Rack

WM Adaptor

NC50

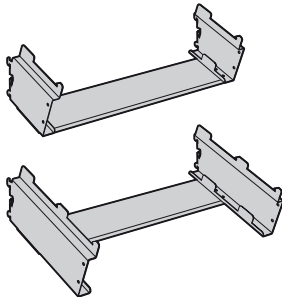

Tool rack adaptor for use with the NC10-30XX and NC 30XX in the WM11 (or 2 WM10 uprights and 1 WM15 cross member) or WMA structure,

SEE PAGE 113

Tool rack adaptor for use with the NC10-30XX and NC 30XX in the WM35;

SEE PAGE 122

The side security notches in the WM adaptor for uprights ensure tool rack stability;

Inclined 20° for easy access to tools;

Single or double model holds one or two 30" tool racks;

Easy assembly, no tools required.

Product #	Type
NC50-2801	Single
NC50-2802	Double



Adaptors for Shelving

NC51

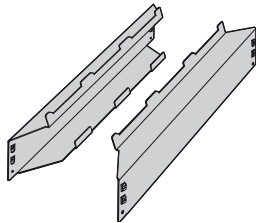

Sold in pairs;

Tool rack adaptor for use with NC10 and NC12 in 30" x 24", 36" x 18" and 36" x 24" Spider® shelving;

SEE PAGE 179

Inclined 20° for easy access to tools;

Can hold 3 to 4 NC10 or NC12 tool racks;

Adaptor compatible with Spider® shelving unit only;

Easy assembly, no tools required.

Product #	Depth	# of Racks
NC51-1801	18"	3
NC51-2401	24"	4



Adaptors for Drawers

NC54

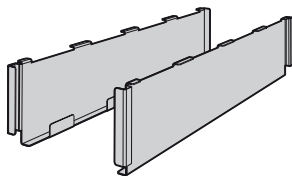

Sold in pairs;

Tool rack adaptors for use with NC10 and NC12 in 30" x 21", 30" x 24", 30" x 27", 36" x 18" and 36" x 24" modular drawers (RF31 / RF32 / RF33 / RF34);

SEE PAGES 134-135 178

Prevent tool racks from tipping when opening or closing drawer;

Can hold 3 to 4 NC10 and NC12 tool racks;

The adaptor for drawers and the tool rack may be installed in a 7" drawer only or in 10", 12" and 14" drawers for CNC tools;

Easy assembly, no tools required.

Product #	Depth	# of Racks
NC54-1801	18"	3
NC54-2101	21"	3
NC54-2401	24"	4
NC54-2701	27"	4

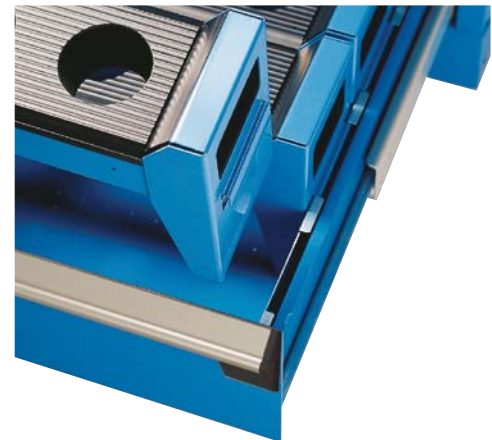

Components

Drawers and Drawers Accessories

Heavy-Duty Drawer for CNC Tools

RF33 / RF34

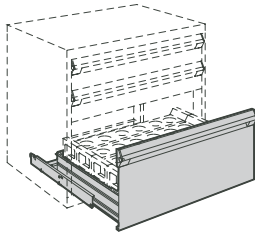

Heavy-duty drawer for cabinet : RF33;
Heavy-duty drawer for shelving : RF34;
Full-faced door facilitates taking NC10 and NC12 in and out of the drawers;

Available in : 10", 12" and 14" high;

When ordering, add the height of the drawer to the number. Ex. : RF33-302714.

Product #	W x D	Application
RF33-3021	30" x 21"	cabinet
RF33-3027	30" x 27"	cabinet
RF33-3618	36" x 18"	cabinet
RF33-3624	36" x 24"	cabinet
RF34-3024	30" x 24"	shelving*
RF34-3618	36" x 18"	shelving*
RF34-3624	36" x 24"	shelving*

*Mounting brackets are required to install draw in shelving.

NOTE Adaptors must be ordered separately.

SEE PAGE 177

SEE PAGE 83

Groove Tray

RG35

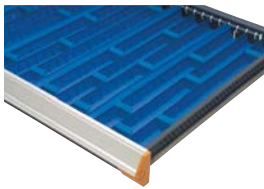

Useful in storing and protecting long objects such as drill bits, borers, sockets, lathe parts, files, tools, etc.;

Blue for easy identification of objects;

Designed for 3" H and 4" H drawers;

Compatible with partitions, dividers and plastic bins;

Available nominal depths : 18", 21", 24" and 27";

When ordering, add the depth of the drawer to the groove tray number.
Ex. : RG35-062425.

Product #	Divider #
RG35-04_10	RG39-10
RG35-06_10	RG39-10
RG35-04_15	RG39-15
RG35-06_15	RG39-15
RG35-06_25	RG39-25

Protection Foam

RG41

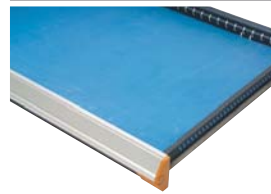

Protects stored materials;

Blue foam, 1/4" thick;

Note : partitions and dividers cannot be used in drawers where this foam is installed.

Product #	W x D
RG41-3021-01	30" x 21"
RG41-3024-01	30" x 24"
RG41-3027-01	30" x 27"
RG41-3618-01	36" x 18"
RG41-3624-01	36" x 24"

Foam for Tools

RG42



Oil-resistant and non absorbent;

1 blue foam, 1/4" thick ;

1 black self-adhesive foam, 1/2" thick ;

Sold without cut-outs.

Product #	W x D
RG42-3021-01	30" x 21"
RG42-3024-01	30" x 24"
RG42-3027-01	30" x 27"
RG42-3618-01	36" x 18"
RG42-3624-01	36" x 24"



For custom cut-outs,

SEE PAGE 189

Foam for Collets

RG43

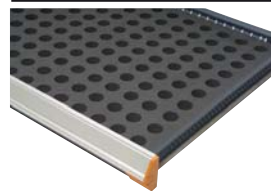

Oil-resistant and non absorbent;

1" thick black foam;

Sold without cut-outs.

Product #	W x D
RG43-3021-01	30" x 21"
RG43-3024-01	30" x 24"
RG43-3027-01	30" x 27"
RG43-3618-01	36" x 18"
RG43-3624-01	36" x 24"



For custom cut-outs,

SEE PAGE 189

Plastic Bin



RG20



Simplify storing, moving and managing small items. Light-weight and resistant;

Designed for 3" and 4" high drawers;

45° angle for easy identification of bin contents and removal of bins;

Compatible with louvered panels (SH65, SH66 and WM55) and plastic bin rails (SH62 and WM28);

Compatible with the following accessories : partitions, dividers and groove trays;

6" bins can be partitioned.

Dimensions			Bin	Product # Partition	Divider
W	D	H			
3"	3"	2"	RG20-030302	-	-
4"	3"	2"	RG20-040302	-	-
6"	3"	2"	RG20-060302	RG22-0302	-
6"	6"	2"	RG20-060602	RG22-0602	RG24-0602
3"	3"	3"	RG20-030303	-	-
4"	3"	3"	RG20-040303	-	-
6"	3"	3"	RG20-060303	RG22-0303	-
6"	6"	3"	RG20-060603	RG22-0603	RG24-0603

CNC TOOL STORAGE

Spider® Shelving Components

Starter Unit of Shelving

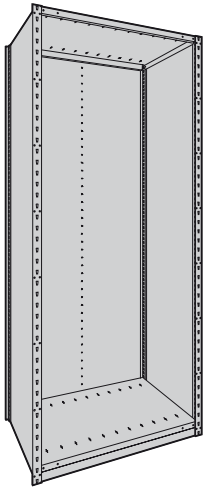

2 welded closed uprights	SR12
2 box shelves	SH20
2 back panels	SH31
1 front base	SH28

Product #	W x D x H
NCS0051	30" x 24" x 75"
NCS0052	30" x 24" x 87"
NCS0053	36" x 18" x 75"
NCS0054	36" x 18" x 87"
NCS0055	36" x 24" x 75"
NCS0056	36" x 24" x 87"

Add-On Unit of Shelving

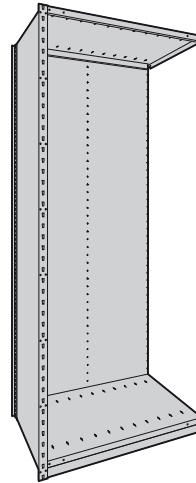

1 welded closed upright	SR12
2 box shelves	SH20
2 back panels	SH31
1 front base	SH28

Product #	W x D x H
NCS0062	30" x 24" x 75"
NCS0063	30" x 24" x 87"
NCS0064	36" x 18" x 75"
NCS0065	36" x 18" x 87"
NCS0066	36" x 24" x 75"
NCS0067	36" x 24" x 87"

Box Shelf

SH20

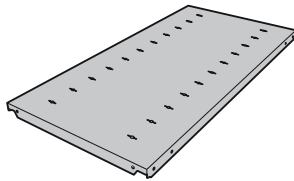

Box-type shelf with roll-formed and welded front and rear edges;

20-gauge steel. 1 1/4" thick;

4 sturdy and compact SH60 shelf clips included;

Perforations for dividers every 3" c/c.

Product #	W x D
SH20-3024	30" x 24"
SH20-3618	36" x 18"
SH20-3624	36" x 24"

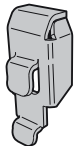

SH60
(4 hooks)

IMPORTANT

Refer to N50 tech sheet for Tool Racks and Decking to learn about recommended layouts based on tool height and intended use.

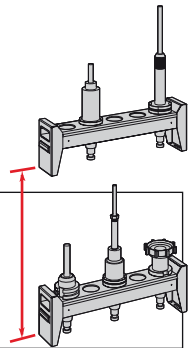

IMPORTANT

Multi-level shelving is not recommended if first-level shelving contains only tool racks and two shelves.



NCS8003



NCS2307

NOTE

Tool racks must be ordered separately.

SEE
PAGE
176

Components

Mini-Racking Components

These models are designed to receive steel shelves and decking for CNC tools. They include one tie bar per "long-span" level.

48" wide models or less have medium-duty beams and tie bars.
60" wide and 72" models wide have heavy-duty beams and tie bars.

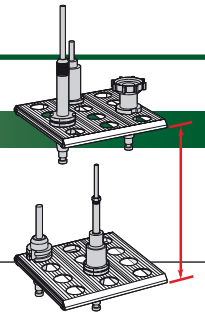

IMPORTANT

Refer to N50 tech sheet for Tool Racks and Decking to learn about recommended layouts based on tool heights and intended use.

Starter Unit



D	H	# of levels	Width		
			48"	60"	72"
18"	75"	4	NCS6070	NCS6072	NCS6074
18"	75"	5	NCS6080	NCS6082	NCS6084
24"	75"	4	NCS6071	NCS6073	NCS6075
24"	75"	5	NCS6081	NCS6083	NCS6085
CAPACITY PER LEVEL			1000 lb	1925 lb	1600 lb

Add-On Unit

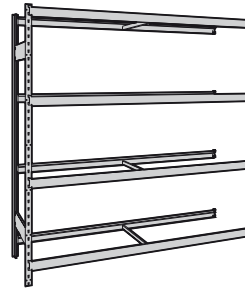

D	H	# of levels	Width		
			48"	60"	72"
18"	75"	4	NCS6092	NCS6076	NCS6094
18"	75"	5	NCS6086	NCS6088	NCS6090
24"	75"	4	NCS6093	NCS6077	NCS6095
24"	75"	5	NCS6087	NCS6089	NCS6091
CAPACITY PER LEVEL			1000 lb	1925 lb	1600 lb

NOTE

For PVC decking capacity,

SEE PAGE 181

Steel Decking

SR40



Steel decking improves shelf strength;

SR40 decking may be combined with CNC tool decking on the same level.



ATTENTION

To order, depending on unit dimensions and for each row of shelving, order the appropriate number of shelves and the product number(s) specified in the chart.

Upright Assembly Depths	Beam Width					
	48"		60"		72"	
	Qty Required	Product #	Qty Required	Product #	Qty Required	Product #
18"	2	SR40-2418	+ 2 1	SR40-1818 SR40-2418	3	SR40-2418
24"	2	SR40-2424	+ 2 1	SR40-1824 SR40-2424	3	SR40-2424

Label Holder

NC32

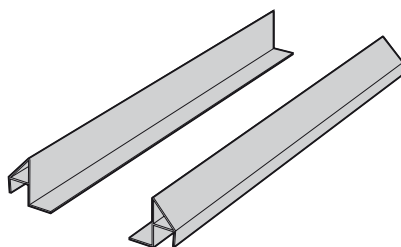

Useful for identifying your tools;

Sold for decking units combined with NC30, NC31 or SR40 shelves (included with NC33 and NC34 decking units);

Compatible with SR40 decking;

Polished look.

Product #	W x H
NC32-4801	48" x 1"
NC32-6001	60" x 1"
NC32-7201	72" x 1"



PVC Decking for CNC Tools

NC30 / NC31 / NC33 / NC34

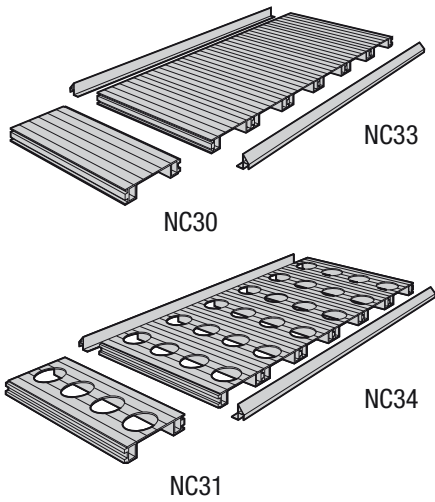

Platform offered with perforated surface (NC31 and NC34) or blank (NC30 and NC33);

Offered in 6" strips : NC30 and NC31;

Offered in a model representing a level of Mini-Racking of 48", 60" and 72" : NC33 and NC34. The model numbers for the perforated platform must be accompanied by a tool code;

Made of sturdy PVC, the extruded part of the rack protects tools against shocks, corrosion and blows;

PVC shelf (NC30/NC31) capacity for 18" D : 75 lb;

PVC shelf (NC30/NC31) capacity for 24" D : 100 lb;

The PVC shelf can be coupled with SR40 steel decking on the same level;

The 6" wide platform does not come with label holder;

48", 60" and 72" wide decking includes an NC32 label holder.

Upright Assembly Depths	Type of Surface	Unit Width	Beam Width		
		6"	48"	60"	72"
18"	Blank	NC30-1800	NC33-481800	NC33-601800	NC33-721800
	Perforated	NC31-18__	NC34-4818__	NC34-6018__	NC34-7218__
24"	Blank	NC30-2400	NC33-482400	NC33-602400	NC33-722400
	Perforated	NC31-24__	NC34-4824__	NC34-6024__	NC34-7224__

PVC shelves must be ordered separately from proposed models. The following chart gives the product number that matches your tool type.

To find out the number of holes in a platform with perforated shelves, multiply the number of perforated shelves in your platform by the number of holes in a NC31 shelf.

The number of tools that a PVC shelf can hold varies according to tool diameter and to the length of extruded surfaces. The number of holes specified in the chart indicates the number of perforations per extruded surface.



ATTENTION

To order, PVC decking model numbers must be completed by adding the tool code.

EXAMPLE NC34-4818__

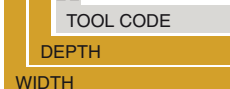

TOOL TYPE	MINI-RACKING				Tool code
	18" PVC shelf	# of holes	24" PVC shelf	# of holes	
Blank rack	NC30-1800	—	NC30-2400	—	00
Taper 30	NC31-1801	8	NC31-2401	10	01
Taper 40	NC31-1803	7	NC31-2403	9	03
Taper 50	NC31-1805	4	NC31-2405	5	05
3/4" Straight	NC31-1810	14	NC31-2410	18	10
1" Straight	NC31-1811	14	NC31-2411	18	11
1 1/4" Straight	NC31-1813	14	NC31-2413	18	13
1 1/2" Straight	NC31-1815	5	NC31-2415	7	15
1 3/4" Straight	NC31-1816	5	NC31-2416	7	16
2" Straight	NC31-1818	4	NC31-2418	5	18
2 1/4" Straight	NC31-1819	4	NC31-2419	5	19
2 1/2" Straight	NC31-1821	4	NC31-2421	5	21
C4 Sandvik Capto	NC31-1831	18	NC31-2431	24	31
C5 Sandvik Capto	NC31-1832	7	NC31-2432	9	32
C6 Sandvik Capto	NC31-1833	7	NC31-2433	9	33
HSK 32 (A-C-E)	NC31-1841	18	NC31-2441	24	41
HSK 40 (A-C-E)	NC31-1842	18	NC31-2442	24	42
HSK 50 (A-C-E)	NC31-1843	8	NC31-2443	10	43
HSK 63 (A-C-E)	NC31-1844	5	NC31-2444	7	44
HSK 80 (A-C-E)	NC31-1845	4	NC31-2445	5	45
HSK 100 (A-C-E)	NC31-1846	3	NC31-2446	4	46
32 KM	NC31-1850	18	NC31-2450	24	50
40 KM	NC31-1851	18	NC31-2451	24	51
50 KM	NC31-1852	8	NC31-2452	10	52
63 KM	NC31-1853	5	NC31-2453	7	53
VDI 30 mm	NC31-1860	7	NC31-2460	9	60
VDI 40 mm	NC31-1861	4	NC31-2461	5	61
VDI 50 mm	NC31-1862	3	NC31-2462	4	62

Automotive Storage Rack

AUTOMOTIVE



SPECIALIZED AUTOMOTIVE STORAGE

For some years now, Rousseau has been developing a system that offers a complete and integrated storage solution for the automotive industry. Whatever your needs, we are able to provide a heavy-duty and aesthetically pleasing option for even the most discerning automotive dealer.

What we offer is more than a simple product. It is a complete system to help you organize your parts department. Included are bumper and pipe racks, sheet metal racks, battery and tire racks, etc.

The variety and flexibility of the Rousseau line represents a great advantage. It is a system that will grow with your needs. We are proud to be able to help answer the needs of any customer, big or small, and always offer the same quality and service which has become our trademark.

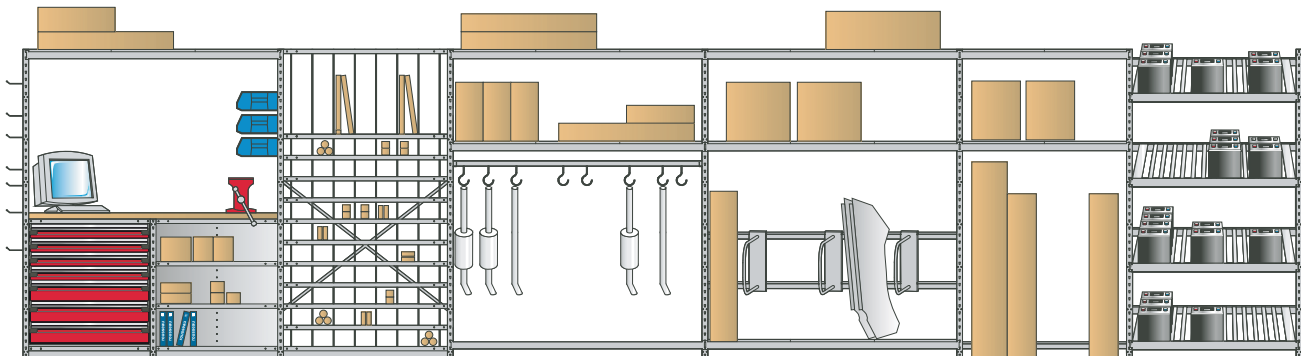

Automotive Storage Rack

AUTOMOTIVE

One Solution for Each Application

The strength of our system is that it adapts to your environment and evolves with your needs.

With the numerous dimensions and variety of accessories offered, you can create your own customized layout to complement the structure of your building.

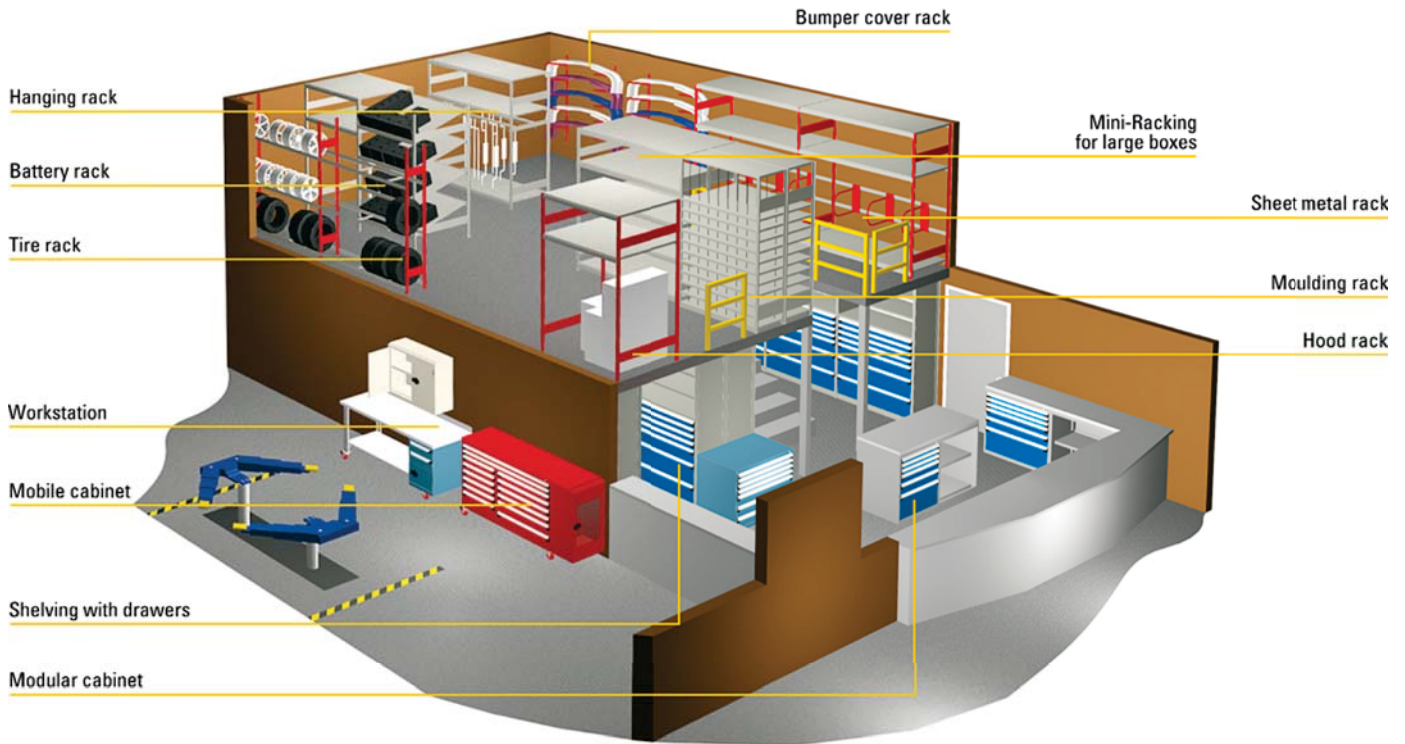

<i>Index</i>	<i>Page(s)</i>
<u>Automobile Storage Rack</u>	182- 183
<i>Proposals</i>	184- 186
<i>Components</i>	187

Some Accomplishments



Proposals

AUTOMOTIVE

Single Hanging Rack



SRP0404

2 welded Mini-Racking upright assemblies;
3 steel decking levels;

The 60" and 72" W proposals include medium-duty beams and the 96" W proposals include heavy-duty beams;

To order an add-on unit, complete product number with A;

To order bolted uprights, order SRPX5XX instead of SRPX4XX.

Product #	W x D x H	# of rails (hooks)
SRP1405_	60" x 36" x 75"	1 (15)
SRP1406_	60" x 36" x 75"	2 (30)
SRP1403_	72" x 36" x 75"	1 (15)
SRP1404_	72" x 36" x 75"	2 (30)
SRP1407_	96" x 36" x 75"	1 (25)
SRP1408_	96" x 36" x 75"	2 (45)
SRP0405_	60" x 36" x 87"	1 (15)
SRP0406_	60" x 36" x 87"	2 (30)
SRP0403_	72" x 36" x 87"	1 (15)
SRP0404_	72" x 36" x 87"	2 (30)
SRP0407_	96" x 36" x 87"	1 (25)
SRP0408_	96" x 36" x 87"	2 (45)

Double Hanging Rack



SRP2404

2 welded Mini-Racking upright assemblies;
3 steel decking levels;

The 60" and 72" W proposals include medium-duty beams and the 96" W proposals include heavy-duty beams;

To order an add-on unit, complete product number with A;

To order bolted uprights, order SRPX5XX instead of SRPX4XX.

Product #	W x D x H	# of rails (hooks)
SRP3405_	60" X 36" X 75"	2 (30)
SRP3406_	60" X 36" X 75"	4 (60)
SRP3403_	72" X 36" X 75"	2 (30)
SRP3404_	72" X 36" X 75"	4 (60)
SRP3407_	96" X 36" X 75"	2 (50)
SRP3408_	96" X 36" X 75"	4 (90)
SRP2405_	60" X 36" X 87"	2 (30)
SRP2406_	60" X 36" X 87"	4 (60)
SRP2403_	72" X 36" X 87"	2 (30)
SRP2404_	72" X 36" X 87"	4 (60)
SRP2407_	96" X 36" X 87"	2 (50)
SRP2408_	96" X 36" X 87"	4 (90)

Single Carpet Rack



SRP0473

2 welded Mini-Racking upright assemblies;
3 steel decking levels;

The 60" and 72" W proposals include medium-duty beams and the 96" W proposals include heavy-duty beams;

To order an add-on unit, complete product number with A;

To order bolted uprights, order SRPX5XX instead of SRPX4XX.

Product #	W x D x H	# of rails
SRP1475_	60" X 36" X 75"	1
SRP1476_	60" X 36" X 75"	2
SRP1473_	72" X 36" X 75"	1
SRP1474_	72" X 36" X 75"	2
SRP1477_	96" X 36" X 75"	1
SRP1478_	96" X 36" X 75"	2
SRP0475_	60" X 36" X 87"	1
SRP0476_	60" X 36" X 87"	2
SRP0473_	72" X 36" X 87"	1
SRP0474_	72" X 36" X 87"	2
SRP0477_	96" X 36" X 87"	1
SRP0478_	96" X 36" X 87"	2

Double Carpet Rack



SRP2473

2 welded Mini-Racking upright assemblies;
3 steel decking levels;

The 60" and 72" W proposals include medium-duty beams and the 96" W proposals include heavy-duty beams;

To order an add-on unit, complete product number with A;

To order bolted uprights, order SRPX5XX instead of SRPX4XX.

Product #	W x D x H	# of rails
SRP3475_	60" X 36" X 75"	2
SRP3476_	60" X 36" X 75"	4
SRP3473_	72" X 36" X 75"	2
SRP3474_	72" X 36" X 75"	4
SRP3477_	96" X 36" X 75"	2
SRP3478_	96" X 36" X 75"	4
SRP2475_	60" X 36" X 87"	2
SRP2476_	60" X 36" X 87"	4
SRP2473_	72" X 36" X 87"	2
SRP2474_	72" X 36" X 87"	4
SRP2477_	96" X 36" X 87"	2
SRP2478_	96" X 36" X 87"	4

High Density Floor Mat Rack



2 welded Mini-Racking upright assemblies;
4 steel decking levels;

Dividing rods;

To order an add-on unit, complete product number with A;

To order bolted uprights, order SRP0582 instead of SRP0482.

Product #	W x D x H
SRP0482_	60" X 36" X 87"

Battery Rack



SRP0461

2 welded Mini-Racking upright assemblies;
4 battery platforms;

87" H proposals also include one steel decking level;

To order an add-on unit, complete product number with A;

To order bolted uprights, order SRPX5XX instead of SRPX4XX.

Product #	W x D x H
SRP0460_	48" x 36" x 75"
SRP0461_	48" x 48" x 75"
SRP0462_	48" x 36" x 87"
SRP0463_	48" x 48" x 87"

Tire Rack



SRP0442

Single Row :

- 2 welded Mini-Racking upright assemblies;
- 3 pairs of beams for tire rack;
- 2 pairs of wall spacers;
- Floor anchor plates and hardware kit.

Double Row :

- 4 welded Mini-Racking upright assemblies;
- 6 pairs of beams for tire rack;
- 2 pairs of post spacers;
- Floor anchor plates and hardware kit;

To order an add-on unit, complete product number with A;

To order bolted uprights, order SRPX5XX instead of SRPX4XX.

Product #	W x D x H	Type
SRP0443	60" X 15" X 87"	Single
SRP0444	60" X 48" X 87"	Double
SRP0441	72" X 15" X 87"	Single
SRP0442	72" X 48" X 87"	Double

Bumper and Pipe Rack



SRP0420

- 2 welded Mini-Racking upright assemblies;
- 3 steel decking levels;

The 60" and 72" W proposals include medium-duty beams and the 96" W proposals include heavy-duty beams;

To order an add-on unit, complete product number with A;

To order bolted uprights, order SRPX5XX instead of SRPX4XX.

Product #	W x D x H	# of dividers
SRP1421	60" X 36" X 75"	4
SRP2421	60" X 48" X 75"	4
SRP1420	72" X 36" X 75"	4
SRP2420	72" X 48" X 75"	4
SRP1422	96" X 36" X 75"	6
SRP2422	96" X 48" X 75"	6
SRP0421	60" X 36" X 87"	4
SRP3421	60" X 48" X 87"	4
SRP0420	72" X 36" X 87"	4
SRP3420	72" X 48" X 87"	4
SRP0422	96" X 36" X 87"	6
SRP3422	96" X 48" X 87"	6

Windshield Rack



SRP0481

- 2 welded Mini-Racking upright assemblies;
- 3 steel decking levels;
- Proposals include heavy-duty beams;
- Dividing rods;

To order an add-on unit, complete product number with A;

To order bolted uprights, order SRPX5XX instead of SRPX4XX.

Product #	W x D x H	# of spaces
SRP0481	72" X 48" X 87"	8
SRP0480	96" X 48" X 87"	10

Sheet Metal Rack



SRP0430

- 2 welded Mini-Racking upright assemblies;
- 3 steel decking levels;

The 60" and 72" W proposals include medium-duty beams and the 96" W proposals include heavy-duty beams;

To order an add-on unit, complete product number with A;

To order bolted uprights, order SRPX5XX instead of SRPX4XX.

Product #	W x D x H	# of dividers
SRP1431	60" X 36" X 75"	2
SRP2431	60" X 48" X 75"	2
SRP1430	72" X 36" X 75"	2
SRP2430	72" X 48" X 75"	2
SRP1432	96" X 36" X 75"	3
SRP2432	96" X 48" X 75"	3
SRP0431	60" X 36" X 87"	2
SRP3431	60" X 48" X 87"	2
SRP0430	72" X 36" X 87"	2
SRP3430	72" X 48" X 87"	2
SRP0432	96" X 36" X 87"	3
SRP3432	96" X 48" X 87"	3



Proposals

AUTOMOTIVE

Bumper Cover Double Rack



WMA3510

1-85 1/2" H centered stand;
12 pairs of bumper supports.

Product #	W x D x H	
WMA3510	45" x 42" x 85 1/2"	Standard version
WMA3511	45" x 42" x 87"	With leveling glide kit
WMA3512	45" x 42" x 91"	With 4" casters : 2 rigid and 2 swivel with total-lock brake
WMA3513	45" x 42" x 91"	With 4" casters : 2 swivel and 2 swivel with total-lock brake

Wall-Mounted Bumper Cover Rack



6 pairs of bumper supports;
2 multi-purpose wall-mounted uprights. 300 lb capacity (wall and wall anchoring must be strong enough);
Wall anchoring not included.

Product #	W x D x H
WMP1000	42" X 23" X 72"

Moulding Rack



SRP0410

4 upright assemblies;
1 back sway brace;
Dividing rods;
To order an add-on unit, complete product number with A;
To order bolted uprights, order SRPX5XX instead of SRPX4XX.

Product #	W x D x H	# of Shelves	# of Spaces
SRP0413	36" x 48" x 75"	10	54
SRP0411	36" x 48" x 87"	12	66
SRP0412	48" x 48" x 75"	10	72
SRP0410	48" x 48" x 87"	12	88

Hood Rack



SRP0450

2 welded Mini-Racking upright assemblies;
Medium-duty beams;
2 steel decking levels;
Floor anchor plates and hardware kit;
To order an add-on unit, complete product number with A;
To order bolted uprights, order SRPX5XX instead of SRPX4XX.

Product #	W x D x H
SRP2450	48" X 48" X 75"
SRP2451	60" X 48" X 75"
SRP0450	48" X 48" X 87"
SRP0451	60" X 48" X 87"

 **Hood Rack must be anchored to the floor (anchoring kit included).**

Components

Double Divider for Mini-Racking

SR60

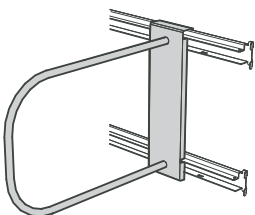

Supports parts and boxes that are stored vertically in a Mini-Racking unit. Parts lean against the "D" shape of the divider;
Attaches on 2 SR21 medium-duty beams or 2 SR22 heavy-duty beams;
Space between the two beams should be 14" c/c;
Divider can be adjusted laterally (left to right) without tools;
Locks in position when load is applied laterally;
Compatible with shelving 24" deep and deeper.

Product #	D x H
SR60-2415	24" x 15"

Single Divider for Mini-Racking

SR61

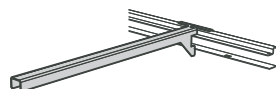

Divides those parts that lean vertically against the back of the Mini-Racking;
Installs on SR21 medium-duty beams or SR22 heavy-duty beams ;
Dividers can be adjusted laterally (left to right) without tools;
Locks in position when load is applied laterally;
Compatible with shelving 24" deep and deeper.

Product #	Depth
SR61-2401	24"

Hanging Rail – Single and Double

SR62

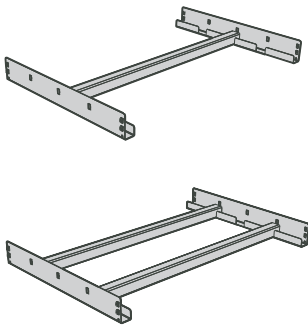

Single rail: SR62-XXXX01;
 Double rail: SR62-XXXX02;
 For storage of parts of non-standard sizes;
 300 lb capacity per rail;
 Rail adaptors :
 Install on the Spider® post with hooks, no bolts;
 Includes security mechanism to keep from accidentally unhooking;
 3 installation positions possible : one in the middle and two closer to the edges;
 Compatible with SR63-02 hooks (not included);
 Hooks pivot once installed on the rail. They can be put on and taken off the rail at all times, even when the rail is in place on the adaptors;
 Rail and adaptors in galvanized steel;
 When ordering, specify the last 2 digits in the number code. Ex. : SR62-6024Q2 for a double hanging rail that is 60" W x 24" D.

Product #	W x D
SR62-601801	60" x 18"
SR62-6024	60" x 24"
SR62-6036	60" x 36"
SR62-721801	72" x 18"
SR62-7224	72" x 24"
SR62-7236	72" x 36"
SR62-961801	96" x 18"
SR62-9624	96" x 24"
SR62-9636	96" x 36"

NOTE To order a unit of industrial shelving or Mini-Racking,

SEE PAGES 56-77

Hook for Hanging Rail

SR63



50 lb capacity per hook;
 Hooks pivot once installed on the SR62 rail;
 They can be put on and taken off even when the rail is in place on the adaptors.

Product #	Height
SR63-02	5"

Dividing Rods

SH56



Sold in pairs;
 Steel rods with 1/4" diameter;
 90° fold at one end to ensure it stays in place;
 Superior rigidity compared to plastic rods currently used on the market for this type of application.

Product #	Height
SH56-72	72"
SH56-84	84"
SH56-96	96"

Wall Spacers

SR45

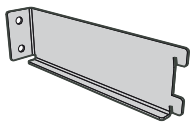

Sold in pairs;
 Spaces shelving 9" away from the wall;
 Attaches to the SR post in the delta holes without tools; must be secured in place with plastic clip (included);
 Galvanized steel.

Product #	Depth
SR45-09	9"

Post Spacers

SR48

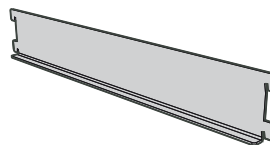

Sold in pairs;
 Spaces two back-to-back shelving units 18" apart;
 Attaches to the SR post in the delta holes without tools; must be secured in place with plastic clips (included);
 Galvanized steel.

Product #	Depth
SR48-18	18"

Beams for Tire Rack

SR20

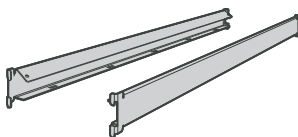

Sold in pairs;
 340 lb capacity per pair;
 Allows for storage of popular sized tires of different dimensions up to 17" in diameter (light truck and SUV);
 Constructed with a sloped surface to prevent the deformation of tires;
 72" wide beams require a tie bar SR25 installed in the center;
 15" deep units recommended for tires;
 12" deep units recommended for rims.

Product #	Width
SR20-36	36"
SR20-48	48"
SR20-60	60"
SR20-72	72"

Battery Platform

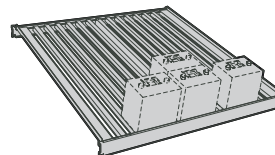

Level includes 2 heavy-duty beams and 13 tie bars;
 Equipped with a front stop and two side rails to prevent the batteries from falling;
 15° inclination eases the movement of batteries forward for easy access;
 Galvanized steel.

Product #	W x D	# of batteries (medium size)
SRP9001	48" x 36"	20
SRP9002	48" x 48"	28

NOTE To order a unit of industrial shelving or Mini-Racking,

SEE PAGES 56-77

Automotive Storage Rack

AUTOMOTIVE



SPECIALIZED AUTOMOTIVE STORAGE

For some years now, Rousseau has been developing a system that offers a complete and integrated storage solution for the automotive industry. Whatever your needs, we are able to provide a heavy-duty and aesthetically pleasing option for even the most discerning automotive dealer.

What we offer is more than a simple product. It is a complete system to help you organize your parts department. Included are bumper and pipe racks, sheet metal racks, battery and tire racks, etc.

The variety and flexibility of the Rousseau line represents a great advantage. It is a system that will grow with your needs. We are proud to be able to help answer the needs of any customer, big or small, and always offer the same quality and service which has become our trademark.

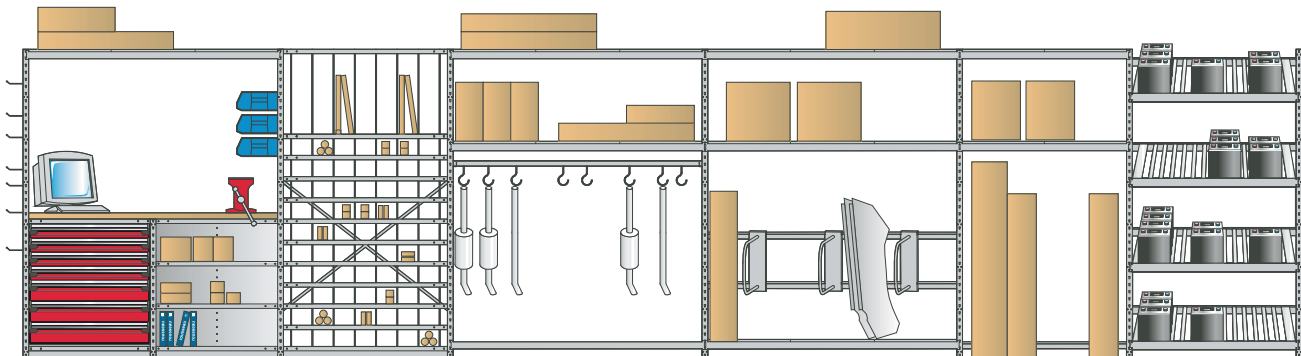

Automotive Storage Rack

AUTOMOTIVE

One Solution for Each Application

The strength of our system is that it adapts to your environment and evolves with your needs.

With the numerous dimensions and variety of accessories offered, you can create your own customized layout to complement the structure of your building.

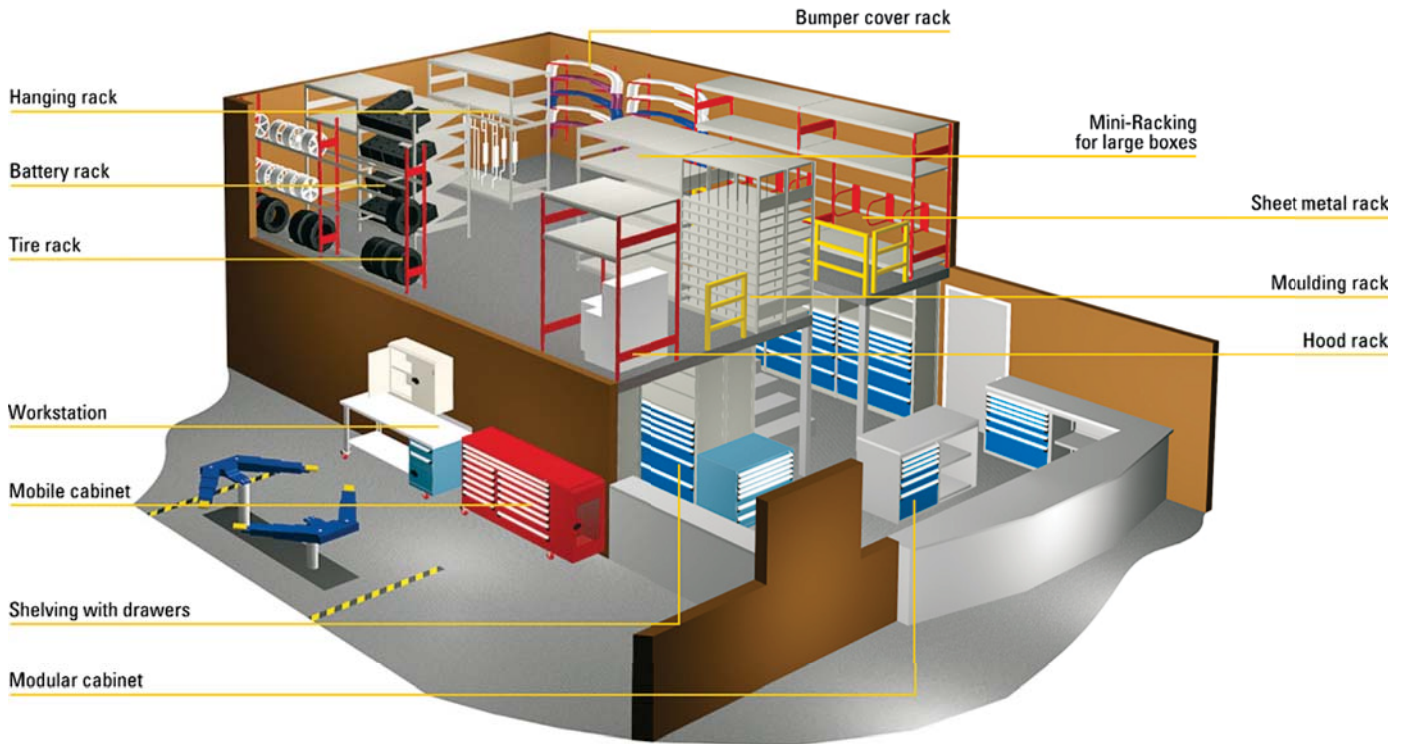

<i>Index</i>	<i>Page(s)</i>
<u>Automobile Storage Rack</u>	182- 183
<i>Proposals</i>	184- 186
<i>Components</i>	187

Some Accomplishments



Proposals

AUTOMOTIVE

Single Hanging Rack



SRP0404

2 welded Mini-Racking upright assemblies;
3 steel decking levels;

The 60" and 72" W proposals include medium-duty beams and the 96" W proposals include heavy-duty beams;

To order an add-on unit, complete product number with A;

To order bolted uprights, order SRPX5XX instead of SRPX4XX.

Product #	W x D x H	# of rails (hooks)
SRP1405_	60" x 36" x 75"	1 (15)
SRP1406_	60" x 36" x 75"	2 (30)
SRP1403_	72" x 36" x 75"	1 (15)
SRP1404_	72" x 36" x 75"	2 (30)
SRP1407_	96" x 36" x 75"	1 (25)
SRP1408_	96" x 36" x 75"	2 (45)
SRP0405_	60" x 36" x 87"	1 (15)
SRP0406_	60" x 36" x 87"	2 (30)
SRP0403_	72" x 36" x 87"	1 (15)
SRP0404_	72" x 36" x 87"	2 (30)
SRP0407_	96" x 36" x 87"	1 (25)
SRP0408_	96" x 36" x 87"	2 (45)

Double Hanging Rack



SRP2404

2 welded Mini-Racking upright assemblies;
3 steel decking levels;

The 60" and 72" W proposals include medium-duty beams and the 96" W proposals include heavy-duty beams;

To order an add-on unit, complete product number with A;

To order bolted uprights, order SRPX5XX instead of SRPX4XX.

Product #	W x D x H	# of rails (hooks)
SRP3405_	60" X 36" X 75"	2 (30)
SRP3406_	60" X 36" X 75"	4 (60)
SRP3403_	72" X 36" X 75"	2 (30)
SRP3404_	72" X 36" X 75"	4 (60)
SRP3407_	96" X 36" X 75"	2 (50)
SRP3408_	96" X 36" X 75"	4 (90)
SRP2405_	60" X 36" X 87"	2 (30)
SRP2406_	60" X 36" X 87"	4 (60)
SRP2403_	72" X 36" X 87"	2 (30)
SRP2404_	72" X 36" X 87"	4 (60)
SRP2407_	96" X 36" X 87"	2 (50)
SRP2408_	96" X 36" X 87"	4 (90)

Single Carpet Rack



SRP0473

2 welded Mini-Racking upright assemblies;
3 steel decking levels;

The 60" and 72" W proposals include medium-duty beams and the 96" W proposals include heavy-duty beams;

To order an add-on unit, complete product number with A;

To order bolted uprights, order SRPX5XX instead of SRPX4XX.

Product #	W x D x H	# of rails
SRP1475_	60" X 36" X 75"	1
SRP1476_	60" X 36" X 75"	2
SRP1473_	72" X 36" X 75"	1
SRP1474_	72" X 36" X 75"	2
SRP1477_	96" X 36" X 75"	1
SRP1478_	96" X 36" X 75"	2
SRP0475_	60" X 36" X 87"	1
SRP0476_	60" X 36" X 87"	2
SRP0473_	72" X 36" X 87"	1
SRP0474_	72" X 36" X 87"	2
SRP0477_	96" X 36" X 87"	1
SRP0478_	96" X 36" X 87"	2

Double Carpet Rack



SRP2473

2 welded Mini-Racking upright assemblies;
3 steel decking levels;

The 60" and 72" W proposals include medium-duty beams and the 96" W proposals include heavy-duty beams;

To order an add-on unit, complete product number with A;

To order bolted uprights, order SRPX5XX instead of SRPX4XX.

Product #	W x D x H	# of rails
SRP3475_	60" X 36" X 75"	2
SRP3476_	60" X 36" X 75"	4
SRP3473_	72" X 36" X 75"	2
SRP3474_	72" X 36" X 75"	4
SRP3477_	96" X 36" X 75"	2
SRP3478_	96" X 36" X 75"	4
SRP2475_	60" X 36" X 87"	2
SRP2476_	60" X 36" X 87"	4
SRP2473_	72" X 36" X 87"	2
SRP2474_	72" X 36" X 87"	4
SRP2477_	96" X 36" X 87"	2
SRP2478_	96" X 36" X 87"	4

High Density Floor Mat Rack



2 welded Mini-Racking upright assemblies;
4 steel decking levels;

Dividing rods;

To order an add-on unit, complete product number with A;

To order bolted uprights, order SRP0582 instead of SRP0482.

Product #	W x D x H
SRP0482_	60" X 36" X 87"

Battery Rack



SRP0461

2 welded Mini-Racking upright assemblies;
4 battery platforms;

87" H proposals also include one steel decking level;

To order an add-on unit, complete product number with A;

To order bolted uprights, order SRPX5XX instead of SRPX4XX.

Product #	W x D x H
SRP0460_	48" x 36" x 75"
SRP0461_	48" x 48" x 75"
SRP0462_	48" x 36" x 87"
SRP0463_	48" x 48" x 87"

Tire Rack



SRP0442

Single Row :

- 2 welded Mini-Racking upright assemblies;
- 3 pairs of beams for tire rack;
- 2 pairs of wall spacers;
- Floor anchor plates and hardware kit.

Double Row :

- 4 welded Mini-Racking upright assemblies;
- 6 pairs of beams for tire rack;
- 2 pairs of post spacers;
- Floor anchor plates and hardware kit;

To order an add-on unit, complete product number with A;

To order bolted uprights, order SRPX5XX instead of SRPX4XX.

Product #	W x D x H	Type
SRP0443	60" X 15" X 87"	Single
SRP0444	60" X 48" X 87"	Double
SRP0441	72" X 15" X 87"	Single
SRP0442	72" X 48" X 87"	Double

Bumper and Pipe Rack



SRP0420

- 2 welded Mini-Racking upright assemblies;
- 3 steel decking levels;

The 60" and 72" W proposals include medium-duty beams and the 96" W proposals include heavy-duty beams;

To order an add-on unit, complete product number with A;

To order bolted uprights, order SRPX5XX instead of SRPX4XX.

Product #	W x D x H	# of dividers
SRP1421	60" X 36" X 75"	4
SRP2421	60" X 48" X 75"	4
SRP1420	72" X 36" X 75"	4
SRP2420	72" X 48" X 75"	4
SRP1422	96" X 36" X 75"	6
SRP2422	96" X 48" X 75"	6
SRP0421	60" X 36" X 87"	4
SRP3421	60" X 48" X 87"	4
SRP0420	72" X 36" X 87"	4
SRP3420	72" X 48" X 87"	4
SRP0422	96" X 36" X 87"	6
SRP3422	96" X 48" X 87"	6

Windshield Rack



SRP0481

- 2 welded Mini-Racking upright assemblies;
- 3 steel decking levels;
- Proposals include heavy-duty beams;
- Dividing rods;

To order an add-on unit, complete product number with A;

To order bolted uprights, order SRPX5XX instead of SRPX4XX.

Product #	W x D x H	# of spaces
SRP0481	72" X 48" X 87"	8
SRP0480	96" X 48" X 87"	10

Sheet Metal Rack



SRP0430

- 2 welded Mini-Racking upright assemblies;
- 3 steel decking levels;

The 60" and 72" W proposals include medium-duty beams and the 96" W proposals include heavy-duty beams;

To order an add-on unit, complete product number with A;

To order bolted uprights, order SRPX5XX instead of SRPX4XX.

Product #	W x D x H	# of dividers
SRP1431	60" X 36" X 75"	2
SRP2431	60" X 48" X 75"	2
SRP1430	72" X 36" X 75"	2
SRP2430	72" X 48" X 75"	2
SRP1432	96" X 36" X 75"	3
SRP2432	96" X 48" X 75"	3
SRP0431	60" X 36" X 87"	2
SRP3431	60" X 48" X 87"	2
SRP0430	72" X 36" X 87"	2
SRP3430	72" X 48" X 87"	2
SRP0432	96" X 36" X 87"	3
SRP3432	96" X 48" X 87"	3



Proposals

AUTOMOTIVE

Bumper Cover Double Rack



WMA3510

1-85 1/2" H centered stand;
12 pairs of bumper supports.

Product #	W x D x H	
WMA3510	45" x 42" x 85 1/2"	Standard version
WMA3511	45" x 42" x 87"	With leveling glide kit
WMA3512	45" x 42" x 91"	With 4" casters : 2 rigid and 2 swivel with total-lock brake
WMA3513	45" x 42" x 91"	With 4" casters : 2 swivel and 2 swivel with total-lock brake

Wall-Mounted Bumper Cover Rack



6 pairs of bumper supports;
2 multi-purpose wall-mounted uprights. 300 lb capacity (wall and wall anchoring must be strong enough);
Wall anchoring not included.

Product #	W x D x H
WMP1000	42" X 23" X 72"

Moulding Rack



SRP0410

4 upright assemblies;
1 back sway brace;
Dividing rods;
To order an add-on unit, complete product number with A;
To order bolted uprights, order SRPX5XX instead of SRPX4XX.

Product #	W x D x H	# of Shelves	# of Spaces
SRP0413	36" x 48" x 75"	10	54
SRP0411	36" x 48" x 87"	12	66
SRP0412	48" x 48" x 75"	10	72
SRP0410	48" x 48" x 87"	12	88

Hood Rack



SRP0450

2 welded Mini-Racking upright assemblies;
Medium-duty beams;
2 steel decking levels;
Floor anchor plates and hardware kit;
To order an add-on unit, complete product number with A;
To order bolted uprights, order SRPX5XX instead of SRPX4XX.

Product #	W x D x H
SRP2450	48" X 48" X 75"
SRP2451	60" X 48" X 75"
SRP0450	48" X 48" X 87"
SRP0451	60" X 48" X 87"

 **Hood Rack must be anchored to the floor (anchoring kit included).**

Components

Double Divider for Mini-Racking

SR60

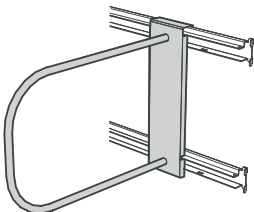

Supports parts and boxes that are stored vertically in a Mini-Racking unit. Parts lean against the "D" shape of the divider;
Attaches on 2 SR21 medium-duty beams or 2 SR22 heavy-duty beams;
Space between the two beams should be 14" c/c;
Divider can be adjusted laterally (left to right) without tools;
Locks in position when load is applied laterally;
Compatible with shelving 24" deep and deeper.

Product #	D x H
SR60-2415	24" x 15"

Single Divider for Mini-Racking

SR61

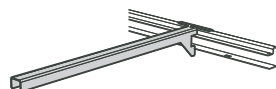

Divides those parts that lean vertically against the back of the Mini-Racking;
Installs on SR21 medium-duty beams or SR22 heavy-duty beams ;
Dividers can be adjusted laterally (left to right) without tools;
Locks in position when load is applied laterally;
Compatible with shelving 24" deep and deeper.

Product #	Depth
SR61-2401	24"

Hanging Rail – Single and Double

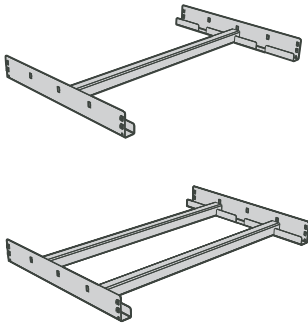

Single rail: SR62-XXXX01;
 Double rail: SR62-XXXX02;
 For storage of parts of non-standard sizes;
 300 lb capacity per rail;
 Rail adaptors :
 Install on the Spider® post with hooks, no bolts;
 Includes security mechanism to keep from accidentally unhooking;
 3 installation positions possible : one in the middle and two closer to the edges;
 Compatible with SR63-02 hooks (not included);
 Hooks pivot once installed on the rail. They can be put on and taken off the rail at all times, even when the rail is in place on the adaptors;
 Rail and adaptors in galvanized steel;
 When ordering, specify the last 2 digits in the number code. Ex. : SR62-6024Q2 for a double hanging rail that is 60" W x 24" D.

Product #	W x D
SR62-601801	60" x 18"
SR62-6024	60" x 24"
SR62-6036	60" x 36"
SR62-721801	72" x 18"
SR62-7224	72" x 24"
SR62-7236	72" x 36"
SR62-961801	96" x 18"
SR62-9624	96" x 24"
SR62-9636	96" x 36"

NOTE To order a unit of industrial shelving or Mini-Racking,

SEE PAGES 56-77

Hook for Hanging Rail

SR63



50 lb capacity per hook;
 Hooks pivot once installed on the SR62 rail;
 They can be put on and taken off even when the rail is in place on the adaptors.

Product #	Height
SR63-02	5"

Dividing Rods

SH56



Sold in pairs;
 Steel rods with 1/4" diameter;
 90° fold at one end to ensure it stays in place;
 Superior rigidity compared to plastic rods currently used on the market for this type of application.

Product #	Height
SH56-72	72"
SH56-84	84"
SH56-96	96"

Wall Spacers

SR45

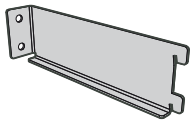

Sold in pairs;
 Spaces shelving 9" away from the wall;
 Attaches to the SR post in the delta holes without tools; must be secured in place with plastic clip (included);
 Galvanized steel.

Product #	Depth
SR45-09	9"

Post Spacers

SR48

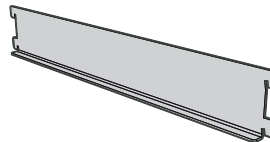

Sold in pairs;
 Spaces two back-to-back shelving units 18" apart;
 Attaches to the SR post in the delta holes without tools; must be secured in place with plastic clips (included);
 Galvanized steel.

Product #	Depth
SR48-18	18"

Beams for Tire Rack

SR20

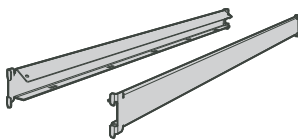

Sold in pairs;
 340 lb capacity per pair;
 Allows for storage of popular sized tires of different dimensions up to 17" in diameter (light truck and SUV);
 Constructed with a sloped surface to prevent the deformation of tires;
 72" wide beams require a tie bar SR25 installed in the center;
 15" deep units recommended for tires;
 12" deep units recommended for rims.

Product #	Width
SR20-36	36"
SR20-48	48"
SR20-60	60"
SR20-72	72"

Battery Platform

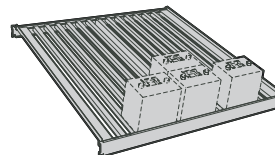

Level includes 2 heavy-duty beams and 13 tie bars;
 Equipped with a front stop and two side rails to prevent the batteries from falling;
 15° inclination eases the movement of batteries forward for easy access;
 Galvanized steel.

Product #	W x D	# of batteries (medium size)
SRP9001	48" x 36"	20
SRP9002	48" x 48"	28

NOTE To order a unit of industrial shelving or Mini-Racking,

SEE PAGES 56-77

Key Types

In order to ensure the security of work tools, it is important for them to be locked as required. Rousseau offers you a choice in the management of your keys. For example, if you have independent units that require different keys, or if you require different access depending on the user, we have three key types to choose from. There is the "identical key" (KA), the "different key" (KD), and the master key system (MK).

KEY TYPES

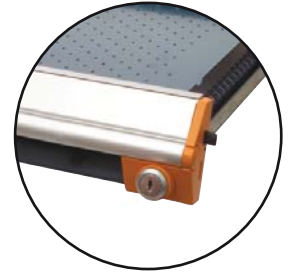
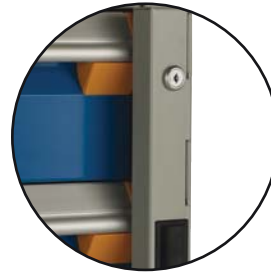

Specify the type of key desired : KA, KD, or MK.

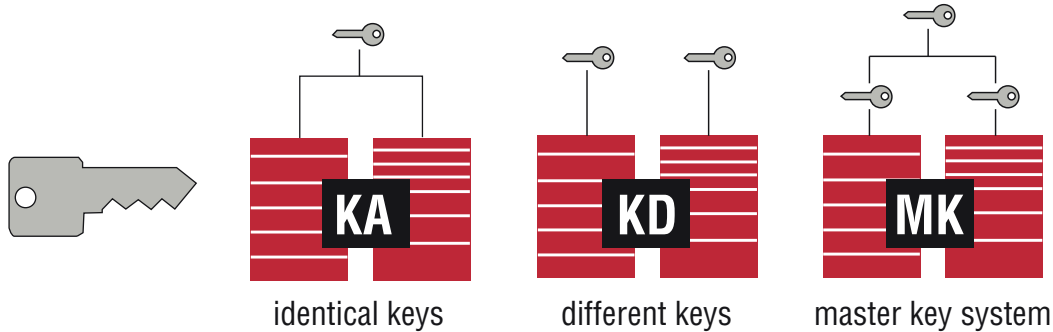

Products below need a key code when a lock is required :

Proposals :

- Heavy-Duty Modular Cabinet (R5A)
- Heavy-Duty Mobile Cabinet (R5B)
- Stacking Cabinet (R5H)
- Sink Cabinet (R5T)
- "L" Compact Cabinet (L3A)
- Smart-Compact Mobile Cabinet (L3B)
- Hanging Side Cabinet (R5Q)
- Multi-Drawer Cabinet (R5E)
- Mobile Multi-Drawer Cabinet (R5G)
- Drawers Unit (LD75)
- Wall-Mounted Computer Cabinet and Housing (R5M)
- Computer Cabinet (R5J)

Components and Accessories :

- Integrated Sliding Door or with Frame, Solid or Glass (RB50 / RB51 / RB55 / RB56 / WS60 / WS61)
- Single Integrated Door or with Frame, Solid or Glass (RB30 / RB31 / RD10 / RD11 / RD50)
- Double Integrated Door or with Frame, Solid or Glass (RB35 / RB36 / RB45 / RB46 / RD15 / RD16 / SH40 / SH42)
- Door for L Cabinet (LB30)
- Flipper Door (RD20 / SH85)
- Vertical Security Bar (RB10 / RE80)
- Compact Drawer (LF31)
- Central Locking System (L3)
- Heavy-Duty Drawer or roll-out shelf (RF31 / RF32 / RF40 / RF41 / RF44 / RF45)
- Heavy-Duty Cabinet and Stacking Cabinet Housing (RA30)
- Storage Cabinet (WM75)
- Slope Top (RC30)
- "L" Compact cabinet (LA30)

NOTE Please contact your customer service representative for questions regarding the different key types. They will be happy to advise you.

NOTE All items with a lock need to have a key code, the list above is only a reference.

Foam Insert Cutting Service

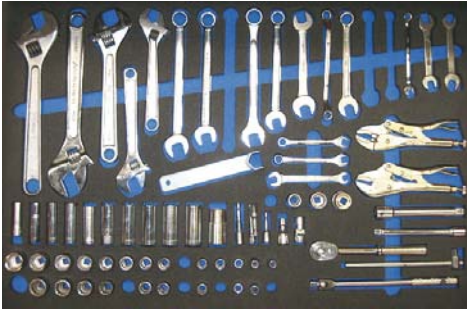

A drawing produced according to the criteria specified in technical document R58 must be submitted to Rousseau or have been previously produced by Rousseau. Here are the steps to follow:

- 1. If you are providing the drawing:**
 - a. Follow the same steps as presented below for the drawing service, but produce the drawing on your own. Please refer to technical document R58.
 - b. Forward your photo as well as your drawing to your customer service representative so that it may be validated before the foam is cut.
 - c. Rousseau will cut the foam inserts.
- 2. If the drawing is produced by Rousseau**
(following customer approval as explained in point #8):
 - a. Rousseau will cut the foam inserts.

Contact our customer service representative for pricing.

NOTE In order to respect the criteria and method for photo-taking, please be sure to consult technical document R58.

Drawing Service for Cutting Foam Inserts

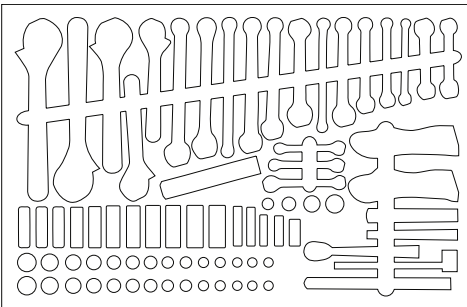

A photo respecting the specific criteria as outlined in the R58 technical document must be submitted to Rousseau. Here are the steps that must be followed for you to take the proper photo:

- 1. Identify the nominal dimensions of the drawer**
Example: RF31-**3027**04 = 30" x 27".
- 2. Determine the dimensions required for the foam insert**
According to the chart published on the R58 technical document.
Example: RG__-**3027**-02 = 25 1/2" x 23 1/2".
- 3. Cut a piece of cardboard to the same dimensions you require for the foam.**
- 4. Place the tools on the cardboard.**
To make sure that the minimum space requirements is respected between tools, see R58 technical document.
- 5. Take the photo with the tools in place**
For tools 1" in height, it is preferable to draw the outline of the tool as precisely as possible and to take the photo of the cardboard without the tool.
- 6. Forward the photo to your customer service representative** so that it can be validated before the drawing is produced.
- 7. A CAD designer will create a technical drawing** according to the photo that you have taken.
- 8. Approve the drawing.**
The drawing will be sent via e-mail by your customer service representative.

Contact our customer service representative for pricing.

NOTE In order to respect the criteria and method for photo-taking, please be sure to consult technical document R58.

Adaptors

Adaptors for LED Light	124
Adaptors for Leveling Glides	29, 103
Adaptors for WM Frame	122
Adaptor for WS50 Shelf	104
Caster Adaptors / Leg Extensions	98, 105
CNC Adaptor for H-D Drawer	177
CNC Adaptor for Shelving	177
CNC Adaptor for WM	177
Light-Duty Arm Adaptor	117
Shelf Adaptor for Common Leg	99
Vertical Adaptor for Electrical and Air Outlets	120

Arms

Document Holder with Arm	117
Light-Duty Arm	117

Bases

Angled Cover Plate	19, 107
Base for Casters for Compact Cabinet	105
Base Riser for Computer Cabinet	162
Base Riser for Mobile Cabinet	162
Compact Cabinet Base	29, 103
Cover Plate for Computer Cabinet	162
Extended Base for Casters	41
Forklift Base for H-D Cabinet	19, 107
Leveling Glide Kit	19, 107
Recessed Base for H-D Cabinet	19, 107, 162
Shelf Front or Front Base	70
Straight Cover Plate	19, 107, 162

Beams and Tie Bars

Beams for Tire Rack	187
Heavy-Duty Beams	76
Heavy-Duty Tie Bar	76
Medium-Duty Beams	76, 169
Medium-Duty Tie Bar	76, 169

Brackets

RE30 Mounting Brackets for Spider ® Shelving	67
RA73 Side Brackets for Top	106
RE00 Standard Mounting Brackets	83

Braces

Back Sway Brace	69, 168
Braces for Double Mobile Cabinet	39
Mini-Racking Ladder Braces	75, 168
Side Panel Braces	69, 168

Cabinets

Computer Cabinet	158-159
Hanging Side Cabinet- Front Access	37, 55
Hanging Side Cabinet- Side Access	37, 55
H-D Mobile Cabinet	32-35
H-D Modular Cabinet	6-9, 101
Compact Cabinet	22-23, 101
Smart Compact Mobile Cabinet	44-45
Multi-Drawer Mobile Cabinet	51-52
Multi-Drawer Stationary Cabinet	53-54
Sink Cabinet	14, 109
Smart Computer Cabinet	124, 161
Stacking Cabinet	14
Storage Cabinet	122, 124
Waste & Recycling Cabinet	15

Carts

Cart for Smart Compact Mobile Cabinet	49, 105
Mobile Cart for CNC Tool Storage	174

Casters

4" Casters	41, 49, 105, 107, 129, 163
6" Casters	41, 49, 105, 107, 129, 163
Extended Base for Casters	41

CNC Tool Storage Solutions

CNC Tool Storage Solutions	174-175
Tool Racks	176

Crossbars

Crossbar for Double Integrated Doors with Drawer Above	16, 42, 109
Crossbars for Wall Leg	98
Heavy-Duty Tie Bar for Mini-Racking	76
Medium-Duty Tie Bar for Mini-Racking	76
Table Leg Crossbar	98
Upright Cross Member for Multi-Purpose Upright	113
Wood Crossbar for Steel Top	97
Work Surface Steel Top Crossbar	97

Computer Stations

Computer Station	158-159
Computer Workstation	159-160
Multi-Purpose Stand	160
Smart Computer Cabinet	124, 161

Decking

PVC Decking for CNC Tools	181
Steel Decking	77, 180
Wire Decking	77

Dividers

Dividing Rods for SH Shelf	63, 186
Double Divider for Mini-Racking	74, 186
Drawer Divider for Compact Drawer	27, 47, 104
Drawer Divider for H-D Drawer	152
Partial Divider	10, 14, 63, 106, 114
Shelf Divider	63
Single Divider for Mini-Racking	74, 186
Sliding Divider for WS Shelf	115

Doors

Crossbar for Double Integrated Doors	16, 42, 109
Double Doors with Frame for H-D Cabinet	21
Double Integrated Doors for H-D Cabinet	16, 42, 109
Double Integrated Doors for Wall Cabinet	122
Flipper Door for Shelving	64
Flipper Door for Wall Cabinet	122
Glass Door for Computer Cabinet	164
Glass Door for Shelving	65
Integrated Sliding Doors for H-D Cabinet	21
Compact Cabinet Door	28, 48, 103
H-D Cabinet Door	16, 42, 109, 164
Single Integrated Door for Wall Cabinet	122
Sliding Doors for Workstation	100
Sliding Doors with Frame for H-D Cabinet	21
Solid Door for Shelving	65

Drawers

Bank of Drawers for Shelving	80-81
Drawer Unit for Workstation	29, 102
H-D Drawer for CNC Tools	178
H-D Drawer in Shelving	67, 82, 134-135
H-D Drawer for Cabinet	20, 40, 108, 134-135
H-D Drawers with Compartments	137-150
Keyboard Drawer	163
Compact Drawer	28, 48, 103
Compact Drawer for Hanging Folders	28, 48, 103
Waste & Recycling Cabinet	15, 155

Drawer Accessories

CNC Adaptors	177
Drawer Divider	27, 47, 152
Foam for Collets	153, 178
Foam for Protection	26, 46, 153, 178
Foam for Tools	153, 178
Front to Back Partition	26, 46, 151
Groove Trays	26, 46, 152, 178
Handle Protector	26, 40, 46, 108, 153
Hanging File Bars Compact Cabinets	26, 46, 104
Hanging File Bars Heavy-Duty Cabinets	155
Keyboard Riser	163
Left to Right Partition	151
Plastic Bins	26, 47, 66, 116, 154, 178
PVC Drawer Liner	26, 46, 153

ESD Protection

Conductive Plastic Bins	13, 112, 154
Dissipative Top	13, 96
ESD Cabinet	13
Grounding Wrist Strap	13, 112

Ergonomic Seats

.....	131
-------	-----

Extensions

Leg Extensions	98
Side Extension for Common Leg	99
Stringer Extension for Common Leg	99

Filler

Filler for Shelf	67, 84
Rail Filler	116

Foams

Foam for Collets for H-D Drawer	153, 178
Foam for Protection for H-D Drawer	153, 178
Foam for Tools for H-D Drawer	153, 178
Foam for Tools for Compact Drawer	26, 46, 104
PVC Drawer Liner for H-D Drawer	153-178
PVC Drawer Liner for Compact Drawer	26, 46, 104

Footrests

Adjustable Footrest	99
Ergonomic Footrest	99

Gussets

Adaptor for WS50 Shelf	106
Cabinet Attachment Bars	106
Corner Gussets for Industrial Shelving	69
Corner Gussets for Leg	99
Side Brackets for Top	106

Handles

Front Handles for Compact and H-D Cabinets	41, 45
Handle Protector for H-D Drawer	40, 108, 153
Replacement Handle for Multi-Purpose Stand	129
Side Handle for H-D Mobile Cabinet	41
Side Handle for Smart Compact Mobile Cabinet	49

Hanging File Bars

Compact Drawer	26, 46, 104
H-D Drawer	155

Hooks

Double Back Single and Double Hooks for Perforated Panel	66, 119
Hooks for Mini-Racking Rail	74, 187
Single Loop Hooks for Perforated Panel	66, 119
Straight Arm Hooks for Perforated Panel	66, 119

Housings

Computer Cabinet Housing with Back Panel	162
Drawer Housing Unit	29, 102
H-D Cabinet Housing	18, 39, 106
Compact Cabinet Housing	28, 48, 102
Stacking Cabinet Housing	15
Storage Cabinet for WM Unit Frame	121
Wall Cabinet Housing	122

Holders

Document Holder	129
Document Holder with Arm	117
LCD Monitor and Keyboard Holder	117, 118, 165
LCD Monitor Holder	117, 118, 165

Installation Accessories for Industrial Shelving

Floor Anchor Plate	66, 165
Floor Anchoring Hardware	66, 165
Shim Plate	66, 165
Wall Spacer	66, 165

Legs

Closed Leg	98
Leg Extensions	98
Open Leg	98
Open Wall-Mounted Leg	98

Locking and Security Mechanisms

Econo Lock-In Mechanism for H-D Drawer	24, 40, 68, 108, 155
H-D Drawer lock	24, 40, 68, 108, 153
H-D Cabinet Lock	10, 36
Integrated Lock-In Mechanism for H-D Drawer	20, 40, 68, 108, 155
Compact Door Lock	26, 46, 104
Compact Drawer Lock	26, 46, 104
Lock-Out Mechanism for H-D Drawer	24, 40, 68, 82, 108, 155
Security Panel for H-D Drawer	10, 36, 68, 82
True One-Drawer-at-a-Time System for H-D Cabinet	10, 36
Vertical Security Bar for H-D Drawer	10, 36
Vertical Security Bar for H-D Drawer in Shelving	68, 84

Lamps

Lamp with Double Fluorescent Light.....	121
Lamp with Magnifier and Fluorescent Light	121
LED Light	124
Lighting Fixture for Riser Shelf.....	111
Lighting Fixture for Wall Cabinet.....	122
Overhead Workstation Light.....	121
Parabolic Louver.....	121
Storage Cabinet Lighting Fixture	124

Label Holders

Handle Label for Compact Drawer	26, 46, 104
Label Holder for Divider.....	152
Label Holder for Mini-Racking	74, 180
Label Holder with Adhesive Strip for Plastic Bin	152
Magnetic Label Holder for SH Shelf.....	63
Paper Strip.....	152, 154
Self-Adhesive Label Holder for SH Shelf.....	63

Power Outlets	112, 120
----------------------------	----------

Panels

Back or Side Louvered Panel for Shelving.....	64
Back Panel for Riser Shelf	111
Back Panel for Shelving	70
Back Panel for Workstation	100
Finishing Panel for Shelving	64
Louvered Panel for WM Unit Frame.....	120
Panel Bracket Kit for WM Unit Frame.....	119, 120
Perforated Panel for Shelving	64, 70
Perforated Panel for WM Unit Frame.....	119
Privacy Panel for WM Unit Frame.....	119
Side Panel for Shelving	70
Side Panel for Workstation	100
Tackboard and Market Panel for WM Unit Frame	120
Wall Mounted Perforated Panel.....	114

Plastic Bins

Conductive Plastic Bin for H-D Drawer and Louvered Panel.....	112, 154
Plastic Bin for H-D Drawer and Louvered Panel.....	66, 116, 154, 178
Plastic Bin for Compact Drawer.....	27, 47

Posts

Mini-Racking Post.....	75, 168
Shelving Post.....	67, 168

Reinforcers

Center Shelf Reinforcer for Box Shelf	71
Front Shelf Reinforcer for Box Shelf	71
Side Shelf Reinforcers for Box Shelf	71
Top Reinforcer for Work Surface.....	113

Rails

Clothes Hanging Rail	65
Joiner for Tool Rail	116
Plastic Bin Rail for Industrial Shelving	66
Plastic Bin Rail for WM Unit Frame	115
Rail Filler	115
Single and Double Hanging Rails for Mini-Racking.....	74, 186
Tool Rail.....	116

Risers

Base Riser for Computer Cabinet.....	162
Base Riser for Mobile Cabinet.....	162
Keyboard Riser.....	163
Riser Shelf Supports	110

Shelves

Adjustable Shelf for H-D Cabinet	15, 41, 106, 163
Adjustable Shelf for Wall Cabinet	122
Bottom Shelf for H-D Cabinet	15, 41, 106, 163
Bottom Shelf for WM Unit Frame	129
Box Shelf for Industrial Shelving	71, 168, 179
Cabinet Shelf for Compact Cabinet.....	29, 48, 100
Dissipative Shelf for Riser Shelf Supports.....	110
Foldaway Shelf.....	38, 55, 164
H-D 3 Sided Access Roll-Out Shelf	24, 38, 65, 108, 134-135
H-D Bottom Shelf for Cabinet	163
H-D Front Access Roll-Out Shelf	24, 40, 67, 108, 134-135
Laminated Wood Shelf for Riser Shelf Supports.....	110
Plastic Laminated Shelf for Riser Shelf Supports	110
Resistant shelf for riser shelf support.....	110, 115
Roll-Out Shelf for Integrated Door.....	163
Shelf for Workstation	97, 115
Shelf for WM Upright.....	129
Side and Back Stops for Foldaway Shelf.....	38, 55, 164
Stainless steel shelf for riser shelf support.....	110, 115
Steel Shelf for Riser Shelf Supports.....	110
Tiltable Shelf for WM Unit Frame.....	115

Shelving

Back-to-Back Closed Shelving.....	59
Back-to-Back Open Shelving.....	59
Closed Shelving	58
Installation Accessories for Industrial Shelving.....	70, 169
Open Shelving	58
Shelving for Record Storage.....	167
Shelving with Accessories	60
Shelving with H-D Drawers.....	61-62, 80-81
Multi-Level Shelving.....	170-171

Mini-Racking

Record Storage.....	167
Without Decking.....	72-73, 167, 180
With Steel Decking	72-73, 167, 180
With Wire Decking	72-73

Supports

Automotive Storage Racks.....	184-185
Cantilever Overhead Supports for WM Unit Frame	113
Double Shelf Supports for Industrial Shelving	71
Econo Riser Shelf Supports.....	110
Paper and Cardboard Spool Support for WM Unit Frame.....	116
Paper and Cardboard Spool Support for Workstation	100
Riser Shelf Supports	108
Spool Support for Industrial Shelving.....	64
Structural Shelf Supports for Workstation.....	113
Tool Support for Workstation	113
Wire Spool Support for Workstation	113
Wood Top Support for Mini-Racking.....	72, 95

Spacers

Back-to-Back Spacers for Mini-Racking.....	74, 168
Post Spacers for Mini-Racking.....	187
Wall Spacer for Industrial Shelving.....	70
Wall Spacers for Mini-Racking.....	187

Stands

Multi-Purpose Stands.....	127-128
---------------------------	---------

Stops

Back and Side Stops for Top.....	11, 38, 97
Shelf Back or Front Stop.....	111
Side and Back Stops for Foldaway Shelf.....	38, 47, 55, 164

Tops

Dissipative Top for Workstation.....	96
Galvanized Steel Top for H-D Cabinet.....	11, 38
Laminated Wood Top for H-D Cabinet.....	11, 38
Laminated Wood Top for Compact Cabinet.....	27, 47
Laminated Wood Top for Shelving.....	74, 97
Laminated Wood Top for Workstation.....	96
Painted Steel Top for H-D Cabinet.....	11, 38
Painted Steel Top for Workstation.....	96
Resistant Acrylic/PVC Plastic Laminated Top.....	96
Plastic Laminated Top for Compact Cabinet.....	27, 47
Plastic Laminated Top for Workstation.....	96
Slope Top for H-D Cabinet.....	10
Stainless Steel Top for H-D Cabinet.....	11, 38
Stainless Steel Top for Workstation.....	96
Steel Top Crossbar.....	97
Steel Top with Rubber Mat for H-D Cabinet.....	11, 38
Steel Top with Rubber Mat for Compact Cabinet.....	27, 47
Wood Composite Top for Workstation.....	96
Wood Crossbar for Steel Top.....	97
Wood Filler for Steel Top.....	97

Trays

Groove Tray for H-D Drawer.....	153, 178
Keyboard and Mouse Tray.....	117, 118, 165
Standard Monitor Tray.....	117, 118, 165

Uprights

Multi-Purpose Upright.....	113
Multi-Purpose Wall Mounted Frame.....	114
Top Flange for WM10 Upright.....	113
Upright Cross Member.....	113

Work Centers















Basic Workbenches.....	88-91
Multi-Purpose Stands.....	127-128
Specialized Workbenches.....	92-95
Specialized Work Centers.....	125
Table with Multi-Purpose Frames.....	93-95

Committed to Sustainable Development, Rousseau Metal Inc. is pleased to use FSC Paper, sourced from well Managed Forests.

COLORS

Standard Colors

The colors may differ slightly from those illustrated.

													
Avalanche Blue 055	Everest Blue 051	Classic Blue 052	Midnight Blue 057	Boreal Green 102	Black 091	Beige 041	Frost White 061	Light Gray 071	Charcoal Gray 072	Yellow* 208	Sienna Orange 085	Flame Red 081	White 616

Note: For custom colors, contact our customer service representatives.
*Certain restrictions do apply, contact our customer service representatives.

Handle End Caps and Door Handle



Ocean Blue
011

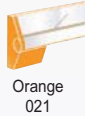

Orange
021

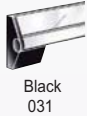

Black
031



SOUTHWEST **SOLUTIONS** GROUP
business organization systems