



SOUTHWEST**SOLUTIONS**GROUP

business organization systems

**Mail Center
Commercial Pricing Guide**

Effective September 1, 2014

Masterseries
Executive Series

Masterseries and Executive Series

Designed to meet your project specifications

Hamilton Sorter's **Masterseries** and Executive Series manufactured products give designers and end-users a modular, flexible and durable alternative to built-in millwork. Made from laminate and aluminum extrusions it provides the flexibility and strength needed for rigorous applications in document processing.

Hamilton Sorter products are designed to meet the rigorous conditions of today's work environment.

For over 46 years, Hamilton Sorter products have been designed and manufactured to provide the very finest in modular, flexible and durable solutions for the commercial workplace.

All backed by Hamilton Sorter's Limited **Lifetime Warranty**.

Construction

- ◆ Product is constructed of industrial grade 40-50 lb. substrate and aluminum extrusions.
- ◆ Ideal for high traffic areas, aluminum frame consoles withstand in excess of 1,000 lbs. Aluminum frames eliminate exposed edges and protect laminate work surfaces.
- ◆ A Hamilton Sorter exclusive, the pin cam locking system safely secures sort module at any position on the console. The system easily readjusts toward the front or back to accommodate the reach of varying personnel.
- ◆ All module and riser edges are sealed with impact-resistant PVC for durability; there are no exposed edges on our casegoods.
- ◆ Wheels are standard options for Hamilton Sorter's Masterseries and are available on all aluminum framed consoles.

Table of Contents

MASTERseries

TERMS AND DEFINITIONS	4
SORT MODULES	5
How to Specify Product Line	
CORNER CONSOLES AND MODULES GUIDELINES	24
FREESTANDING SORT MODULES	25
How to Specify Product Line	
MODULE ACCESSORIES	28
Product Line Notes	
BULK SORT	30
Product Line	
CONSOLES	31
How to Specify Product Line	
SPECIALTY CONSOLES	40
How to Specify Product Line	
INTERMEDIATE SHELF	42
How to Specify Product Line	
SELECTING CONSOLE ACCESSORIES	46
How to Specify Product Line	
PLATFORM	49
How to Specify Product Line	

Executive Series

CONSOLES	52
How to Specify Product Line	
MAIL STATIONS	57
How to Specify Product Line	
LAMINATES	60
LEED CREDIT CALCULATION	61
HAMILTON SORTER'S LIFETIME GUARANTEE	BACK COVER

Terms and Definitions

The following glossary defines some of the basic components used in designing a MailCenter. Detailed dimensions and model numbers are indicated in the various sections of this price book.

MASTERseries



SORT MODULES One to six-sections wide, 18" to 48" high, with or without built-in risers. Support sorting shelves in 1" vertical increments. Sort Modules lock to the aluminum console frame and are available with closed back on the Hamilton Sorter Priority Program. Available with open backs and optional plexi-glass display boards and doors on standard lead-time.



re-inserted. Are available in half and full-depths in sizes to fit all standard-size consoles.

PLATFORMS Provide additional worksurface and clearance for machines. Lock into aluminum console frame for security. Available with optional aluminum extrusion for additional support and keyboard mounting.



FREESTANDING SORT MODULES A stand-alone version of our sort modules. Three and four sections wide, 48" to 76" high. Available in full height or with optional bottom storage space on the Hamilton Sorter Priority Program. Available with optional doors and sliding reference shelf on standard lead-time.



SORTING SHELVES Available in three basic sizes, shelves come with full-width label channels with clear plastic covers. Shelves are available in clear, black, brown, & grey. Plastic shelves support up to 35 lbs., optional laminate shelves support up to 50 lbs., available on standard lead-time.

Standard: 10³/₄" x 11³/₄" for letter-size documents, literature and forms.

Legal: 10³/₄" x 15³/₄" for legal documents and spreadsheets.

Over-size: 12³/₄" x 15³/₄" for full-size overnight envelopes, computer printouts and newspapers.

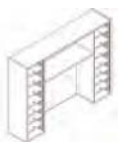

READER STATION Reader Stations are sort modules with an opening to accommodate a computer monitor. Opening and binder shelf can be positioned left, right or center.



BULK SORT UNITS Units provide higher shelf clearances for sorting of larger packages. Available in desktop and freestanding units, with flat or angled shelves. Will accommodate a variety of tubs for bulk sorting large quantities of mail.



CONSOLES Used alone or to support sort modules. Available with optional half and full-depth shelves and sliding doors. Widths range from 24" to 84", depths between 24" and 36" and heights of 30" and 36". Ergonomically designed with clear, anodized-aluminum frame.



DUMP RIMS Securely lock to the aluminum console frame to contain mail dumped on the worksurface for sorting. Can be used on individual or ganged consoles.



INTERMEDIATE SHELVES Can be placed inside consoles with full-depth shelves or sliding doors for additional storage space. Can easily be removed and

Executive Series



CONSOLES Executive Consoles are light-use tables with no aluminum extrusions and are not intended for general mail center use. Available in a basic style, with a full shelf and a full shelf with doors. Consoles with half legs and corner Consoles can be combined to form a larger desking unit.



COUNTER CONSOLES Counter Consoles feature a standard console combined with a 16" wide counter surface. Often used in reception areas, Counter Consoles are available in widths ranging from 48" to 72".



CREDENZAS Credenzas feature hinged doors, handles, a recessed 3" kickplate, and interior adjustable shelving. They are also available with or without predrilled mail slots. (See Executive Mail Station for Credenza with slots.)



OVERHEAD UNITS Storing items overhead can dramatically increase available worksurface. Overhead units are available with hinged or retractable doors or even no doors at all. Optional accessories include fabric-covered tackboards and undersurface task lights.



STORAGE UNITS Lateral files are available in two, three, and four drawer units while pedestals offer two and three drawer configurations. Pedestals are available in two heights, one of which permits undertable placement. Lateral files and pedestals all feature gang locks and anti-tip mechanisms.



BOOKCASES Executive Series Bookcases feature extra-deep adjustable shelves to facilitate binder storage. Two widths and five heights combine to accommodate a variety of storage needs.



EXECUTIVE MAIL STATIONS Provide a central location for mail-drop off and collection on each floor or within each department. Not intended for heavy mail-room use. Executive console doors feature optional mail slots for outgoing mail drop-off. Laminated trim offers an executive look for front office environments.

Sort Modules

How to Specify Your Options

Riser Option	Pass Through
Closed	Po3 = 3" Open
Eo3 = 3" Riser	Po6 = 6" Open
Eo6 = 6" Riser	P12 = 12" Open
E12 = 12" Riser	P18 = 18" Open
E18 = 18" Riser	Leave blank if no riser desired.

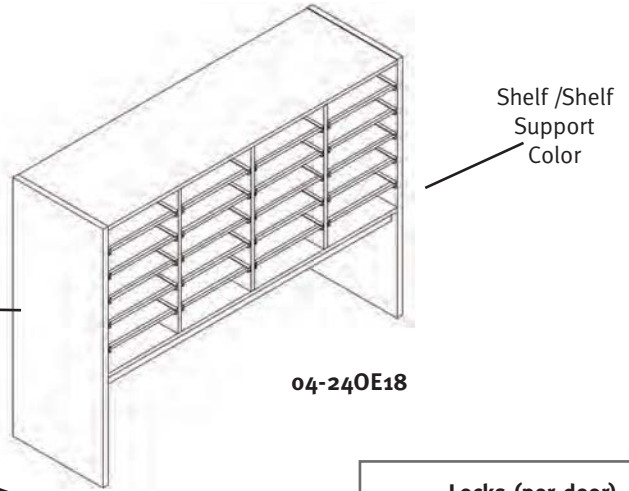

Slot Type

S = Standard Size
L = Legal Size
O = Oversize

Sorting Height

Riser Option

Plexiglass Doors

F = Front
R = Rear
B = Both

Locks (per door)

Model#	Increase	Description
T	\$0	Thumb Latch
K	\$30	Key Locks

0 3 - 3 6 P E o 6 x F C T

Number of Columns

Back
C = Closed
O = Open
P = Plexiglass

Plexiglass Color

Display Board
x = No Board
Y = Board

Plexiglass Color

Model#	Increase	Description
x	\$0	No
C	\$0	Clear
S	\$16	Smoke

See page 60 for color codes.

See Page 23 for Pricing

Notes

- To calculate the sorting inches per column, take the total height of the unit, subtract any riser, subtract 2" for the top and bottom of the unit. Example: S5-30E6; 36 (total height) - 6 (riser) - 2 (top & bottom) = 28 sorting inches per column X 5 columns = 140 total sorting inches.
- Shelf supports are adjustable on 1" increments.
- Modules with sorting heights of 18", 24" and 30" include five shelves per column, providing a total of six mail slots per column. Modules with sorting heights of 36", 42" and 48" include seven shelves per column, providing a total of eight mail slots per column. Example: An S5-30 has five shelves for each of the five columns for a total of 25 shelves. Six slots for each of the five columns equal a total of 30 mail slots.
- If a module has a riser, use the sorting height only to calculate the number of shelves included. Example: S5-30E6 has a total height of 36" but a sorting height of only 30". Five shelves are included with this module.
- Additional shelves may be ordered if more slots are required. Shelves may also be deleted if fewer slots are required.
- Inside Column Dimensions (between shelf supports)

Size	Inside Width	Inside Depth
Standard	10 ¹ / ₈ "	12"
Legal	10 ¹ / ₈ "	16"
Oversize	12 ¹ / ₈ "	16"

- Modules with 6" risers that are 54" or more in width have a center riser leg. All modules with 12" or 18" risers feature a 2" front fascia on the riser. (Clearance = riser height - 2"). All modules with 12" or 18" open risers have a 2" fascia on the riser front and back. Open-back modules with no riser have a 2" fascia across the upper rear. Open-back modules must have closed-back risers and modules with open-back risers must be closed back. These features help maintain stability of the unit.
- If module is to be mounted in the center of the table, order a CX console (centered modesty, pg. 39) for additional support.
- Module width and depth cannot be modified. Reduction in the height of the overall module or riser requires an upcharge.
- When using a 3" riser you can retain the overall height of the module, by adding 3" to the sorting height. For example, an S5-42E6 would become an S5-45E3. Add a \$90 modification charge to the price of the original module.
- Modules with 3" risers are closed in the front and back of the riser and fasten to the console with a locking cam accessed from outside of the module.
- All modules are shipped fully assembled. When getting freight quotes, specify Class 100. If dimensions are required, add 3" to each dimension for packing materials.

Sort Modules

Standard Closed Back, No Riser



S4-36C

MODEL #	WIDTH	SLOTS	HEIGHT	WEIGHT	PRICE
S1-18C	13 ^{1/16}	6	18	34	328
S2-18C	24 ^{3/4}	12	18	51	570
S3-18C	36 ^{7/16}	18	18	74	762
S4-18C	48 ^{1/8}	24	18	92	1,006
S5-18C	59 ^{13/16}	30	18	109	1,258
S6-18C	71 ^{1/2}	36	18	125	1,513
S1-24C	13 ^{1/16}	6	24	40	433
S2-24C	24 ^{3/4}	12	24	58	691
S3-24C	36 ^{7/16}	18	24	86	899
S4-24C	48 ^{1/8}	24	24	107	1,157
S5-24C	59 ^{13/16}	30	24	129	1,430
S6-24C	71 ^{1/2}	36	24	150	1,702
S1-30C	13 ^{1/16}	6	30	44	484
S2-30C	24 ^{3/4}	12	30	67	774
S3-30C	36 ^{7/16}	18	30	98	1,010
S4-30C	48 ^{1/8}	24	30	122	1,298
S5-30C	59 ^{13/16}	30	30	147	1,563
S6-30C	71 ^{1/2}	36	30	173	1,830
S1-36C	13 ^{1/16}	8	36	51	664
S2-36C	24 ^{3/4}	16	36	77	932
S3-36C	36 ^{7/16}	24	36	113	1,166
S4-36C	48 ^{1/8}	32	36	143	1,475
S5-36C	59 ^{13/16}	40	36	172	1,692
S6-36C	71 ^{1/2}	48	36	201	1,906
S1-42C	13 ^{1/16}	8	42	56	681
S2-42C	24 ^{3/4}	16	42	86	979
S3-42C	36 ^{7/16}	24	42	128	1,298
S4-42C	48 ^{1/8}	32	42	158	1,670
S5-42C	59 ^{13/16}	40	42	191	2,057
S6-42C	71 ^{1/2}	48	42	224	2,445
S1-48C	13 ^{1/16}	8	48	62	702
S2-48C	24 ^{3/4}	16	48	95	1,016
S3-48C	36 ^{7/16}	24	48	141	1,428
S4-48C	48 ^{1/8}	32	48	174	1,864
S5-48C	59 ^{13/16}	40	48	210	2,289
S6-48C	71 ^{1/2}	48	48	246	2,710

Depth on all Standard-Size Sort Modules = 12^{7/8}"

Standard Closed Back, 3" Riser



S4-36CE03

MODEL #	WIDTH	SLOTS	HEIGHT	WEIGHT	PRICE
S1-18CE03	13 ^{1/16}	6	21	37	328
S2-18CE03	24 ^{3/4}	12	21	54	570
S3-18CE03	36 ^{7/16}	18	21	77	762
S4-18CE03	48 ^{1/8}	24	21	95	1,006
S5-18CE03	59 ^{13/16}	30	21	112	1,258
S6-18CE03	71 ^{1/2}	36	21	128	1,513

Standard Closed Back, 3" Riser (cont.)

MODEL #	WIDTH	SLOTS	HEIGHT	WEIGHT	PRICE
S1-24CE03	13 ^{1/16}	6	27	43	433
S2-24CE03	24 ^{3/4}	12	27	61	691
S3-24CE03	36 ^{7/16}	18	27	89	899
S4-24CE03	48 ^{1/8}	24	27	110	1,157
S5-24CE03	59 ^{13/16}	30	27	132	1,430
S6-24CE03	71 ^{1/2}	36	27	153	1,702
S1-30CE03	13 ^{1/16}	6	33	47	484
S2-30CE03	24 ^{3/4}	12	33	70	774
S3-30CE03	36 ^{7/16}	18	33	101	1,010
S4-30CE03	48 ^{1/8}	24	33	125	1,298
S5-30CE03	59 ^{13/16}	30	33	150	1,563
S6-30CE03	71 ^{1/2}	36	33	176	1,830
S1-36CE03	13 ^{1/16}	8	39	54	664
S2-36CE03	24 ^{3/4}	16	39	80	932
S3-36CE03	36 ^{7/16}	24	39	116	1,166
S4-36CE03	48 ^{1/8}	32	39	146	1,475
S5-36CE03	59 ^{13/16}	40	39	175	1,692
S6-36CE03	71 ^{1/2}	48	39	204	1,906
S1-42CE03	13 ^{1/16}	8	45	59	681
S2-42CE03	24 ^{3/4}	16	45	89	979
S3-42CE03	36 ^{7/16}	24	45	131	1,298
S4-42CE03	48 ^{1/8}	32	45	161	1,670
S5-42CE03	59 ^{13/16}	40	45	194	2,057
S6-42CE03	71 ^{1/2}	48	45	227	2,445

Depth on all Standard-Size Sort Modules = 12^{7/8}"

For open riser, change model # to P at no additional charge.

Standard Closed Back, 6" Riser



S3-30CE06

MODEL #	WIDTH	SLOTS	HEIGHT	WEIGHT	PRICE
S1-18CE06	13 ^{1/16}	6	24	39	500
S2-18CE06	24 ^{3/4}	12	24	56	764
S3-18CE06	36 ^{7/16}	18	24	81	965
S4-18CE06	48 ^{1/8}	24	24	100	1,236
S5-18CE06	59 ^{13/16}	30	24	122	1,510
S6-18CE06	71 ^{1/2}	36	24	144	1,777
S1-24CE06	13 ^{1/16}	6	30	44	559
S2-24CE06	24 ^{3/4}	12	30	65	857
S3-24CE06	36 ^{7/16}	18	30	95	1,053
S4-24CE06	48 ^{1/8}	24	30	117	1,338
S5-24CE06	59 ^{13/16}	30	30	141	1,635
S6-24CE06	71 ^{1/2}	36	30	165	1,930
S1-30CE06	13 ^{1/16}	6	36	48	690
S2-30CE06	24 ^{3/4}	12	36	73	930
S3-30CE06	36 ^{7/16}	18	36	107	1,084
S4-30CE06	48 ^{1/8}	24	36	132	1,458
S5-30CE06	59 ^{13/16}	30	36	160	1,776
S6-30CE06	71 ^{1/2}	36	36	188	2,094
S1-36CE06	13 ^{1/16}	8	42	56	736

Standard Closed Back, 6" Riser (cont.)

MODEL #	WIDTH	SLOTS	HEIGHT	WEIGHT	PRICE
S2-36CE06	24 ³ / ₄	16	42	84	957
S3-36CE06	36 ⁷ / ₁₆	24	42	122	1,189
S4-36CE06	48 ¹ / ₈	32	42	153	1,509
S5-36CE06	59 ¹³ / ₁₆	40	42	185	1,830
S6-36CE06	71 ¹ / ₂	48	42	218	2,151
S1-42CE06	13 ¹ / ₁₆	8	48	64	775
S2-42CE06	24 ³ / ₄	16	48	95	1,016
S3-42CE06	36 ⁷ / ₁₆	24	48	138	1,428
S4-42CE06	48 ¹ / ₈	32	48	173	1,864
S5-42CE06	59 ¹³ / ₁₆	40	48	185	2,289
S6-42CE06	71 ¹ / ₂	48	48	197	2,710

Depth on all Standard-Size Sort Modules = 12⁷/₈"
 For open riser, change model # to P at no additional charge.

Standard Closed Back, 12" Riser



S4-24CE12

MODEL #	WIDTH	SLOTS	HEIGHT	WEIGHT	PRICE
S1-18CE12	13 ¹ / ₁₆	6	30	44	554
S2-18CE12	24 ³ / ₄	12	30	63	845
S3-18CE12	36 ⁷ / ₁₆	18	30	89	1,057
S4-18CE12	48 ¹ / ₈	24	30	110	1,361
S5-18CE12	59 ¹³ / ₁₆	30	30	134	1,646
S6-18CE12	71 ¹ / ₂	36	30	158	1,941
S1-24CE12	13 ¹ / ₁₆	6	36	48	690
S2-24CE12	24 ³ / ₄	12	36	70	919
S3-24CE12	36 ⁷ / ₁₆	18	36	101	1,145
S4-24CE12	48 ¹ / ₈	24	36	125	1,466
S5-24CE12	59 ¹³ / ₁₆	30	36	154	1,823
S6-24CE12	71 ¹ / ₂	36	36	182	2,181
S1-30CE12	13 ¹ / ₁₆	6	42	55	705
S2-30CE12	24 ³ / ₄	12	42	79	951
S3-30CE12	36 ⁷ / ₁₆	18	42	113	1,196
S4-30CE12	48 ¹ / ₈	24	42	142	1,520
S5-30CE12	59 ¹³ / ₁₆	30	42	173	1,939
S6-30CE12	71 ¹ / ₂	36	42	205	2,356
S1-36CE12	13 ¹ / ₁₆	8	48	62	737
S2-36CE12	24 ³ / ₄	16	48	88	984
S3-36CE12	36 ⁷ / ₁₆	24	48	125	1,250
S4-36CE12	48 ¹ / ₈	32	48	157	1,575
S5-36CE12	59 ¹³ / ₁₆	40	48	193	2,054
S6-36CE12	71 ¹ / ₂	48	48	228	2,528

Depth on all Standard-Size Sort Modules = 12⁷/₈"
 For open riser, change model # to P at no additional charge.

Standard Closed Back, 18" Riser



S4-30CE18

MODEL #	WIDTH	SLOTS	HEIGHT	WEIGHT	PRICE
S1-18CE18	13 ¹ / ₁₆	6	36	47	699
S2-18CE18	24 ³ / ₄	12	36	68	912
S3-18CE18	36 ⁷ / ₁₆	18	36	98	1,140
S4-18CE18	48 ¹ / ₈	24	36	120	1,454
S5-18CE18	59 ¹³ / ₁₆	30	36	147	1,764
S6-18CE18	71 ¹ / ₂	36	36	176	2,077
S1-24CE18	13 ¹ / ₁₆	6	42	54	717
S2-24CE18	24 ³ / ₄	12	42	77	944
S3-24CE18	36 ⁷ / ₁₆	18	42	110	1,176
S4-24CE18	48 ¹ / ₈	24	42	135	1,500
S5-24CE18	59 ¹³ / ₁₆	30	42	167	1,864
S6-24CE18	71 ¹ / ₂	36	42	198	2226
S1-30CE18	13 ¹ / ₁₆	6	48	61	742
S2-30CE18	24 ³ / ₄	12	48	86	979
S3-30CE18	36 ⁷ / ₁₆	18	48	122	1,213
S4-30CE18	48 ¹ / ₈	24	48	152	1,548
S5-30CE18	59 ¹³ / ₁₆	30	48	186	1,959
S6-30CE18	71 ¹ / ₂	36	48	221	2,375

Depth on all Standard-Size Sort Modules = 12⁷/₈"
 For open riser, change model # to P at no additional charge.

Standard Open Back, No Riser



S4-300

MODEL #	WIDTH	SLOTS	HEIGHT	WEIGHT	PRICE
S1-180	13 ¹ / ₁₆	6	18	34	328
S2-180	24 ³ / ₄	12	18	51	570
S3-180	36 ⁷ / ₁₆	18	18	74	762
S4-180	48 ¹ / ₈	24	18	92	1,006
S5-180	59 ¹³ / ₁₆	30	18	109	1,258
S6-180	71 ¹ / ₂	36	18	125	1,513
S1-240	13 ¹ / ₁₆	6	24	40	433
S2-240	24 ³ / ₄	12	24	58	691
S3-240	36 ⁷ / ₁₆	18	24	86	899
S4-240	48 ¹ / ₈	24	24	107	1,157
S5-240	59 ¹³ / ₁₆	30	24	129	1,430
S6-240	71 ¹ / ₂	36	24	150	1,702
S1-300	13 ¹ / ₁₆	6	30	44	484
S2-300	24 ³ / ₄	12	30	67	774
S3-300	36 ⁷ / ₁₆	18	30	98	1,010
S4-300	48 ¹ / ₈	24	30	122	1,298
S5-300	59 ¹³ / ₁₆	30	30	147	1,563
S6-300	71 ¹ / ₂	36	30	173	1,830
S1-360	13 ¹ / ₁₆	8	36	51	664
S2-360	24 ³ / ₄	16	36	77	932
S3-360	36 ⁷ / ₁₆	24	36	113	1,166
S4-360	48 ¹ / ₈	32	36	143	1,475
S5-360	59 ¹³ / ₁₆	40	36	172	1,692
S6-360	71 ¹ / ₂	48	36	201	1,906
S1-420	13 ¹ / ₁₆	8	42	56	681

Standard Open Back, No Riser (cont.)

MODEL #	WIDTH	SLOTS	HEIGHT	WEIGHT	PRICE
S2-420	24 ^{3/4}	16	42	86	979
S3-420	36 ^{7/16}	24	42	128	1,298
S4-420	48 ^{1/8}	32	42	158	1,670
S5-420	59 ^{13/16}	40	42	191	2,057
S6-420	71 ^{1/2}	48	42	224	2,445
S1-480	13 ^{1/16}	8	48	62	702
S2-480	24 ^{3/4}	16	48	95	1,016
S3-480	36 ^{7/16}	24	48	141	1,428
S4-480	48 ^{1/8}	32	48	174	1,864
S5-480	59 ^{13/16}	40	48	210	2,289
S6-480	71 ^{1/2}	48	48	246	2,710

Depth on all Standard-Size Sort Modules = 12^{7/8}"
Open back risers are not available on open back modules.

Standard Open Back, 3" Riser

S4-300E03

MODEL #	WIDTH	SLOTS	HEIGHT	WEIGHT	PRICE
S1-180E03	13 ^{1/16}	6	21	36	328
S2-180E03	24 ^{3/4}	12	21	53	570
S3-180E03	36 ^{7/16}	18	21	78	762
S4-180E03	48 ^{1/8}	24	21	97	1,006
S5-180E03	59 ^{13/16}	30	21	119	1,258
S6-180E03	71 ^{1/2}	36	21	141	1,513
S1-240E03	13 ^{1/16}	6	27	41	433
S2-240E03	24 ^{3/4}	12	27	62	691
S3-240E03	36 ^{7/16}	18	27	92	899
S4-240E03	48 ^{1/8}	24	27	114	1,157
S5-240E03	59 ^{13/16}	30	27	138	1,430
S6-240E03	71 ^{1/2}	36	27	162	1,702
S1-300E03	13 ^{1/16}	6	33	45	484
S2-300E03	24 ^{3/4}	12	33	70	774
S3-300E03	36 ^{7/16}	18	33	104	1,010
S4-300E03	48 ^{1/8}	24	33	129	1,298
S5-300E03	59 ^{13/16}	30	33	157	1,563
S6-300E03	71 ^{1/2}	36	33	185	1,830
S1-360E03	13 ^{1/16}	8	39	53	664
S2-360E03	24 ^{3/4}	16	39	81	932
S3-360E03	36 ^{7/16}	24	39	119	1,166
S4-360E03	48 ^{1/8}	32	39	150	1,475
S5-360E03	59 ^{13/16}	40	39	182	1,692
S6-360E03	71 ^{1/2}	48	39	215	1,906
S1-420E03	13 ^{1/16}	8	45	61	681
S2-420E03	24 ^{3/4}	16	45	92	979
S3-420E03	36 ^{7/16}	24	45	135	1,298
S4-420E03	48 ^{1/8}	32	45	170	1,670
S5-420E03	59 ^{13/16}	40	45	182	2,057
S6-420E03	71 ^{1/2}	48	45	194	2,445

Depth on all Standard-Size Sort Modules = 12^{7/8}"
Open back risers are not available on open back modules.

Standard Open Back, 6" Riser

S4-300E06

MODEL #	WIDTH	SLOTS	HEIGHT	WEIGHT	PRICE
S1-180E06	13 ^{1/16}	6	24	39	500
S2-180E06	24 ^{3/4}	12	24	56	764
S3-180E06	36 ^{7/16}	18	24	81	965
S4-180E06	48 ^{1/8}	24	24	100	1,236
S5-180E06	59 ^{13/16}	30	24	122	1,510
S6-180E06	71 ^{1/2}	36	24	144	1,777
S1-240E06	13 ^{1/16}	6	30	44	559
S2-240E06	24 ^{3/4}	12	30	65	857
S3-240E06	36 ^{7/16}	18	30	95	1,053
S4-240E06	48 ^{1/8}	24	30	117	1,338
S5-240E06	59 ^{13/16}	30	30	141	1,635
S6-240E06	71 ^{1/2}	36	30	165	1,930
S1-300E06	13 ^{1/16}	6	36	48	690
S2-300E06	24 ^{3/4}	12	36	73	930
S3-300E06	36 ^{7/16}	18	36	107	1,084
S4-300E06	48 ^{1/8}	24	36	132	1,458
S5-300E06	59 ^{13/16}	30	36	160	1,776
S6-300E06	71 ^{1/2}	36	36	188	2,094
S1-360E06	13 ^{1/16}	8	42	56	736
S2-360E06	24 ^{3/4}	16	42	84	957
S3-360E06	36 ^{7/16}	24	42	122	1,189
S4-360E06	48 ^{1/8}	32	42	153	1,509
S5-360E06	59 ^{13/16}	40	42	185	1,830
S6-360E06	71 ^{1/2}	48	42	218	2,151
S1-420E06	13 ^{1/16}	8	48	64	775
S2-420E06	24 ^{3/4}	16	48	95	1,016
S3-420E06	36 ^{7/16}	24	48	138	1,428
S4-420E06	48 ^{1/8}	32	48	173	1,864
S5-420E06	59 ^{13/16}	40	48	185	2,289
S6-420E06	71 ^{1/2}	48	48	197	2,710

Depth on all Standard-Size Sort Modules = 12^{7/8}"
Open back risers are not available on open back modules.

Standard Open Back, 12" Riser

S3-240E12

MODEL #	WIDTH	SLOTS	HEIGHT	WEIGHT	PRICE
S1-180E12	13 ^{1/16}	6	30	44	554
S2-180E12	24 ^{3/4}	12	30	63	845
S3-180E12	36 ^{7/16}	18	30	89	1,057
S4-180E12	48 ^{1/8}	24	30	110	1,361
S5-180E12	59 ^{13/16}	30	30	134	1,646
S6-180E12	71 ^{1/2}	36	30	158	1,941
S1-240E12	13 ^{1/16}	6	36	48	690
S2-240E12	24 ^{3/4}	12	36	70	919
S3-240E12	36 ^{7/16}	18	36	101	1,145
S4-240E12	48 ^{1/8}	24	36	125	1,466
S5-240E12	59 ^{13/16}	30	36	154	1,826
S6-240E12	71 ^{1/2}	36	36	182	2,181
S1-300E12	13 ^{1/16}	6	42	55	705

Standard Open Back, 12" Riser (cont.)

MODEL #	WIDTH	SLOTS	HEIGHT	WEIGHT	PRICE
S2-30OE12	24 ³ / ₄	12	42	79	951
S3-30OE12	36 ⁷ / ₁₆	18	42	113	1,196
S4-30OE12	48 ¹ / ₈	24	42	142	1,520
S5-30OE12	59 ¹³ / ₁₆	30	42	173	1,939
S6-30OE12	71 ¹ / ₂	36	42	205	2,356
S1-36OE12	13 ¹ / ₁₆	6	48	62	717
S2-36OE12	24 ³ / ₄	12	48	88	984
S3-36OE12	36 ⁷ / ₁₆	18	48	125	1,250
S4-36OE12	48 ¹ / ₈	24	48	157	1,575
S5-36OE12	59 ¹³ / ₁₆	30	48	193	2,054
S6-36OE12	71 ¹ / ₂	36	48	228	2,528

Depth on all Standard-Size Sort Modules = 12⁷/₈"
 Open back risers are not available on open back modules.

Standard Open Back, 18" Riser



S4-24OE18

MODEL #	WIDTH	SLOTS	HEIGHT	WEIGHT	PRICE
S1-18OE18	13 ¹ / ₁₆	6	36	47	699
S2-18OE18	24 ³ / ₄	12	36	68	912
S3-18OE18	36 ⁷ / ₁₆	18	36	98	1,140
S4-18OE18	48 ¹ / ₈	24	36	120	1,454
S5-18OE18	59 ¹³ / ₁₆	30	36	147	1,764
S6-18OE18	71 ¹ / ₂	36	36	176	2,077
S1-24OE18	13 ¹ / ₁₆	6	42	54	717
S2-24OE18	24 ³ / ₄	12	42	77	944
S3-24OE18	36 ⁷ / ₁₆	18	42	110	1,176
S4-24OE18	48 ¹ / ₈	24	42	135	1,500
S5-24OE18	59 ¹³ / ₁₆	30	42	167	1,864
S6-24OE18	71 ¹ / ₂	36	42	198	2,226
S1-30OE18	13 ¹ / ₁₆	6	48	61	742
S2-30OE18	24 ³ / ₄	12	48	86	979
S3-30OE18	36 ⁷ / ₁₆	18	48	122	1,213
S4-30OE18	48 ¹ / ₈	24	48	152	1,548
S5-30OE18	59 ¹³ / ₁₆	30	48	186	1,959
S6-30OE18	71 ¹ / ₂	36	48	221	2,375

Depth on all Standard-Size Sort Modules = 12⁷/₈"
 Open back risers are not available on open back modules.

Standard Plexiglass Back, No Riser



S4-36P

MODEL #	WIDTH	SLOTS	HEIGHT	WEIGHT	PRICE
S1-18P	13 ¹ / ₁₆	6	18	34	410
S2-18P	24 ³ / ₄	12	18	51	671
S3-18P	36 ⁷ / ₁₆	18	18	67	881
S4-18P	48 ¹ / ₈	24	18	84	1,201
S5-18P	59 ¹³ / ₁₆	30	18	99	1,473
S6-18P	71 ¹ / ₂	36	18	114	1,746
S1-24P	13 ¹ / ₁₆	6	24	40	522
S2-24P	24 ³ / ₄	12	24	58	801
S3-24P	36 ⁷ / ₁₆	18	24	78	1,031

Standard Plexiglass Back, No Riser (cont.)

MODEL #	WIDTH	SLOTS	HEIGHT	WEIGHT	PRICE
S4-24P	48 ¹ / ₈	24	24	97	1,374
S5-24P	59 ¹³ / ₁₆	30	24	117	1,672
S6-24P	71 ¹ / ₂	36	24	136	1,969
S1-30P	13 ¹ / ₁₆	6	30	44	576
S2-30P	24 ³ / ₄	12	30	67	895
S3-30P	36 ⁷ / ₁₆	18	30	89	1,162
S4-30P	48 ¹ / ₈	24	30	111	1,538
S5-30P	59 ¹³ / ₁₆	30	30	134	1,834
S6-30P	71 ¹ / ₂	36	30	157	2,128
S1-36P	13 ¹ / ₁₆	8	36	51	797
S2-36P	24 ³ / ₄	16	36	77	1,066
S3-36P	36 ⁷ / ₁₆	24	36	103	1,331
S4-36P	48 ¹ / ₈	32	36	130	1,741
S5-36P	59 ¹³ / ₁₆	40	36	156	1,992
S6-36P	71 ¹ / ₂	48	36	183	2,241
S1-42P	13 ¹ / ₁₆	8	42	56	802
S2-42P	24 ³ / ₄	16	42	86	939
S3-42P	36 ⁷ / ₁₆	24	42	116	1,482
S4-42P	48 ¹ / ₈	32	42	144	2,128
S5-42P	59 ¹³ / ₁₆	40	42	174	2,386
S6-42P	71 ¹ / ₂	48	42	204	2,583
S1-48P	13 ¹ / ₁₆	8	48	62	814
S2-48P	24 ³ / ₄	16	48	95	1,176
S3-48P	36 ⁷ / ₁₆	24	48	128	1,628
S4-48P	48 ¹ / ₈	32	48	158	2,176
S5-48P	59 ¹³ / ₁₆	40	48	191	2,699
S6-48P	71 ¹ / ₂	48	48	224	3,113

Depth on all Standard-Size Sort Modules = 12⁷/₈"

Standard Plexiglass Back, 3" Riser



S4-36PE03

MODEL #	WIDTH	SLOTS	HEIGHT	WEIGHT	PRICE
S1-18PE03	13 ¹ / ₁₆	6	21	37	410
S2-18PE03	24 ³ / ₄	12	21	54	671
S3-18PE03	36 ⁷ / ₁₆	18	21	70	881
S4-18PE03	48 ¹ / ₈	24	21	87	1,201
S5-18PE03	59 ¹³ / ₁₆	30	21	102	1,473
S6-18PE03	71 ¹ / ₂	36	21	117	1,746
S1-24PE03	13 ¹ / ₁₆	6	27	43	522
S2-24PE03	24 ³ / ₄	12	27	61	801
S3-24PE03	36 ⁷ / ₁₆	18	27	81	1,031
S4-24PE03	48 ¹ / ₈	24	27	100	1,374
S5-24PE03	59 ¹³ / ₁₆	30	27	120	1,672
S6-24PE03	71 ¹ / ₂	36	27	139	1,969
S1-30PE03	13 ¹ / ₁₆	6	33	47	576
S2-30PE03	24 ³ / ₄	12	33	70	895
S3-30PE03	36 ⁷ / ₁₆	18	33	92	1,162
S4-30PE03	48 ¹ / ₈	24	33	114	1,538
S5-30PE03	59 ¹³ / ₁₆	30	33	137	1,834
S6-30PE03	71 ¹ / ₂	36	33	160	2,128

Standard Plexiglass Back, 3" Riser (cont.)

MODEL #	WIDTH	SLOTS	HEIGHT	WEIGHT	PRICE
S1-36PE03	13 ¹ / ₁₆	8	39	54	797
S2-36PE03	24 ³ / ₄	16	39	80	1,066
S3-36PE03	36 ⁷ / ₁₆	24	39	106	1,331
S4-36PE03	48 ¹ / ₈	32	39	133	1,741
S5-36PE03	59 ¹³ / ₁₆	40	39	159	1,992
S6-36PE03	71 ¹ / ₂	48	39	186	2,241
S1-42PE03	13 ¹ / ₁₆	8	45	59	802
S2-42PE03	24 ³ / ₄	16	45	89	939
S3-42PE03	36 ⁷ / ₁₆	24	45	119	1,482
S4-42PE03	48 ¹ / ₈	32	45	147	2,128
S5-42PE03	59 ¹³ / ₁₆	40	45	177	2,386
S6-42PE03	71 ¹ / ₂	48	45	207	2,583

Depth on all Standard-Size Sort Modules = 12⁷/₈"
 For open riser, change model # to P (for pass-through)
 at no additional charge.

Standard Plexiglass Back, 6" Riser



S4-30PE06

MODEL #	WIDTH	SLOTS	HEIGHT	WEIGHT	PRICE
S1-18PE06	13 ¹ / ₁₆	6	24	39	580
S2-18PE06	24 ³ / ₄	12	24	56	865
S3-18PE06	36 ⁷ / ₁₆	18	24	74	1,082
S4-18PE06	48 ¹ / ₈	24	24	91	1,435
S5-18PE06	59 ¹³ / ₁₆	30	24	111	1,720
S6-18PE06	71 ¹ / ₂	36	24	131	2,013
S1-24PE06	13 ¹ / ₁₆	6	30	44	646
S2-24PE06	24 ³ / ₄	12	30	65	965
S3-24PE06	36 ⁷ / ₁₆	18	30	86	1,182
S4-24PE06	48 ¹ / ₈	24	30	106	1,559
S5-24PE06	59 ¹³ / ₁₆	30	30	128	1,876
S6-24PE06	71 ¹ / ₂	36	30	150	2,199
S1-30PE06	13 ¹ / ₁₆	6	36	48	781
S2-30PE06	24 ³ / ₄	12	36	73	1,054
S3-30PE06	36 ⁷ / ₁₆	18	36	97	1,235
S4-30PE06	48 ¹ / ₈	24	36	120	1,701
S5-30PE06	59 ¹³ / ₁₆	30	36	145	2,050
S6-30PE06	71 ¹ / ₂	36	36	171	2,396
S1-36PE06	13 ¹ / ₁₆	8	42	56	831
S2-36PE06	24 ³ / ₄	16	42	84	1,088
S3-36PE06	36 ⁷ / ₁₆	24	42	111	1,358
S4-36PE06	48 ¹ / ₈	32	42	139	1,772
S5-36PE06	59 ¹³ / ₁₆	40	42	168	2,128
S6-36PE06	71 ¹ / ₂	48	42	198	2,491
S1-42PE06	13 ¹ / ₁₆	8	48	64	881
S2-42PE06	24 ³ / ₄	16	48	95	1,127
S3-42PE06	36 ⁷ / ₁₆	24	48	125	1,476
S4-42PE06	48 ¹ / ₈	32	48	157	1,840

Standard Plexiglass Back, 6" Riser (cont.)

MODEL #	WIDTH	SLOTS	HEIGHT	WEIGHT	PRICE
S5-42PE06	59 ¹³ / ₁₆	40	48	191	2,212
S6-42PE06	71 ¹ / ₂	48	48	226	2,815

Depth on all Standard-Size Sort Modules = 12⁷/₈"
 For open riser, change model # to P (for pass-through)
 at no additional charge.

Standard Plexiglass Back, 12" Riser



S4-30PE12

MODEL #	WIDTH	SLOTS	HEIGHT	WEIGHT	PRICE
S1-18PE12	13 ¹ / ₁₆	6	30	44	634
S2-18PE12	24 ³ / ₄	12	30	63	943
S3-18PE12	36 ⁷ / ₁₆	18	30	81	1,172
S4-18PE12	48 ¹ / ₈	24	30	100	1,556
S5-18PE12	59 ¹³ / ₁₆	30	30	122	1,862
S6-18PE12	71 ¹ / ₂	36	30	144	2,171
S1-24PE12	13 ¹ / ₁₆	6	36	48	777
S2-24PE12	24 ³ / ₄	12	36	70	1,027
S3-24PE12	36 ⁷ / ₁₆	18	36	92	1,276
S4-24PE12	48 ¹ / ₈	24	36	114	1,684
S5-24PE12	59 ¹³ / ₁₆	30	36	140	2,067
S6-24PE12	71 ¹ / ₂	36	36	165	2,449
S1-30PE12	13 ¹ / ₁₆	6	42	55	797
S2-30PE12	24 ³ / ₄	12	42	79	1,073
S3-30PE12	36 ⁷ / ₁₆	18	42	103	1,344
S4-30PE12	48 ¹ / ₈	24	42	129	1,763
S5-30PE12	59 ¹³ / ₁₆	30	42	157	2,207
S6-30PE12	71 ¹ / ₂	36	42	186	2,652
S1-36PE12	13 ¹ / ₁₆	8	48	62	818
S2-36PE12	24 ³ / ₄	16	48	88	1,115
S3-36PE12	36 ⁷ / ₁₆	24	48	114	1,418
S4-36PE12	48 ¹ / ₈	32	48	143	1,840
S5-36PE12	59 ¹³ / ₁₆	40	48	175	2,354
S6-36PE12	71 ¹ / ₂	48	48	207	2,864

Depth on all Standard-Size Sort Modules = 12⁷/₈"
 For open riser, change model # to P (for pass-through)
 at no additional charge.

Standard Plexiglass Back, 18" Riser



S4-24PE18

MODEL #	WIDTH	SLOTS	HEIGHT	WEIGHT	PRICE
S1-18PE18	13 ¹ / ₁₆	6	36	47	780
S2-18PE18	24 ³ / ₄	12	36	68	1,010
S3-18PE18	36 ⁷ / ₁₆	18	36	98	1,256
S4-18PE18	48 ¹ / ₈	24	36	109	1,650
S5-18PE18	59 ¹³ / ₁₆	30	36	134	1,980
S6-18PE18	71 ¹ / ₂	36	36	160	2,309
S1-24PE18	13 ¹ / ₁₆	6	42	59	807
S2-24PE18	24 ³ / ₄	12	42	77	1,056
S3-24PE18	36 ⁷ / ₁₆	18	42	95	1,307
S4-24PE18	48 ¹ / ₈	24	42	123	1,720
S5-24PE18	59 ¹³ / ₁₆	30	42	152	2,105

Standard Plexiglass Back, 18" Riser (cont.)

MODEL #	WIDTH	SLOTS	HEIGHT	WEIGHT	PRICE
S6-24PE18	71 ¹ / ₂	36	42	180	2,493
S1-30PE18	13 ¹ / ₁₆	6	48	54	832
S2-30PE18	24 ³ / ₄	12	48	77	1,094
S3-30PE18	36 ⁷ / ₁₆	18	48	100	1,363
S4-30PE18	48 ¹ / ₈	24	48	138	1,792
S5-30PE18	59 ¹³ / ₁₆	30	48	169	2,233
S6-30PE18	71 ¹ / ₂	36	48	201	2,676

Depth on all Standard-Size Sort Modules = 12⁷/₈"
 For open riser, change model # to P (for pass-through)
 at no additional charge.

Legal Closed Back, No Riser



L4-36C

MODEL #	WIDTH	SLOTS	HEIGHT	WEIGHT	PRICE
L1-18C	13 ¹ / ₁₆	6	18	40	446
L2-18C	24 ³ / ₄	12	18	59	712
L3-18C	36 ⁷ / ₁₆	18	18	87	910
L4-18C	48 ¹ / ₈	24	18	109	1,169
L5-18C	59 ¹³ / ₁₆	30	18	131	1,423
L6-18C	71 ¹ / ₂	36	18	153	1,682
L1-24C	13 ¹ / ₁₆	6	24	46	479
L2-24C	24 ³ / ₄	12	24	69	764
L3-24C	36 ⁷ / ₁₆	18	24	103	983
L4-24C	48 ¹ / ₈	24	24	129	1,258
L5-24C	59 ¹³ / ₁₆	30	24	155	1,537
L6-24C	71 ¹ / ₂	36	24	182	1,813
L1-30C	13 ¹ / ₁₆	6	30	53	546
L2-30C	24 ³ / ₄	12	30	80	873
L3-30C	36 ⁷ / ₁₆	18	30	119	1,126
L4-30C	48 ¹ / ₈	24	30	147	1,443
L5-30C	59 ¹³ / ₁₆	30	30	178	1,759
L6-30C	71 ¹ / ₂	36	30	208	2,071
L1-36C	13 ¹ / ₁₆	8	36	61	649
L2-36C	24 ³ / ₄	16	36	92	984
L3-36C	36 ⁷ / ₁₆	24	36	136	1,292
L4-36C	48 ¹ / ₈	32	36	172	1,660
L5-36C	59 ¹³ / ₁₆	40	36	207	2,022
L6-36C	71 ¹ / ₂	48	36	242	2,390
L1-42C	13 ¹ / ₁₆	8	42	68	702
L2-42C	24 ³ / ₄	16	42	103	1,030
L3-42C	36 ⁷ / ₁₆	24	42	153	1,356
L4-42C	48 ¹ / ₈	32	42	191	1,743
L5-42C	59 ¹³ / ₁₆	40	42	231	2,127
L6-42C	71 ¹ / ₂	48	42	271	2,511
L1-48C	13 ¹ / ₁₆	8	48	76	761
L2-48C	24 ³ / ₄	16	48	114	943
L3-48C	36 ⁷ / ₁₆	24	48	168	1,486
L4-48C	48 ¹ / ₈	32	48	210	1,916
L5-48C	59 ¹³ / ₁₆	40	48	242	2,333
L6-48C	71 ¹ / ₂	48	48	300	2,757

Depth on all Legal-Size Sort Modules = 16⁷/₈"

Legal Closed Back, 3" Riser



L4-36CE03

MODEL #	WIDTH	SLOTS	HEIGHT	WEIGHT	PRICE
L1-18CE03	13 ¹ / ₁₆	6	21	43	446
L2-18CE03	24 ³ / ₄	12	21	62	712
L3-18CE03	36 ⁷ / ₁₆	18	21	90	910
L4-18CE03	48 ¹ / ₈	24	21	112	1,169
L5-18CE03	59 ¹³ / ₁₆	30	21	134	1,423
L6-18CE03	71 ¹ / ₂	36	21	156	1,682
L1-24CE03	13 ¹ / ₁₆	6	27	49	479
L2-24CE03	24 ³ / ₄	12	27	72	764
L3-24CE03	36 ⁷ / ₁₆	18	27	106	983
L4-24CE03	48 ¹ / ₈	24	27	132	1,258
L5-24CE03	59 ¹³ / ₁₆	30	27	158	1,537
L6-24CE03	71 ¹ / ₂	36	27	185	1,813
L1-30CE03	13 ¹ / ₁₆	6	33	56	546
L2-30CE03	24 ³ / ₄	12	33	83	873
L3-30CE03	36 ⁷ / ₁₆	18	33	122	1,126
L4-30CE03	48 ¹ / ₈	24	33	150	1,443
L5-30CE03	59 ¹³ / ₁₆	30	33	181	1,759
L6-30CE03	71 ¹ / ₂	36	33	211	2,071
L1-36CE03	13 ¹ / ₁₆	8	39	64	649
L2-36CE03	24 ³ / ₄	16	39	95	984
L3-36CE03	36 ⁷ / ₁₆	24	39	139	1,292
L4-36CE03	48 ¹ / ₈	32	39	175	1,660
L5-36CE03	59 ¹³ / ₁₆	40	39	210	2,022
L6-36CE03	71 ¹ / ₂	48	39	245	2,390
L1-42CE03	13 ¹ / ₁₆	8	45	71	702
L2-42CE03	24 ³ / ₄	16	45	106	1,030
L3-42CE03	36 ⁷ / ₁₆	24	45	156	1,356
L4-42CE03	48 ¹ / ₈	32	45	194	1,743
L5-42CE03	59 ¹³ / ₁₆	40	45	234	2,127
L6-42CE03	71 ¹ / ₂	48	45	274	2,511

Depth on all Legal-Size Sort Modules = 16⁷/₈"
 For open riser, change model # to P (for pass-through)
 at no additional charge.

Legal Closed Back, 6" Riser



L4-24CE06

MODEL #	WIDTH	SLOTS	HEIGHT	WEIGHT	PRICE
L1-18CE06	13 ¹ / ₁₆	6	24	45	557
L2-18CE06	24 ³ / ₄	12	24	67	857
L3-18CE06	36 ⁷ / ₁₆	18	24	97	1,057
L4-18CE06	48 ¹ / ₈	24	24	120	1,243
L5-18CE06	59 ¹³ / ₁₆	30	24	145	1,604
L6-18CE06	71 ¹ / ₂	36	24	171	1,864
L1-24CE06	13 ¹ / ₁₆	6	30	52	632
L2-24CE06	24 ³ / ₄	12	30	77	977
L3-24CE06	36 ⁷ / ₁₆	18	30	112	1,203
L4-24CE06	48 ¹ / ₈	24	30	140	1,534
L5-24CE06	59 ¹³ / ₁₆	30	30	169	1,834
L6-24CE06	71 ¹ / ₂	36	30	200	2,139
L1-30CE06	13 ¹ / ₁₆	6	36	58	689

Legal Closed Back, 6" Riser (cont.)

MODEL #	WIDTH	SLOTS	HEIGHT	WEIGHT	PRICE
L2-30CE06	24 ^{3/4}	12	36	87	1,010
L3-30CE06	36 ^{7/16}	18	36	128	1,264
L4-30CE06	48 ^{1/8}	24	36	158	1,614
L5-30CE06	59 ^{13/16}	30	36	193	1,916
L6-30CE06	71 ^{1/2}	36	36	227	2,230
L1-36CE06	13 ^{1/16}	8	42	67	760
L2-36CE06	24 ^{3/4}	16	42	100	1,139
L3-36CE06	36 ^{7/16}	24	42	146	1,449
L4-36CE06	48 ^{1/8}	32	42	183	1,773
L5-36CE06	59 ^{13/16}	40	42	221	2,125
L6-36CE06	71 ^{1/2}	48	42	261	2,464
L1-42CE06	13 ^{1/16}	8	48	76	869
L2-42CE06	24 ^{3/4}	16	48	113	1,328
L3-42CE06	36 ^{7/16}	24	48	166	1,708
L4-42CE06	48 ^{1/8}	32	48	207	2,125
L5-42CE06	59 ^{13/16}	40	48	221	2,368
L6-42CE06	71 ^{1/2}	48	48	237	2,760

Depth on all Legal-Size Sort Modules = 16^{7/8}"

For open riser, change model # to P (for pass-through) at no additional charge.

Legal Closed Back, 18" Riser

L4-30CE18

MODEL #	WIDTH	SLOTS	HEIGHT	WEIGHT	PRICE
L1-18CE18	13 ^{1/16}	6	36	57	739
L2-18CE18	24 ^{3/4}	12	36	81	966
L3-18CE18	36 ^{7/16}	18	36	117	1,182
L4-18CE18	48 ^{1/8}	24	36	142	1,506
L5-18CE18	59 ^{13/16}	30	36	176	1,833
L6-18CE18	71 ^{1/2}	36	36	209	2,070
L1-24CE18	13 ^{1/16}	6	42	64	759
L2-24CE18	24 ^{3/4}	12	42	91	1,019
L3-24CE18	36 ^{7/16}	18	42	131	1,256
L4-24CE18	48 ^{1/8}	24	42	161	1,600
L5-24CE18	59 ^{13/16}	30	42	198	1,905
L6-24CE18	71 ^{1/2}	36	42	237	2,208
L1-30CE18	13 ^{1/16}	6	48	70	816
L2-30CE18	24 ^{3/4}	12	48	101	1,127
L3-30CE18	36 ^{7/16}	18	48	145	1,392
L4-30CE18	48 ^{1/8}	24	48	180	1,775
L5-30CE18	59 ^{13/16}	30	48	221	2,117
L6-30CE18	71 ^{1/2}	36	48	263	2,459

Depth on all Legal-Size Sort Modules = 16^{7/8}"

For open riser, change model # to P at no additional charge.

Legal Closed Back, 12" Riser

L4-30CE12

MODEL #	WIDTH	SLOTS	HEIGHT	WEIGHT	PRICE
L1-18CE12	13 ^{1/16}	6	30	52	630
L2-18CE12	24 ^{3/4}	12	30	74	962
L3-18CE12	36 ^{7/16}	18	30	107	1,177
L4-18CE12	48 ^{1/8}	24	30	131	1,317
L5-18CE12	59 ^{13/16}	30	30	161	1,786
L6-18CE12	71 ^{1/2}	36	30	191	2,071
L1-24CE12	13 ^{1/16}	6	36	59	709
L2-24CE12	24 ^{3/4}	12	36	85	1,001
L3-24CE12	36 ^{7/16}	18	36	121	1,226
L4-24CE12	48 ^{1/8}	24	36	150	1,566
L5-24CE12	59 ^{13/16}	30	36	184	1,868
L6-24CE12	71 ^{1/2}	36	36	218	2,175
L1-30CE12	13 ^{1/16}	6	42	65	726
L2-30CE12	24 ^{3/4}	12	42	95	1,055
L3-30CE12	36 ^{7/16}	18	42	136	1,308
L4-30CE12	48 ^{1/8}	24	42	169	1,664
L5-30CE12	59 ^{13/16}	30	42	207	1,986
L6-30CE12	71 ^{1/2}	36	42	244	2,308
L1-36CE12	13 ^{1/16}	8	48	70	793
L2-36CE12	24 ^{3/4}	16	48	105	1,162
L3-36CE12	36 ^{7/16}	24	48	153	1,458
L4-36CE12	48 ^{1/8}	32	48	189	1,840
L5-36CE12	59 ^{13/16}	40	48	230	2,199
L6-36CE12	71 ^{1/2}	48	48	271	2,550

Depth on all Legal-Size Sort Modules = 16^{7/8}"

For open riser, change model # to P (for pass-through) at no additional charge.

Legal Open Back, No Riser

L4-30O

MODEL #	WIDTH	SLOTS	HEIGHT	WEIGHT	PRICE
L1-18O	13 ^{1/16}	6	18	40	446
L2-18O	24 ^{3/4}	12	18	59	712
L3-18O	36 ^{7/16}	18	18	87	910
L4-18O	48 ^{1/8}	24	18	109	1,169
L5-18O	59 ^{13/16}	30	18	131	1,423
L6-18O	71 ^{1/2}	36	18	153	1,682
L1-24O	13 ^{1/16}	6	24	46	479
L2-24O	24 ^{3/4}	12	24	69	764
L3-24O	36 ^{7/16}	18	24	103	983
L4-24O	48 ^{1/8}	24	24	129	1,258
L5-24O	59 ^{13/16}	30	24	155	1,537
L6-24O	71 ^{1/2}	36	24	182	1,813
L1-30O	13 ^{1/16}	6	30	53	546
L2-30O	24 ^{3/4}	12	30	80	873
L3-30O	36 ^{7/16}	18	30	119	1,126
L4-30O	48 ^{1/8}	24	30	147	1,443
L5-30O	59 ^{13/16}	30	30	178	1,759
L6-30O	71 ^{1/2}	36	30	208	2,071
L1-36O	13 ^{1/16}	8	36	61	649
L2-36O	24 ^{3/4}	16	36	92	984
L3-36O	36 ^{7/16}	24	36	136	1,292
L4-36O	48 ^{1/8}	32	36	172	1,660
L5-36O	59 ^{13/16}	40	36	207	2,022
L6-36O	71 ^{1/2}	48	36	242	2,390
L1-42O	13 ^{1/16}	8	42	68	702

Legal Open Back, No Riser (cont.)

MODEL #	WIDTH	SLOTS	HEIGHT	WEIGHT	PRICE
L2-420	24 ³ / ₄	16	42	103	1,030
L3-420	36 ⁷ / ₁₆	24	42	153	1,356
L4-420	48 ¹ / ₈	32	42	191	1,743
L5-420	59 ¹³ / ₁₆	40	42	231	2,127
L6-420	71 ¹ / ₂	48	42	271	2,511
L1-480	13 ¹ / ₁₆	8	48	76	761
L2-480	24 ³ / ₄	16	48	114	943
L3-480	36 ⁷ / ₁₆	24	48	168	1,486
L4-480	48 ¹ / ₈	32	48	210	1,916
L5-480	59 ¹³ / ₁₆	40	48	242	2,333
L6-480	71 ¹ / ₂	48	48	300	2,757

Depth on all Legal-Size Sort Modules = 16⁷/₈"

Legal Open Back, 3" Riser



L4-30OE03

MODEL #	WIDTH	SLOTS	HEIGHT	WEIGHT	PRICE
L1-180E03	13 ¹ / ₁₆	6	21	43	446
L2-180E03	24 ³ / ₄	12	21	62	712
L3-180E03	36 ⁷ / ₁₆	18	21	90	910
L4-180E03	48 ¹ / ₈	24	21	112	1,169
L5-180E03	59 ¹³ / ₁₆	30	21	134	1,423
L6-180E03	71 ¹ / ₂	36	21	156	1,682
L1-240E03	13 ¹ / ₁₆	6	27	49	479
L2-240E03	24 ³ / ₄	12	27	72	764
L3-240E03	36 ⁷ / ₁₆	18	27	106	983
L4-240E03	48 ¹ / ₈	24	27	132	1,258
L5-240E03	59 ¹³ / ₁₆	30	27	158	1,537
L6-240E03	71 ¹ / ₂	36	27	185	1,813
L1-300E03	13 ¹ / ₁₆	6	33	56	546
L2-300E03	24 ³ / ₄	12	33	83	873
L3-300E03	36 ⁷ / ₁₆	18	33	122	1,126
L4-300E03	48 ¹ / ₈	24	33	150	1,443
L5-300E03	59 ¹³ / ₁₆	30	33	181	1,759
L6-300E03	71 ¹ / ₂	36	33	211	2,071
L1-360E03	13 ¹ / ₁₆	8	39	64	649
L2-360E03	24 ³ / ₄	16	39	95	984
L3-360E03	36 ⁷ / ₁₆	24	39	139	1,292
L4-360E03	48 ¹ / ₈	32	39	175	1,660
L5-360E03	59 ¹³ / ₁₆	40	39	210	2,022
L6-360E03	71 ¹ / ₂	48	39	245	2,390
L1-420E03	13 ¹ / ₁₆	8	45	71	702
L2-420E03	24 ³ / ₄	16	45	106	1,030
L3-420E03	36 ⁷ / ₁₆	24	45	156	1,356
L4-420E03	48 ¹ / ₈	32	45	194	1,743
L5-420E03	59 ¹³ / ₁₆	40	45	234	2,127
L6-420E03	71 ¹ / ₂	48	45	274	2,511

Depth on all Legal-Size Sort Modules = 16⁷/₈"

Open back risers are not available on open back modules.

Legal Open Back, 6" Riser



L4-30OE06

MODEL #	WIDTH	SLOTS	HEIGHT	WEIGHT	PRICE
L1-180E06	13 ¹ / ₁₆	6	24	45	557
L2-180E06	24 ³ / ₄	12	24	67	857
L3-180E06	36 ⁷ / ₁₆	18	24	97	1,057
L4-180E06	48 ¹ / ₈	24	24	120	1,243
L5-180E06	59 ¹³ / ₁₆	30	24	145	1,604
L6-180E06	71 ¹ / ₂	36	24	171	1,864
L1-240E06	13 ¹ / ₁₆	6	30	52	632
L2-240E06	24 ³ / ₄	12	30	77	977
L3-240E06	36 ⁷ / ₁₆	18	30	112	1,203
L4-240E06	48 ¹ / ₈	24	30	140	1,534
L5-240E06	59 ¹³ / ₁₆	30	30	169	1,834
L6-240E06	71 ¹ / ₂	36	30	200	2,139
L1-300E06	13 ¹ / ₁₆	6	36	58	689
L2-300E06	24 ³ / ₄	12	36	87	1,010
L3-300E06	36 ⁷ / ₁₆	18	36	128	1,264
L4-300E06	48 ¹ / ₈	24	36	158	1,614
L5-300E06	59 ¹³ / ₁₆	30	36	193	1,916
L6-300E06	71 ¹ / ₂	36	36	227	2,230
L1-360E06	13 ¹ / ₁₆	8	42	67	760
L2-360E06	24 ³ / ₄	16	42	100	1,139
L3-360E06	36 ⁷ / ₁₆	24	42	146	1,449
L4-360E06	48 ¹ / ₈	32	42	183	1,773
L5-360E06	59 ¹³ / ₁₆	40	42	221	2,125
L6-360E06	71 ¹ / ₂	48	42	261	2,464
L1-420E06	13 ¹ / ₁₆	8	48	76	869
L2-420E06	24 ³ / ₄	16	48	113	1,328
L3-420E06	36 ⁷ / ₁₆	24	48	166	1,708
L4-420E06	48 ¹ / ₈	32	48	207	2,125
L5-420E06	59 ¹³ / ₁₆	40	48	221	2,368
L6-420E06	71 ¹ / ₂	48	48	237	2,760

Depth on all Legal-Size Sort Modules = 16⁷/₈"

Open back risers are not available on open back modules.

Legal Open Back, 12" Riser



L4-24OE12

MODEL #	WIDTH	SLOTS	HEIGHT	WEIGHT	PRICE
L1-180E12	13 ¹ / ₁₆	6	30	52	630
L2-180E12	24 ³ / ₄	12	30	74	962
L3-180E12	36 ⁷ / ₁₆	18	30	107	1,177
L4-180E12	48 ¹ / ₈	24	30	131	1,317
L5-180E12	59 ¹³ / ₁₆	30	30	161	1,786
L6-180E12	71 ¹ / ₂	36	30	191	2,071
L1-240E12	13 ¹ / ₁₆	6	36	59	709
L2-240E12	24 ³ / ₄	12	36	85	1,001
L3-240E12	36 ⁷ / ₁₆	18	36	121	1,226
L4-240E12	48 ¹ / ₈	24	36	150	1,566
L5-240E12	59 ¹³ / ₁₆	30	36	184	1,868
L6-240E12	71 ¹ / ₂	36	36	218	2,175
L1-300E12	13 ¹ / ₁₆	6	42	65	726

Legal Open Back, 12" Riser (cont.)

MODEL #	WIDTH	SLOTS	HEIGHT	WEIGHT	PRICE
L2-30OE12	24 ^{3/4}	12	42	95	1,055
L3-30OE12	36 ^{7/16}	18	42	136	1,308
L4-30OE12	48 ^{1/8}	24	42	169	1,664
L5-30OE12	59 ^{13/16}	30	42	207	1,986
L6-30OE12	71 ^{1/2}	36	42	244	2,308
L1-36OE12	13 ^{1/16}	8	48	70	793
L2-36OE12	24 ^{3/4}	16	48	105	1,162
L3-36OE12	36 ^{7/16}	24	48	153	1,458
L4-36OE12	48 ^{1/8}	32	48	189	1,840
L5-36OE12	59 ^{13/16}	40	48	230	2,199
L6-36OE12	71 ^{1/2}	48	48	271	2,550

Depth on all Legal-Size Sort Modules = 16^{7/8}"
Open back risers are not available on open back modules.

Legal Open Back, 18" Riser

L4-30OE18

MODEL #	WIDTH	SLOTS	HEIGHT	WEIGHT	PRICE
L1-18OE18	13 ^{1/16}	6	36	57	739
L2-18OE18	24 ^{3/4}	12	36	81	966
L3-18OE18	36 ^{7/16}	18	36	117	1,182
L4-18OE18	48 ^{1/8}	24	36	142	1,506
L5-18OE18	59 ^{13/16}	30	36	176	1,833
L6-18OE18	71 ^{1/2}	36	36	209	2,070
L1-24OE18	13 ^{1/16}	6	42	64	759
L2-24OE18	24 ^{3/4}	12	42	91	1,019
L3-24OE18	36 ^{7/16}	18	42	131	1,256
L4-24OE18	48 ^{1/8}	24	42	161	1,600
L5-24OE18	59 ^{13/16}	30	42	198	1,905
L6-24OE18	71 ^{1/2}	36	42	237	2,208
L1-30OE18	13 ^{1/16}	6	48	70	816
L2-30OE18	24 ^{3/4}	12	48	101	1,127
L3-30OE18	36 ^{7/16}	18	48	145	1,392
L4-30OE18	48 ^{1/8}	24	48	180	1,775
L5-30OE18	59 ^{13/16}	30	48	221	2,117
L6-30OE18	71 ^{1/2}	36	48	263	2,459

Depth on all Legal-Size Sort Modules = 16^{7/8}"
Open back risers are not available on open back modules.

Legal Plexiglass Back, No Riser

L4-30P

MODEL #	WIDTH	SLOTS	HEIGHT	WEIGHT	PRICE
L1-18P	13 ^{1/16}	6	18	40	526
L2-18P	24 ^{3/4}	12	18	59	813
L3-18P	36 ^{7/16}	18	18	79	1,027
L4-18P	48 ^{1/8}	24	18	99	1,366
L5-18P	59 ^{13/16}	30	18	119	1,638
L6-18P	71 ^{1/2}	36	18	139	1,912
L1-24P	13 ^{1/16}	6	24	46	562
L2-24P	24 ^{3/4}	12	24	69	874
L3-24P	36 ^{7/16}	18	24	94	1,114

Legal Plexiglass Back, No Riser (cont.)

MODEL #	WIDTH	SLOTS	HEIGHT	WEIGHT	PRICE
L4-24P	48 ^{1/8}	24	24	117	1,478
L5-24P	59 ^{13/16}	30	24	141	1,777
L6-24P	71 ^{1/2}	36	24	165	2,078
L1-30P	13 ^{1/16}	6	30	53	635
L2-30P	24 ^{3/4}	12	30	80	995
L3-30P	36 ^{7/16}	18	30	108	1,276
L4-30P	48 ^{1/8}	24	30	134	1,684
L5-30P	59 ^{13/16}	30	30	162	2,027
L6-30P	71 ^{1/2}	36	30	189	2,372
L1-36P	13 ^{1/16}	8	36	61	775
L2-36P	24 ^{3/4}	16	36	92	1,115
L3-36P	36 ^{7/16}	24	36	124	1,457
L4-36P	48 ^{1/8}	32	36	156	1,923
L5-36P	59 ^{13/16}	40	36	188	2,324
L6-36P	71 ^{1/2}	48	36	220	2,724
L1-42P	13 ^{1/16}	8	42	68	807
L2-42P	24 ^{3/4}	16	42	103	1,172
L3-42P	36 ^{7/16}	24	42	139	1,539
L4-42P	48 ^{1/8}	32	42	174	2,031
L5-42P	59 ^{13/16}	40	42	210	2,457
L6-42P	71 ^{1/2}	48	42	246	2,879
L1-48P	13 ^{1/16}	8	48	76	870
L2-48P	24 ^{3/4}	16	48	114	1,281
L3-48P	36 ^{7/16}	24	48	153	1,691
L4-48P	48 ^{1/8}	32	48	191	2,226
L5-48P	59 ^{13/16}	40	48	232	2,696
L6-48P	71 ^{1/2}	48	48	273	3,161

Depth on all Legal-Size Sort Modules = 16^{7/8}"

Legal Plexiglass Back, 3" Riser

L4-30PE03

MODEL #	WIDTH	SLOTS	HEIGHT	WEIGHT	PRICE
L1-18PE03	13 ^{1/16}	6	21	43	526
L2-18PE03	24 ^{3/4}	12	21	62	813
L3-18PE03	36 ^{7/16}	18	21	82	1,027
L4-18PE03	48 ^{1/8}	24	21	102	1,366
L5-18PE03	59 ^{13/16}	30	21	122	1,638
L6-18PE03	71 ^{1/2}	36	21	142	1,916
L1-24PE03	13 ^{1/16}	6	27	49	562
L2-24PE03	24 ^{3/4}	12	27	72	874
L3-24PE03	36 ^{7/16}	18	27	97	1,114
L4-24PE03	48 ^{1/8}	24	27	120	1,478
L5-24PE03	59 ^{13/16}	30	27	144	1,779
L6-24PE03	71 ^{1/2}	36	27	168	2,078
L1-30PE03	13 ^{1/16}	6	33	56	635
L2-30PE03	24 ^{3/4}	12	33	83	995
L3-30PE03	36 ^{7/16}	18	33	111	1,276
L4-30PE03	48 ^{1/8}	24	33	137	1,688
L5-30PE03	59 ^{13/16}	30	33	165	2,028
L6-30PE03	71 ^{1/2}	36	33	192	2,370

Legal Plexiglass Back, 3" Riser (cont.)

MODEL #	WIDTH	SLOTS	HEIGHT	WEIGHT	PRICE
L1-36PE03	13 ¹ / ₁₆	8	39	64	775
L2-36PE03	24 ³ / ₄	16	39	95	1,115
L3-36PE03	36 ⁷ / ₁₆	24	39	127	1,457
L4-36PE03	48 ¹ / ₈	32	39	159	1,923
L5-36PE03	59 ¹³ / ₁₆	40	39	191	2,324
L6-36PE03	71 ¹ / ₂	48	39	223	2,725
L1-42PE03	13 ¹ / ₁₆	8	45	71	807
L2-42PE03	24 ³ / ₄	16	45	106	1,173
L3-42PE03	36 ⁷ / ₁₆	24	45	142	1,538
L4-42PE03	48 ¹ / ₈	32	45	177	2,031
L5-42PE03	59 ¹³ / ₁₆	40	45	213	2,457
L6-42PE03	71 ¹ / ₂	48	45	249	2,879

Depth on all Legal-Size Sort Modules = 16⁷/₈"
 For open riser, change model # to P (for pass-through)
 at no additional charge.

Legal Plexiglass Back, 6" Riser



L4-36PE06

MODEL #	WIDTH	SLOTS	HEIGHT	WEIGHT	PRICE
L1-18PE06	13 ¹ / ₁₆	6	24	45	636
L2-18PE06	24 ³ / ₄	12	24	67	956
L3-18PE06	36 ⁷ / ₁₆	18	24	88	1,172
L4-18PE06	48 ¹ / ₈	24	24	109	1,540
L5-18PE06	59 ¹³ / ₁₆	30	24	132	1,817
L6-18PE06	71 ¹ / ₂	36	24	155	2,094
L1-24PE06	13 ¹ / ₁₆	6	30	52	716
L2-24PE06	24 ³ / ₄	12	30	77	1,084
L3-24PE06	36 ⁷ / ₁₆	18	30	102	1,337
L4-24PE06	48 ¹ / ₈	24	30	127	1,754
L5-24PE06	59 ¹³ / ₁₆	30	30	154	2,077
L6-24PE06	71 ¹ / ₂	36	30	182	2,401
L1-30PE06	13 ¹ / ₁₆	6	36	58	780
L2-30PE06	24 ³ / ₄	12	36	87	1,132
L3-30PE06	36 ⁷ / ₁₆	18	36	116	1,416
L4-30PE06	48 ¹ / ₈	24	36	144	1,844
L5-30PE06	59 ¹³ / ₁₆	30	36	175	2,183
L6-30PE06	71 ¹ / ₂	36	36	206	2,528
L1-36PE06	13 ¹ / ₁₆	8	42	67	858
L2-36PE06	24 ³ / ₄	16	42	100	1,271
L3-36PE06	36 ⁷ / ₁₆	24	42	133	1,616
L4-36PE06	48 ¹ / ₈	32	42	166	2,039
L5-36PE06	59 ¹³ / ₁₆	40	42	201	2,514
L6-36PE06	71 ¹ / ₂	48	42	237	2,981
L1-42PE06	13 ¹ / ₁₆	8	48	76	978
L2-42PE06	24 ³ / ₄	16	48	113	1,469
L3-42PE06	36 ⁷ / ₁₆	24	48	151	1,896
L4-42PE06	48 ¹ / ₈	32	48	288	2,325
L5-42PE06	59 ¹³ / ₁₆	40	48	228	2,699
L6-42PE06	71 ¹ / ₂	48	48	267	3,068

Depth on all Legal-Size Sort Modules = 16⁷/₈"
 For open riser, change model # to P (for pass-through)
 at no additional charge.

Legal Plexiglass Back, 12" Riser



L4-30PE12

MODEL #	WIDTH	SLOTS	HEIGHT	WEIGHT	PRICE
L1-18PE12	13 ¹ / ₁₆	6	30	52	709
L2-18PE12	24 ³ / ₄	12	30	74	1,062
L3-18PE12	36 ⁷ / ₁₆	18	30	97	1,293
L4-18PE12	48 ¹ / ₈	24	30	119	1,696
L5-18PE12	59 ¹³ / ₁₆	30	30	146	1,999
L6-18PE12	71 ¹ / ₂	36	30	174	2,306
L1-24PE12	13 ¹ / ₁₆	6	36	59	797
L2-24PE12	24 ³ / ₄	12	36	85	1,110
L3-24PE12	36 ⁷ / ₁₆	18	36	110	1,361
L4-24PE12	48 ¹ / ₈	24	36	136	1,786
L5-24PE12	59 ¹³ / ₁₆	30	36	167	2,113
L6-24PE12	71 ¹ / ₂	36	36	198	2,439
L1-30PE12	13 ¹ / ₁₆	6	42	65	837
L2-30PE12	24 ³ / ₄	12	42	95	1,176
L3-30PE12	36 ⁷ / ₁₆	18	42	124	1,458
L4-30PE12	48 ¹ / ₈	24	42	154	1,905
L5-30PE12	59 ¹³ / ₁₆	30	42	188	2,254
L6-30PE12	71 ¹ / ₂	36	42	222	2,606
L1-36PE12	13 ¹ / ₁₆	8	48	70	893
L2-36PE12	24 ³ / ₄	16	48	105	1,294
L3-36PE12	36 ⁷ / ₁₆	24	48	139	1,626
L4-36PE12	48 ¹ / ₈	32	48	172	2,105
L5-36PE12	59 ¹³ / ₁₆	40	48	209	2,497
L6-36PE12	71 ¹ / ₂	48	48	246	2,888

Depth on all Legal-Size Sort Modules = 16⁷/₈"
 For open riser, change model # to P (for pass-through)
 at no additional charge.

Legal Plexiglass Back, 18" Riser



L4-30PE18

MODEL #	WIDTH	SLOTS	HEIGHT	WEIGHT	PRICE
L1-18PE18	13 ¹ / ₁₆	6	36	57	823
L2-18PE18	24 ³ / ₄	12	36	81	1,066
L3-18PE18	36 ⁷ / ₁₆	18	36	106	1,296
L4-18PE18	48 ¹ / ₈	24	36	129	1,700
L5-18PE18	59 ¹³ / ₁₆	30	36	160	1,999
L6-18PE18	71 ¹ / ₂	36	36	190	2,302
L1-24PE18	13 ¹ / ₁₆	6	42	72	843
L2-24PE18	24 ³ / ₄	12	42	91	1,132
L3-24PE18	36 ⁷ / ₁₆	18	42	111	1,387
L4-24PE18	48 ¹ / ₈	24	42	146	1,820
L5-24PE18	59 ¹³ / ₁₆	30	42	180	2,147
L6-24PE18	71 ¹ / ₂	36	42	215	2,477
L1-30PE18	13 ¹ / ₁₆	6	48	79	907
L2-30PE18	24 ³ / ₄	12	48	98	1,250
L3-30PE18	36 ⁷ / ₁₆	18	48	117	1,541
L4-30PE18	48 ¹ / ₈	24	48	164	2,017
L5-30PE18	59 ¹³ / ₁₆	30	48	201	2,390
L6-30PE18	71 ¹ / ₂	36	48	239	2,760

Depth on all Legal-Size Sort Modules = 16⁷/₈"
 For open riser, change model # to P (for pass-through)
 at no additional charge.

Oversize Closed Back, No Riser

O4-36C

MODEL #	WIDTH	SLOTS	HEIGHT	WEIGHT	PRICE
01-18C	15 ^{1/16}	6	18	42	455
02-18C	28 ^{3/4}	12	18	65	732
03-18C	42 ^{7/16}	18	18	97	954
04-18C	56 ^{1/8}	24	18	121	1,217
05-18C	69 ^{13/16}	30	18	146	1,499
06-18C	83 ^{1/2}	36	18	172	1,783
01-24C	15 ^{1/16}	6	24	50	483
02-24C	28 ^{3/4}	12	24	76	779
03-24C	42 ^{7/16}	18	24	112	1,027
04-24C	56 ^{1/8}	24	24	142	1,307
05-24C	69 ^{13/16}	30	24	172	1,621
06-24C	83 ^{1/2}	36	24	202	1,934
01-30C	15 ^{1/16}	6	30	56	557
02-30C	28 ^{3/4}	12	30	87	894
03-30C	42 ^{7/16}	18	30	130	1,177
04-30C	56 ^{1/8}	24	30	162	1,496
05-30C	69 ^{13/16}	30	30	196	1,844
06-30C	83 ^{1/2}	36	30	230	2,185
01-36C	15 ^{1/16}	8	36	64	678
02-36C	28 ^{3/4}	16	36	100	1,011
03-36C	42 ^{7/16}	24	36	150	1,349
04-36C	56 ^{1/8}	32	36	190	1,726
05-36C	69 ^{13/16}	40	36	229	2,127
06-36C	83 ^{1/2}	48	36	267	2,527
01-42C	15 ^{1/16}	8	42	72	701
02-42C	28 ^{3/4}	16	42	111	1,058
03-42C	42 ^{7/16}	24	42	166	1,418
04-42C	56 ^{1/8}	32	42	210	1,811
05-42C	69 ^{13/16}	40	42	254	2,232
06-42C	83 ^{1/2}	48	42	298	2,651
01-48C	15 ^{1/16}	8	48	99	761
02-48C	28 ^{3/4}	16	48	129	1,159
03-48C	42 ^{7/16}	24	48	182	1,556
04-48C	56 ^{1/8}	32	48	231	2,097
05-48C	69 ^{13/16}	40	48	279	2,450
06-48C	83 ^{1/2}	48	48	328	2,910

Depth on all Oversize Sort Modules = 16^{7/8}"**Oversize Closed Back, 3" Riser**

O4-30CE03

MODEL #	WIDTH	SLOTS	HEIGHT	WEIGHT	PRICE
01-18CE03	15 ^{1/16}	6	21	45	455
02-18CE03	28 ^{3/4}	12	21	68	732
03-18CE03	42 ^{7/16}	18	21	100	954
04-18CE03	56 ^{1/8}	24	21	124	1,217
05-18CE03	69 ^{13/16}	30	21	149	1,499
06-18CE03	83 ^{1/2}	36	21	175	1,783
01-24CE03	15 ^{1/16}	6	27	53	483
02-24CE03	28 ^{3/4}	12	27	79	779

Oversize Closed Back, 3" Riser (cont.)

MODEL #	WIDTH	SLOTS	HEIGHT	WEIGHT	PRICE
03-24CE03	42 ^{7/16}	18	27	115	1,027
04-24CE03	56 ^{1/8}	24	27	145	1,307
05-24CE03	69 ^{13/16}	30	27	175	1,621
06-24CE03	83 ^{1/2}	36	27	205	1,934
01-30CE03	15 ^{1/16}	6	33	59	557
02-30CE03	28 ^{3/4}	12	33	90	894
03-30CE03	42 ^{7/16}	18	33	133	1,177
04-30CE03	56 ^{1/8}	24	33	165	1,496
05-30CE03	69 ^{13/16}	30	33	199	1,844
06-30CE03	83 ^{1/2}	36	33	233	2,185
01-36CE03	15 ^{1/16}	8	39	67	678
02-36CE03	28 ^{3/4}	16	39	103	1,011
03-36CE03	42 ^{7/16}	24	39	153	1,349
04-36CE03	56 ^{1/8}	32	39	193	1,726
05-36CE03	69 ^{13/16}	40	39	232	2,127
06-36CE03	83 ^{1/2}	48	39	270	2,527
01-42CE03	15 ^{1/16}	8	45	75	701
02-42CE03	28 ^{3/4}	16	45	114	1,058
03-42CE03	42 ^{7/16}	24	45	169	1,418
04-42CE03	56 ^{1/8}	32	45	213	1,811
05-42CE03	69 ^{13/16}	40	45	257	2,232
06-42CE03	83 ^{1/2}	48	45	301	2,651

Depth on all Oversize Sort Modules = 16^{7/8}"

For open riser, change model # to P (for pass-through) at no additional charge.

Oversize Closed Back, 6" Riser

O4-30CE06

MODEL #	WIDTH	SLOTS	HEIGHT	WEIGHT	PRICE
01-18CE06	15 ^{1/16}	6	24	48	565
02-18CE06	28 ^{3/4}	12	24	73	807
03-18CE06	42 ^{7/16}	18	24	107	1,091
04-18CE06	56 ^{1/8}	24	24	135	1,387
05-18CE06	69 ^{13/16}	30	24	162	1,692
06-18CE06	83 ^{1/2}	36	24	189	1,994
01-24CE06	15 ^{1/16}	6	30	55	633
02-24CE06	28 ^{3/4}	12	30	84	983
03-24CE06	42 ^{7/16}	18	30	123	1,258
04-24CE06	56 ^{1/8}	24	30	156	1,586
05-24CE06	69 ^{13/16}	30	30	188	1,939
06-24CE06	83 ^{1/2}	36	30	219	2,290
01-30CE06	15 ^{1/16}	6	36	63	728
02-30CE06	28 ^{3/4}	12	36	95	1,020
03-30CE06	42 ^{7/16}	18	36	140	1,320
04-30CE06	56 ^{1/8}	24	36	177	1,650
05-30CE06	69 ^{13/16}	30	36	212	2,014
06-30CE06	83 ^{1/2}	36	36	246	2,372
01-36CE06	15 ^{1/16}	8	42	69	800
02-36CE06	28 ^{3/4}	16	42	108	1,159
03-36CE06	42 ^{7/16}	24	42	161	1,514

Oversize Closed Back, 6" Riser (cont.)

MODEL #	WIDTH	SLOTS	HEIGHT	WEIGHT	PRICE
O4-36CEo6	56 ¹ / ₈	32	42	204	1,907
O5-36CEo6	69 ¹³ / ₁₆	40	42	245	2,262
O6-36CEo6	83 ¹ / ₂	48	42	288	2,621
O1-42CEo6	15 ¹ / ₁₆	8	48	76	912
O2-42CEo6	28 ³ / ₄	16	48	121	1,356
O3-42CEo6	42 ⁷ / ₁₆	24	48	183	1,796
O4-42CEo6	56 ¹ / ₈	32	48	230	2,268
O5-42CEo6	69 ¹³ / ₁₆	40	48	245	2,638
O6-42CEo6	83 ¹ / ₂	48	48	262	3,006

Depth on all Oversize Sort Modules = 16⁷/₈"
 For open riser, change model # to P (for pass-through)
 at no additional charge.

Oversize Closed Back, 12" Riser



O4-30CE12

MODEL #	WIDTH	SLOTS	HEIGHT	WEIGHT	PRICE
O1-18CE12	15 ¹ / ₁₆	6	30	55	636
O2-18CE12	28 ³ / ₄	12	30	80	979
O3-18CE12	42 ⁷ / ₁₆	18	30	118	1,236
O4-18CE12	56 ¹ / ₈	24	30	150	1,554
O5-18CE12	69 ¹³ / ₁₆	30	30	179	1,884
O6-18CE12	83 ¹ / ₂	36	30	208	2,214
O1-24CE12	15 ¹ / ₁₆	6	36	62	736
O2-24CE12	28 ³ / ₄	12	36	91	1,010
O3-24CE12	42 ⁷ / ₁₆	18	36	133	1,290
O4-24CE12	56 ¹ / ₈	24	36	171	1,621
O5-24CE12	69 ¹³ / ₁₆	30	36	204	2,055
O6-24CE12	83 ¹ / ₂	36	36	237	2,330
O1-30CE12	15 ¹ / ₁₆	6	42	69	764
O2-30CE12	28 ³ / ₄	12	42	102	1,068
O3-30CE12	42 ⁷ / ₁₆	18	42	149	1,372
O4-30CE12	56 ¹ / ₈	24	42	191	1,717
O5-30CE12	69 ¹³ / ₁₆	30	42	229	2,086
O6-30CE12	83 ¹ / ₂	36	42	266	2,453
O1-36CE12	15 ¹ / ₁₆	8	48	77	835
O2-36CE12	28 ³ / ₄	16	48	113	1,182
O3-36CE12	42 ⁷ / ₁₆	24	48	165	1,524
O4-36CE12	56 ¹ / ₈	32	48	212	1,903
O5-36CE12	69 ¹³ / ₁₆	40	48	254	2,296
O6-36CE12	83 ¹ / ₂	48	48	297	2,696

Depth on all Oversize Sort Modules = 16⁷/₈"
 For open riser, change model # to P (for pass-through)
 at no additional charge.

Oversize Closed Back, 18" Riser



O4-24CE18

MODEL #	WIDTH	SLOTS	HEIGHT	WEIGHT	PRICE
O1-18CE18	15 ¹ / ₁₆	6	36	61	759
O2-18CE18	28 ³ / ₄	12	36	88	984
O3-18CE18	42 ⁷ / ₁₆	18	36	128	1,245
O4-18CE18	56 ¹ / ₈	24	36	165	1,557

Oversize Closed Back, 18" Riser (cont.)

MODEL #	WIDTH	SLOTS	HEIGHT	WEIGHT	PRICE
O5-18CE18	69 ¹³ / ₁₆	30	36	195	1,886
O6-18CE18	83 ¹ / ₂	36	36	226	2,218
O1-24CE18	15 ¹ / ₁₆	6	42	67	777
O2-24CE18	28 ³ / ₄	12	42	99	1,035
O3-24CE18	42 ⁷ / ₁₆	18	42	144	1,318
O4-24CE18	56 ¹ / ₈	24	42	185	1,651
O5-24CE18	69 ¹³ / ₁₆	30	42	220	2,014
O6-24CE18	83 ¹ / ₂	36	42	255	2,369
O1-30CE18	15 ¹ / ₁₆	6	48	74	835
O2-30CE18	28 ³ / ₄	12	48	110	1,139
O3-30CE18	42 ⁷ / ₁₆	18	48	161	1,458
O4-30CE18	56 ¹ / ₈	24	48	206	1,834
O5-30CE18	69 ¹³ / ₁₆	30	48	245	2,240
O6-30CE18	83 ¹ / ₂	36	48	286	2,644

Depth on all Oversize Sort Modules = 16⁷/₈"
 For open riser, change model # to P (for pass-through)
 at no additional charge.

Oversize Open Back, No Riser



O4-360

MODEL #	WIDTH	SLOTS	HEIGHT	WEIGHT	PRICE
O1-180	15 ¹ / ₁₆	6	18	42	455
O2-180	28 ³ / ₄	12	18	65	732
O3-180	42 ⁷ / ₁₆	18	18	97	954
O4-180	56 ¹ / ₈	24	18	121	1,217
O5-180	69 ¹³ / ₁₆	30	18	146	1,499
O6-180	83 ¹ / ₂	36	18	172	1,783
O1-240	15 ¹ / ₁₆	6	24	50	483
O2-240	28 ³ / ₄	12	24	76	779
O3-240	42 ⁷ / ₁₆	18	24	112	1,027
O4-240	56 ¹ / ₈	24	24	142	1,307
O5-240	69 ¹³ / ₁₆	30	24	172	1,621
O6-240	83 ¹ / ₂	36	24	202	1,934
O1-300	15 ¹ / ₁₆	6	30	56	557
O2-300	28 ³ / ₄	12	30	87	894
O3-300	42 ⁷ / ₁₆	18	30	130	1,177
O4-300	56 ¹ / ₈	24	30	162	1,496
O5-300	69 ¹³ / ₁₆	30	30	196	1,844
O6-300	83 ¹ / ₂	36	30	230	2,185
O1-360	15 ¹ / ₁₆	8	36	64	678
O2-360	28 ³ / ₄	16	36	100	1,011
O3-360	42 ⁷ / ₁₆	24	36	150	1,349
O4-360	56 ¹ / ₈	32	36	190	1,726
O5-360	69 ¹³ / ₁₆	40	36	229	2,127
O6-360	83 ¹ / ₂	48	36	267	2,527
O1-420	15 ¹ / ₁₆	8	42	72	701
O2-420	28 ³ / ₄	16	42	111	1,058
O3-420	42 ⁷ / ₁₆	24	42	166	1,418

Oversize Open Back, No Riser (cont.)

MODEL #	WIDTH	SLOTS	HEIGHT	WEIGHT	PRICE
04-420	56 ¹ / ₈	32	42	210	1,811
05-420	69 ¹³ / ₁₆	40	42	254	2,232
06-420	83 ¹ / ₂	48	42	298	2,651
01-480	15 ¹ / ₁₆	8	48	99	761
02-480	28 ³ / ₄	16	48	129	1,159
03-480	42 ⁷ / ₁₆	24	48	182	1,556
04-480	56 ¹ / ₈	32	48	231	2,097
05-480	69 ¹³ / ₁₆	40	48	279	2,450
06-480	83 ¹ / ₂	48	48	328	2,910

Depth on all Oversize Sort Modules = 16⁷/₈"
 For open riser, change model # to P (for pass-through)
 at no additional charge.

Oversize Open Back, 3" Riser

04-300E03

MODEL #	WIDTH	SLOTS	HEIGHT	WEIGHT	PRICE
01-180E03	15 ¹ / ₁₆	6	21	45	455
02-180E03	28 ³ / ₄	12	21	68	732
03-180E03	42 ⁷ / ₁₆	18	21	100	954
04-180E03	56 ¹ / ₈	24	21	124	1,217
05-180E03	69 ¹³ / ₁₆	30	21	149	1,499
06-180E03	83 ¹ / ₂	36	21	175	1,783
01-240E03	15 ¹ / ₁₆	6	27	53	483
02-240E03	28 ³ / ₄	12	27	79	779
03-240E03	42 ⁷ / ₁₆	18	27	115	1,027
04-240E03	56 ¹ / ₈	24	27	145	1,307
05-240E03	69 ¹³ / ₁₆	30	27	175	1,621
06-240E03	83 ¹ / ₂	36	27	205	1,934
01-300E03	15 ¹ / ₁₆	6	33	59	557
02-300E03	28 ³ / ₄	12	33	90	894
03-300E03	42 ⁷ / ₁₆	18	33	133	1,177
04-300E03	56 ¹ / ₈	24	33	165	1,496
05-300E03	69 ¹³ / ₁₆	30	33	199	1,844
06-300E03	83 ¹ / ₂	36	33	233	2,185
01-360E03	15 ¹ / ₁₆	8	39	67	678
02-360E03	28 ³ / ₄	16	39	103	1,011
03-360E03	42 ⁷ / ₁₆	24	39	153	1,349
04-360E03	56 ¹ / ₈	32	39	193	1,726
05-360E03	69 ¹³ / ₁₆	40	39	232	2,127
06-360E03	83 ¹ / ₂	48	39	270	2,527
01-420E03	15 ¹ / ₁₆	8	45	75	701
02-420E03	28 ³ / ₄	16	45	114	1,058
03-420E03	42 ⁷ / ₁₆	24	45	169	1,418
04-420E03	56 ¹ / ₈	32	45	213	1,811
05-420E03	69 ¹³ / ₁₆	40	45	257	2,232
06-420E03	83 ¹ / ₂	48	45	301	2,651

Depth on all Oversize Sort Modules = 16⁷/₈"
 For open riser, change model # to P (for pass-through)
 at no additional charge.

Oversize Open Back, 6" Riser

04-300E06

MODEL #	WIDTH	SLOTS	HEIGHT	WEIGHT	PRICE
01-180E06	15 ¹ / ₁₆	6	24	48	565
02-180E06	28 ³ / ₄	12	24	73	807
03-180E06	42 ⁷ / ₁₆	18	24	107	1,091
04-180E06	56 ¹ / ₈	24	24	135	1,387
05-180E06	69 ¹³ / ₁₆	30	24	162	1,692
06-180E06	83 ¹ / ₂	36	24	189	1,994
01-240E06	15 ¹ / ₁₆	6	30	55	633
02-240E06	28 ³ / ₄	12	30	84	983
03-240E06	42 ⁷ / ₁₆	18	30	123	1,258
04-240E06	56 ¹ / ₈	24	30	156	1,586
05-240E06	69 ¹³ / ₁₆	30	30	188	1,939
06-240E06	83 ¹ / ₂	36	30	219	2,290
01-300E06	15 ¹ / ₁₆	6	36	63	728
02-300E06	28 ³ / ₄	12	36	95	1,020
03-300E06	42 ⁷ / ₁₆	18	36	140	1,320
04-300E06	56 ¹ / ₈	24	36	177	1,650
05-300E06	69 ¹³ / ₁₆	30	36	212	2,014
06-300E06	83 ¹ / ₂	36	36	246	2,372
01-360E06	15 ¹ / ₁₆	8	42	69	800
02-360E06	28 ³ / ₄	16	42	108	1,159
03-360E06	42 ⁷ / ₁₆	24	42	161	1,514
04-360E06	56 ¹ / ₈	32	42	204	1,907
05-360E06	69 ¹³ / ₁₆	40	42	245	2,262
06-360E06	83 ¹ / ₂	48	42	288	2,621
01-420E06	15 ¹ / ₁₆	8	48	76	912
02-420E06	28 ³ / ₄	16	48	121	1,356
03-420E06	42 ⁷ / ₁₆	24	48	183	1,796
04-420E06	56 ¹ / ₈	32	48	230	2,268
05-420E06	69 ¹³ / ₁₆	40	48	245	2,638
06-420E06	83 ¹ / ₂	48	48	262	3,006

Depth on all Oversize Sort Modules = 16⁷/₈"
 For open riser, change model # to P (for pass-through)
 at no additional charge.

Oversize Open Back, 12" Riser



	MODEL #	WIDTH	SLOTS	HEIGHT	WEIGHT	PRICE
O4-30OE12	O1-18OE12	15 1/16	6	30	55	636
	O2-18OE12	28 3/4	12	30	80	979
	O3-18OE12	42 7/16	18	30	118	1,236
	O4-18OE12	56 1/8	24	30	150	1,554
	O5-18OE12	69 13/16	30	30	179	1,884
	O6-18OE12	83 1/2	36	30	208	2,214
	O1-24OE12	15 1/16	6	36	62	736
	O2-24OE12	28 3/4	12	36	91	1,010
	O3-24OE12	42 7/16	18	36	133	1,290
	O4-24OE12	56 1/8	24	36	171	1,621
	O5-24OE12	69 13/16	30	36	204	2,055
	O6-24OE12	83 1/2	36	36	237	2,330
	O1-30OE12	15 1/16	6	42	69	764
	O2-30OE12	28 3/4	12	42	102	1,068
	O3-30OE12	42 7/16	18	42	149	1,372
	O4-30OE12	56 1/8	24	42	191	1,717
	O5-30OE12	69 13/16	30	42	229	2,086
	O6-30OE12	83 1/2	36	42	266	2,453
	O1-36OE12	15 1/16	8	48	77	835
	O2-36OE12	28 3/4	16	48	113	1,182
O3-36OE12	42 7/16	24	48	165	1,524	
O4-36OE12	56 1/8	32	48	212	1,903	
O5-36OE12	69 13/16	40	48	254	2,296	
O6-36OE12	83 1/2	48	48	297	2,696	

Depth on all Oversize Sort Modules = 16 7/8"
 For open riser, change model # to P (for pass-through)
 at no additional charge.

Oversize Open Back, 18" Riser



	MODEL #	WIDTH	SLOTS	HEIGHT	WEIGHT	PRICE
O4-24OE18	O1-18OE18	15 1/16	6	36	61	759
	O2-18OE18	28 3/4	12	36	88	984
	O3-18OE18	42 7/16	18	36	128	1,245
	O4-18OE18	56 1/8	24	36	165	1,557
	O5-18OE18	69 13/16	30	36	195	1,886
	O6-18OE18	83 1/2	36	36	226	2,218
	O1-24OE18	15 1/16	6	42	67	777
	O2-24OE18	28 3/4	12	42	99	1,035
	O3-24OE18	42 7/16	18	42	144	1,318
	O4-24OE18	56 1/8	24	42	185	1,651
	O5-24OE18	69 13/16	30	42	220	2,014
	O6-24OE18	83 1/2	36	42	255	2,369
	O1-30OE18	15 1/16	6	48	74	835
	O2-30OE18	28 3/4	12	48	110	1,139
	O3-30OE18	42 7/16	18	48	161	1,458

Oversize Open Back, 18" Riser (cont.)

	MODEL #	WIDTH	SLOTS	HEIGHT	WEIGHT	PRICE
	O4-30OE18	56 1/8	24	48	206	1,834
	O5-30OE18	69 13/16	30	48	245	2,240
	O6-30OE18	83 1/2	36	48	286	2,644

Depth on all Oversize Sort Modules = 16 7/8"
 For open riser, change model # to P (for pass-through)
 at no additional charge.

Oversize Plexiglass Back, No Riser



O4-36P

	MODEL #	WIDTH	SLOTS	HEIGHT	WEIGHT	PRICE
O4-36P	O1-18P	15 1/16	6	18	42	537
	O2-18P	28 3/4	12	18	65	835
	O3-18P	42 7/16	18	18	88	1,080
	O4-18P	56 1/8	24	18	110	1,422
	O5-18P	69 13/16	30	18	133	1,727
	O6-18P	83 1/2	36	18	156	2,032
	O1-24P	15 1/16	6	24	50	574
	O2-24P	28 3/4	12	24	76	896
	O3-24P	42 7/16	18	24	102	1,171
	O4-24P	56 1/8	24	24	129	1,541
	O5-24P	69 13/16	30	24	156	1,884
	O6-24P	83 1/2	36	24	184	2,222
	O1-30P	15 1/16	6	30	56	656
	O2-30P	28 3/4	12	30	87	1,022
	O3-30P	42 7/16	18	30	118	1,339
	O4-30P	56 1/8	24	30	147	1,760
	O5-30P	69 13/16	30	30	178	2,141
	O6-30P	83 1/2	36	30	209	2,518
	O1-36P	15 1/16	8	36	64	779
	O2-36P	28 3/4	16	36	100	1,157
O3-36P	42 7/16	24	36	136	1,534	
O4-36P	56 1/8	32	36	173	2,016	
O5-36P	69 13/16	40	36	208	2,457	
O6-36P	83 1/2	48	36	243	2,897	
O1-42P	15 1/16	8	42	72	813	
O2-42P	28 3/4	16	42	111	1,218	
O3-42P	42 7/16	24	42	151	1,622	
O4-42P	56 1/8	32	42	191	2,127	
O5-42P	69 13/16	40	42	231	2,596	
O6-42P	83 1/2	48	42	271	3,063	
O1-48P	15 1/16	8	48	79	876	
O2-48P	28 3/4	16	48	122	1,330	
O3-48P	42 7/16	24	48	165	1,777	
O4-48P	56 1/8	32	48	210	2,330	
O5-48P	69 13/16	40	48	254	2,844	
O6-48P	83 1/2	48	48	298	3,363	

Depth on all Oversize Sort Modules = 16 7/8"

Oversize Plexiglass Back, 3" Riser



O4-36PE03

MODEL #	WIDTH	SLOTS	HEIGHT	WEIGHT	PRICE
O1-18PE03	15 1/16	6	21	45	537
O2-18PE03	28 3/4	12	21	68	835
O3-18PE03	42 7/16	18	21	91	1,082
O4-18PE0	56 1/8	24	21	113	1,422
O5-18PE03	69 13/16	30	21	136	1,729
O6-18PE03	83 1/2	36	21	159	2,032
O1-24PE03	15 1/16	6	27	53	574
O2-24PE03	28 3/4	12	27	79	896
O3-24PE03	42 7/16	18	27	105	1,172
O4-24PE03	56 1/8	24	27	132	1,541
O5-24PE03	69 13/16	30	27	159	1,884
O6-24PE03	83 1/2	36	27	187	2,222
O1-30PE03	15 1/16	6	33	59	656
O2-30PE03	28 3/4	12	33	90	1,022
O3-30PE03	42 7/16	18	33	121	1,339
O4-30PE03	56 1/8	24	33	150	1,760
O5-30PE03	69 13/16	30	33	181	2,141
O6-30PE03	83 1/2	36	33	212	2,519
O1-36PE03	15 1/16	8	39	67	779
O2-36PE03	28 3/4	16	39	103	1,157
O3-36PE03	42 7/16	24	39	139	1,534
O4-36PE03	56 1/8	32	39	176	2,016
O5-36PE03	69 13/16	40	39	211	2,457
O6-36PE03	83 1/2	48	39	246	2,897
O1-42PE03	15 1/16	8	45	75	813
O2-42PE03	28 3/4	16	45	114	1,218
O3-42PE03	42 7/16	24	45	154	1,622
O4-42PE03	56 1/8	32	45	194	2,127
O5-42PE03	69 13/16	40	45	234	2,596
O6-42PE03	83 1/2	48	45	274	3,063

Depth on all Oversize Sort Modules = 16 7/8"
For open riser, change model # to P (for pass-through) at no additional charge.

Oversize Plexiglass Back, 6" Riser



O4-30PE06

MODEL #	WIDTH	SLOTS	HEIGHT	WEIGHT	PRICE
O1-18PE06	15 1/16	6	24	48	648
O2-18PE06	28 3/4	12	24	73	977
O3-18PE06	42 7/16	18	24	97	1,219
O4-18PE06	56 1/8	24	24	123	1,593
O5-18PE06	69 13/16	30	24	147	1,920
O6-18PE06	83 1/2	36	24	172	2,241
O1-24PE06	15 1/16	6	30	55	725
O2-24PE06	28 3/4	12	30	84	1,097
O3-24PE06	42 7/16	18	30	112	1,401
O4-24PE06	56 1/8	24	30	142	1,820
O5-24PE06	69 13/16	30	30	171	2,200
O6-24PE06	83 1/2	36	30	199	2,576
O1-30PE06	15 1/16	6	36	63	827

Oversize Plexiglass Back, 6" Riser (cont.)

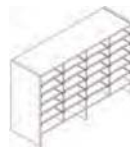

O4-30PE06

MODEL #	WIDTH	SLOTS	HEIGHT	WEIGHT	PRICE
O2-30PE06	28 3/4	12	36	95	1,153
O3-30PE06	42 7/16	18	36	127	1,486
O4-30PE06	56 1/8	24	36	161	1,916
O5-30PE06	69 13/16	30	36	193	2,310
O6-30PE06	83 1/2	36	36	224	2,700
O1-36PE06	15 1/16	8	42	69	904
O2-36PE06	28 3/4	16	42	108	1,304
O3-36PE06	42 7/16	24	42	146	1,700
O4-36PE06	56 1/8	32	42	285	2,199
O5-36PE06	69 13/16	40	42	223	2,595
O6-36PE06	83 1/2	48	42	262	2,990
O1-42PE06	15 1/16	8	48	76	1,022
O2-42PE06	28 3/4	16	48	121	1,512
O3-42PE06	42 7/16	24	48	166	1,999
O4-42PE06	56 1/8	32	48	209	2,584
O5-42PE06	69 13/16	40	48	254	3,002
O6-42PE06	83 1/2	48	48	299	3,417

Depth on all Oversize Sort Modules = 16 7/8"
For open riser, change model # to P (for pass-through) at no additional charge.

Oversize Plexiglass Back, 12" Riser



O4-24PE12

MODEL #	WIDTH	SLOTS	HEIGHT	WEIGHT	PRICE
O1-18PE12	15 1/16	6	30	55	725
O2-18PE12	28 3/4	12	30	80	1,080
O3-18PE12	42 7/16	18	30	107	1,363
O4-18PE12	56 1/8	24	30	136	1,760
O5-18PE12	69 13/16	30	30	163	2,113
O6-18PE12	83 1/2	36	30	189	2,460
O1-24PE12	15 1/16	6	36	62	825
O2-24PE12	28 3/4	12	36	91	1,127
O3-24PE12	42 7/16	18	36	121	1,435
O4-24PE12	56 1/8	24	36	155	1,855
O5-24PE12	69 13/16	30	36	185	2,239
O6-24PE12	83 1/2	36	36	215	2,620
O1-30PE12	15 1/16	6	42	69	865
O2-30PE12	28 3/4	12	42	102	1,199
O3-30PE12	42 7/16	18	42	135	1,539
O4-30PE12	56 1/8	24	42	174	1,980
O5-30PE12	69 13/16	30	42	208	2,381
O6-30PE12	83 1/2	36	42	242	2,779
O1-36PE12	15 1/16	8	48	77	939
O2-36PE12	28 3/4	16	48	113	1,328
O3-36PE12	42 7/16	24	48	150	1,708
O4-36PE12	56 1/8	32	48	193	2,191
O5-36PE12	69 13/16	40	48	231	2,625
O6-36PE12	83 1/2	48	48	270	3,063

Depth on all Oversize Sort Modules is 16 7/8"
For open riser, change model # to P (for pass-through) at no additional charge.

Oversize Plexiglass Back, 18" Riser



O4-30PE18

MODEL #	WIDTH	SLOTS	HEIGHT	WEIGHT	PRICE
O1-18PE18	15 ¹ / ₁₆	6	36	61	843
O2-18PE18	28 ³ / ₄	12	36	88	1,087
O3-18PE18	42 ⁷ / ₁₆	18	36	116	1,370
O4-18PE18	56 ¹ / ₈	24	36	150	1,763
O5-18PE18	69 ¹³ / ₁₆	30	36	177	2,115
O6-18PE18	83 ¹ / ₂	36	36	205	2,462
O1-24PE18	15 ¹ / ₁₆	6	42	77	868
O2-24PE18	28 ³ / ₄	12	42	99	1,152
O3-24PE18	42 ⁷ / ₁₆	18	42	121	1,465
O4-24PE18	56 ¹ / ₈	24	42	168	1,888
O5-24PE18	69 ¹³ / ₁₆	30	42	200	2,275
O6-24PE18	83 ¹ / ₂	36	42	232	2,658
O1-30PE18	15 ¹ / ₁₆	6	48	72	932
O2-30PE18	28 ³ / ₄	12	48	99	1,268
O3-30PE18	42 ⁷ / ₁₆	18	48	127	1,623
O4-30PE18	56 ¹ / ₈	24	48	187	2,095
O5-30PE18	69 ¹³ / ₁₆	30	48	223	2,536
O6-30PE18	83 ¹ / ₂	36	48	260	2,975

Depth on all Oversize Sort Modules is 16⁷/₈"
 For open riser, change model # to P (for pass-through)
 at no additional charge.

Zip Code Closed Back, No Platform



Z6-30C

MODEL #	WIDTH	SLOTS	HEIGHT	WEIGHT	PRICE
Z2-18C	15 ¹ / ₁₆	12	18	50	592
Z4-18C	28 ³ / ₄	24	18	80	995
Z6-18C	42 ⁷ / ₁₆	36	18	110	1,321
Z8-18C	56 ¹ / ₈	48	18	141	1,741
Z10-18C	69 ¹³ / ₁₆	60	18	171	2,162
Z12-18C	83 ¹ / ₂	72	18	200	2,578
Z2-24C	15 ¹ / ₁₆	12	24	59	639
Z4-24C	28 ³ / ₄	24	24	96	1,053
Z6-24C	42 ⁷ / ₁₆	36	24	132	1,466
Z8-24C	56 ¹ / ₈	48	24	168	1,896
Z10-24C	69 ¹³ / ₁₆	60	24	205	2,363
Z12-24C	83 ¹ / ₂	72	24	241	2,823
Z2-30C	15 ¹ / ₁₆	12	30	68	684
Z4-30C	28 ³ / ₄	24	30	111	1,153
Z6-30C	42 ⁷ / ₁₆	36	30	154	1,568
Z8-30C	56 ¹ / ₈	48	30	197	2,033
Z10-30C	69 ¹³ / ₁₆	60	30	239	2,521
Z12-30C	83 ¹ / ₂	72	30	281	3,006
Z2-36C	15 ¹ / ₁₆	16	36	79	755
Z4-36C	28 ³ / ₄	32	36	130	1,364

Zip Code Closed Back, No Platform (cont.)

MODEL #	WIDTH	SLOTS	HEIGHT	WEIGHT	PRICE
Z6-36C	42 ⁷ / ₁₆	48	36	180	1,974
Z8-36C	56 ¹ / ₈	64	36	231	2,441
Z10-36C	69 ¹³ / ₁₆	80	36	282	3,027
Z12-36C	83 ¹ / ₂	96	36	332	3,610
Z2-42C	15 ¹ / ₁₆	16	42	90	826
Z4-42C	28 ³ / ₄	32	42	149	1,575
Z6-42C	42 ⁷ / ₁₆	48	42	207	2,318
Z8-42C	56 ¹ / ₈	64	42	265	2,848
Z10-42C	69 ¹³ / ₁₆	80	42	325	3,532
Z12-42C	83 ¹ / ₂	96	42	384	4,215
Z2-48C	15 ¹ / ₁₆	16	48	101	896
Z4-48C	28 ³ / ₄	32	48	167	1,783
Z6-48C	42 ⁷ / ₁₆	48	48	233	2,713
Z8-48C	56 ¹ / ₈	64	48	299	3,178
Z10-48C	69 ¹³ / ₁₆	80	48	367	4,039
Z12-48C	83 ¹ / ₂	96	48	436	4,824

Depth on all Zip Code Sort Modules is 12⁷/₈"

Zip Code Closed Back, 3" Riser



Z4-30CE03

MODEL #	WIDTH	SLOTS	HEIGHT	WEIGHT	PRICE
Z2-18CE03	15 ¹ / ₁₆	12	21	53	592
Z4-18CE03	28 ³ / ₄	24	21	83	995
Z6-18CE03	42 ⁷ / ₁₆	36	21	113	1,321
Z8-18CE03	56 ¹ / ₈	48	21	144	1,741
Z10-18CE03	69 ¹³ / ₁₆	60	21	174	2,162
Z12-18CE03	83 ¹ / ₂	72	21	203	2,578
Z2-24CE03	15 ¹ / ₁₆	12	27	62	639
Z4-24CE03	28 ³ / ₄	24	27	99	1,053
Z6-24CE03	42 ⁷ / ₁₆	36	27	135	1,466
Z8-24CE03	56 ¹ / ₈	48	27	171	1,896
Z10-24CE03	69 ¹³ / ₁₆	60	27	208	2,363
Z12-24CE03	83 ¹ / ₂	72	27	244	2,823
Z2-30CE03	15 ¹ / ₁₆	12	33	71	684
Z4-30CE03	28 ³ / ₄	24	33	114	1,153
Z6-30CE03	42 ⁷ / ₁₆	36	33	157	1,568
Z8-30CE03	56 ¹ / ₈	48	33	200	2,033
Z10-30CE03	69 ¹³ / ₁₆	60	33	242	2,521
Z12-30CE03	83 ¹ / ₂	72	33	284	3,006
Z2-36CE03	15 ¹ / ₁₆	16	39	82	755
Z4-36CE03	28 ³ / ₄	32	39	133	1,364
Z6-36CE03	42 ⁷ / ₁₆	48	39	183	1,974
Z8-36CE03	56 ¹ / ₈	64	39	234	2,441

Zip Code Closed Back, 3" Riser (cont.)

MODEL #	WIDTH	SLOTS	HEIGHT	WEIGHT	PRICE
Z10-36CE03	69 ^{13/16}	80	39	285	3,027
Z12-36CE03	83 ^{1/2}	96	39	335	3,610
Z2-42CE03	15 ^{1/16}	16	45	93	826
Z4-42CE03	28 ^{3/4}	32	45	152	1,575
Z6-42CE03	42 ^{7/16}	48	45	210	2,318
Z8-42CE03	56 ^{1/8}	64	45	268	2,848
Z10-42CE03	69 ^{13/16}	80	45	328	3,532
Z12-42CE03	83 ^{1/2}	96	45	387	4,215

Depth on all Zip Code Sort Modules is 12^{7/8}"

For open riser, change model # to P (for pass-through) at no additional charge.

Zip Code Closed Back, 6" Riser

Z4-36CE06

MODEL #	WIDTH	SLOTS	HEIGHT	WEIGHT	PRICE
Z2-18CE06	15 ^{1/16}	12	24	56	675
Z4-18CE06	28 ^{3/4}	24	24	88	1,077
Z6-18CE06	42 ^{7/16}	36	24	120	1,410
Z8-18CE06	56 ^{1/8}	48	24	154	1,820
Z10-18CE06	69 ^{13/16}	60	24	185	2,232
Z12-18CE06	83 ^{1/2}	72	24	216	2,647
Z2-24CE06	15 ^{1/16}	12	30	65	716
Z4-24CE06	28 ^{3/4}	24	30	103	1,156
Z6-24CE06	42 ^{7/16}	36	30	142	1,520
Z8-24CE06	56 ^{1/8}	48	30	182	1,968
Z10-24CE06	69 ^{13/16}	60	30	219	2,421
Z12-24CE06	83 ^{1/2}	72	30	256	2,874
Z2-30CE06	15 ^{1/16}	12	36	75	763
Z4-30CE06	28 ^{3/4}	24	36	119	1,230
Z6-30CE06	42 ^{7/16}	36	36	163	1,622
Z8-30CE06	56 ^{1/8}	48	36	209	2,095
Z10-30CE06	69 ^{13/16}	60	36	253	2,575
Z12-30CE06	83 ^{1/2}	72	36	297	3,054
Z2-36CE06	15 ^{1/16}	16	42	85	936
Z4-36CE06	28 ^{3/4}	32	42	138	1,428
Z6-36CE06	42 ^{7/16}	48	42	190	1,919
Z8-36CE06	56 ^{1/8}	64	42	244	2,483
Z10-36CE06	69 ^{13/16}	80	42	296	3,005
Z12-36CE06	83 ^{1/2}	96	42	348	3,528
Z2-42CE06	15 ^{1/16}	16	48	95	1,110
Z4-42CE06	28 ^{3/4}	32	48	156	1,626
Z6-42CE06	42 ^{7/16}	48	48	218	2,223
Z8-42CE06	56 ^{1/8}	64	48	279	2,871
Z10-42CE06	69 ^{13/16}	80	48	339	3,436
Z12-42CE06	83 ^{1/2}	96	48	398	4,001

Depth on all Zip Code Sort Modules is 12^{7/8}"

For open riser, change model # to P (for pass-through) at no additional charge.

Zip Code Closed Back, 12" Riser

Z4-30CE12

MODEL #	WIDTH	SLOTS	HEIGHT	WEIGHT	PRICE
Z2-18CE12	15 ^{1/16}	12	30	63	740
Z4-18CE12	28 ^{3/4}	24	30	96	1,163
Z6-18CE12	42 ^{7/16}	36	30	129	1,528
Z8-18CE12	56 ^{1/8}	48	30	167	1,967
Z10-18CE12	69 ^{13/16}	60	30	200	2,403
Z12-18CE12	83 ^{1/2}	72	30	233	2,841
Z2-24CE12	15 ^{1/16}	12	36	72	864
Z4-24CE12	28 ^{3/4}	24	36	111	1,256
Z6-24CE12	42 ^{7/16}	36	36	151	1,646
Z8-24CE12	56 ^{1/8}	48	36	195	2,124
Z10-24CE12	69 ^{13/16}	60	36	234	2,609
Z12-24CE12	83 ^{1/2}	72	36	274	3,094
Z2-30CE12	15 ^{1/16}	12	42	80	831
Z4-30CE12	28 ^{3/4}	24	42	127	1,331
Z6-30CE12	42 ^{7/16}	36	42	173	1,751
Z8-30CE12	56 ^{1/8}	48	42	222	2,249
Z10-30CE12	69 ^{13/16}	60	42	268	2,767
Z12-30CE12	83 ^{1/2}	72	42	315	3,200
Z2-36CE12	15 ^{1/16}	16	48	89	1,011
Z4-36CE12	28 ^{3/4}	32	48	142	1,545
Z6-36CE12	42 ^{7/16}	48	48	195	2,075
Z8-36CE12	56 ^{1/8}	64	48	250	2,686
Z10-36CE12	69 ^{13/16}	80	48	303	3,250
Z12-36CE12	83 ^{1/2}	96	48	355	3,815

Depth on all Zip Code Sort Modules is 12^{7/8}"

For open riser, change model # to P (for pass-through) at no additional charge.

Zip Code Closed Back, 18" Riser

Z4-30CE18

MODEL #	WIDTH	SLOTS	HEIGHT	WEIGHT	PRICE
Z2-18CE18	15 ^{1/16}	12	36	68	816
Z4-18CE18	28 ^{3/4}	24	36	103	1,185
Z6-18CE18	42 ^{7/16}	36	36	139	1,557
Z8-18CE18	56 ^{1/8}	48	36	180	1,997
Z10-18CE18	69 ^{13/16}	60	36	215	2,445
Z12-18CE18	83 ^{1/2}	72	36	249	2,891
Z2-24CE18	15 ^{1/16}	12	42	54	881
Z4-24CE18	28 ^{3/4}	24	42	119	1,276
Z6-24CE18	42 ^{7/16}	36	42	160	1,671
Z8-24CE18	56 ^{1/8}	48	42	208	2,150
Z10-24CE18	69 ^{13/16}	60	42	249	2,640
Z12-24CE18	83 ^{1/2}	72	42	289	3,130
Z2-30CE18	15 ^{1/16}	12	48	88	945
Z4-30CE18	28 ^{3/4}	24	48	134	1,368
Z6-30CE18	42 ^{7/16}	36	48	180	1,792
Z8-30CE18	56 ^{1/8}	48	48	235	2,309
Z10-30CE18	69 ^{13/16}	60	48	283	2,840
Z12-30CE18	83 ^{1/2}	72	48	330	3,371

Depth on all Zip Code Sort Modules is 12^{7/8}"

For open riser, change model # to P (for pass-through) at no additional charge.

Standard Reader Station



MCS36L

MODEL #	OPENING*	HGT	WGT	PRICE
MCS36C	Centered	36	180	1,729
MCS36R	Right	36	180	1,729
MCS36L	Left	36	180	1,729
MCS42C	Centered	42	200	1,779
MCS42R	Right	42	200	1,779
MCS42L	Left	42	200	1,779
MCS48C	Centered	48	225	1,844
MCS48R	Right	48	225	1,844
MCS48L	Left	48	225	1,844

Depth on all Standard Reader Stations is 12⁷/₈". Width is 59¹³/₁₆".

Reader Stations include 14 sorting shelves and one binder shelf.

*Standard Reader Stations feature a 34⁷/₁₆" open area for computer monitors or supplies.

Oversize Reader Station



MCO36R

MODEL #	OPENING*	HGT	WGT	PRICE
MCO36C	Centered	36	229	1,992
MCO36R	Right	36	229	1,992
MCO36L	Left	36	229	1,992
MCO42C	Centered	42	250	2,063
MCO42R	Right	42	250	2,063
MCO42L	Left	42	250	2,063
MCO48C	Centered	48	275	2,128
MCO48R	Right	48	275	2,128
MCO48L	Left	48	275	2,128

Depth on all Oversize Reader Stations is 16⁷/₈". Width is 69¹³/₁₆".

Reader Stations include 14 sorting shelves and one binder shelf.

*Oversize Reader Stations feature a 40⁷/₁₆" open area for computer monitors or supplies.

Sort Module Accessories

Plexiglass Overhead Display Boards



DSPBRD-S2

MODEL #	DESCRIPTION	WGT	PRICE
DSPBRD-S1	12"h Display Board for S1/L1 Module	4	40
DSPBRD-S2	12"h Display Board for S2/L2 Module	8	75
DSPBRD-S3	12"h Display Board for S3/L3 Module	12	110
DSPBRD-S4	12"h Display Board for S4/L4 Module	16	145
DSPBRD-S5	12"h Display Board for S5/L5 Module	20	180
DSPBRD-S6	12"h Display Board for S6/L6 Module	24	215
DSPBRD-o1	12"h Display Board for O1/Z2 Module	5	46

Plexiglass Overhead Display Boards (con't.)

MODEL #	DESCRIPTION	WGT	PRICE
DSPBRD-02	12"h Display Board for O2/Z4 Module	10	88
DSPBRD-03	12"h Display Board for O3/Z6 Module	15	128
DSPBRD-04	12"h Display Board for O4/Z8 Module	20	168
DSPBRD-05	12"h Display Board for O5/Z10 Module	25	211
DSPBRD-06	12"h Display Board for O6/Z12 Module	30	254

Plexiglass Module Doors (3¹/₁₆ Depth)

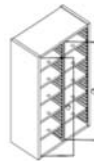

PLXS-30

Specify if for front or back of module

MODEL #	DESCRIPTION	FRONT WIDTH	BACK WIDTH	BACK HEIGHT	WGT	PRICE
18" High Door with 17¹/₁₆" Front Height						
PLXS-18	Standard/Legal	11 ¹ / ₄	10 ¹¹ / ₁₆	14 ⁷ / ₁₆	5	108
PLXS-18-L	Std/Legal w/Lock	11 ¹ / ₄	10 ¹¹ / ₁₆	14 ⁷ / ₁₆	5	141
PLXO-18	Oversize	13 ³ / ₄	12 ¹¹ / ₁₆	14 ⁷ / ₁₆	5	117
PLXO-18-L	Oversize w/Lock	13 ³ / ₄	12 ¹¹ / ₁₆	14 ⁷ / ₁₆	5	147
24" High Door with 23¹/₁₆" Front Height						
PLXS-24	Standard/Legal	11 ¹ / ₄	10 ¹¹ / ₁₆	20 ⁷ / ₁₆	6	123
PLXS-24-L	Std/Legal w/Lock	11 ¹ / ₄	10 ¹¹ / ₁₆	20 ⁷ / ₁₆	6	154
PLXO-24	Oversize	13 ³ / ₄	12 ¹¹ / ₁₆	20 ⁷ / ₁₆	6	129
PLXO-24-L	Oversize w/Lock	13 ³ / ₄	12 ¹¹ / ₁₆	20 ⁷ / ₁₆	6	147
30" High Door with 29¹/₁₆" Front Height						
PLXS-30	Standard/Legal	11 ¹ / ₄	10 ¹¹ / ₁₆	26 ⁷ / ₁₆	7	135
PLXS-30-L	Std/Legal w/Lock	11 ¹ / ₄	10 ¹¹ / ₁₆	26 ⁷ / ₁₆	7	163
PLXO-30	Oversize	13 ³ / ₄	12 ¹¹ / ₁₆	26 ⁷ / ₁₆	7	135
PLXO-30-L	Oversize w/Lock	13 ³ / ₄	12 ¹¹ / ₁₆	26 ⁷ / ₁₆	7	171
36" High Door with 35¹/₁₆" Front Height						
PLXS-36	Standard/Legal	11 ¹ / ₄	10 ¹¹ / ₁₆	32 ⁷ / ₁₆	8	114
PLXS-36-L	Std/Legal w/Lock	11 ¹ / ₄	10 ¹¹ / ₁₆	32 ⁷ / ₁₆	8	144
PLXO-36	Oversize	13 ³ / ₄	12 ¹¹ / ₁₆	32 ⁷ / ₁₆	8	119
PLXO-36-L	Oversize w/Lock	13 ³ / ₄	12 ¹¹ / ₁₆	32 ⁷ / ₁₆	8	151
42" High Door with 41¹/₁₆" Front Height						
PLXS-42	Standard/Legal	11 ¹ / ₄	10 ¹¹ / ₁₆	38 ⁷ / ₁₆	9	128
PLXS-42-L	Std/Legal w/Lock	11 ¹ / ₄	10 ¹¹ / ₁₆	38 ⁷ / ₁₆	9	160
PLXO-42	Oversize	13 ³ / ₄	12 ¹¹ / ₁₆	38 ⁷ / ₁₆	9	135
PLXO-42-L	Oversize w/Lock	13 ³ / ₄	12 ¹¹ / ₁₆	38 ⁷ / ₁₆	9	168
48" High Door with 47¹/₁₆" Front Height						
PLXS-48	Std/Legal	11 ¹ / ₄	10 ¹¹ / ₁₆	44 ⁷ / ₁₆	10	135
PLXS-48-L	Std/Legal w/Lock	11 ¹ / ₄	10 ¹¹ / ₁₆	44 ⁷ / ₁₆	10	168
PLXO-48	Oversize	13 ³ / ₄	12 ¹¹ / ₁₆	44 ⁷ / ₁₆	10	144
PLXO-48-L	Oversize w/Lock	13 ³ / ₄	12 ¹¹ / ₁₆	44 ⁷ / ₁₆	10	175

Guidelines for Specifying Corner Consoles & Modules

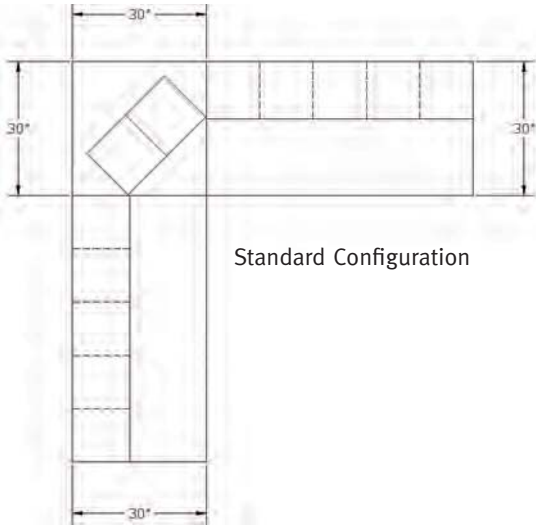

To get modules and consoles in the corners of 'L' or 'U' shaped configurations to line up, use the following guidelines:

Standard-Size Modules

- Use a 30" deep console on each side of the corner unit
- Use a 30" wide x 30" deep CT console for the corner unit
- Use a two-section, standard-size module for the corner unit

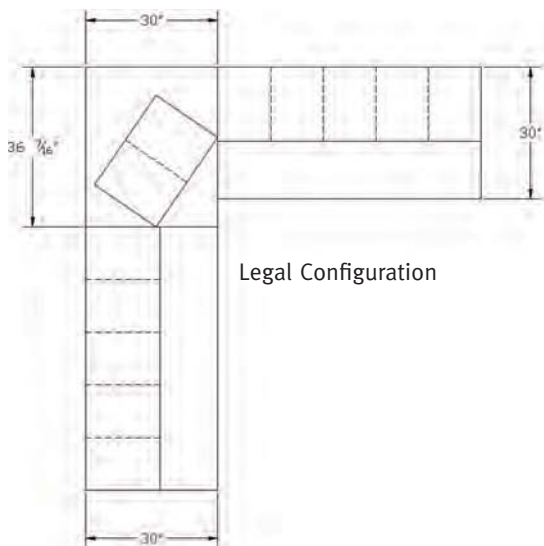

Legal-Size Modules

- Use a 30" deep console on each side of the corner unit
- Use a 36" wide x 30" deep CT console for the corner unit
- Use a two-section, legal-size module for the corner unit

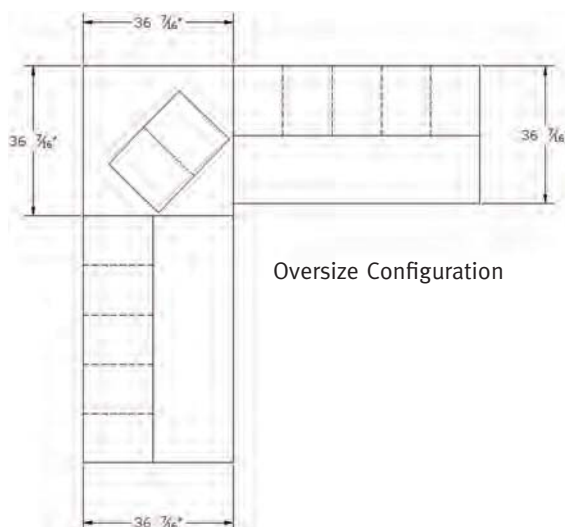

Oversize Modules

- Use a 36" deep console on each side of the corner unit
- Use a 36" wide x 36" deep console for the corner unit
- Use a two-section, oversize module for the corner unit

Freestanding Sort Modules

How to Specify Your Options

FSM481276SBSR

Sliding Doors

Model#	Increase	Description
D	\$174	With Doors
x	\$0	No doors

Handles*

Model	Increase	Description
EL	\$0	Elliptical
CB	\$0	Crescent Black
CS	\$0	Crescent Silver
TC	\$0	Textured Crescent
FC	\$0	Flared Crescent
WP	\$0	Wired Pull (MR Zinc)
SP	\$0	Special Handle

*Recessed handle is not an option

Slot Type
 S = Standard Size
 L = Legal Size
 O = Oversize

Doors

Handle

FSM 4 2 1 6 7 2 L B D Y C S

Sorting Width: 4
 Sorting Height: 2
 Bottom Storage Area: L
 Reference: B
 Sliding Reference: D
 Locks: Y
 Kickplate: S

Locks (on sliding doors)

Model#	Increase	Description
Y	\$38	Locks
x	\$0	No Locks

See page 60 for color codes.

Notes

1. Full-height Freestanding Sort Modules include 12 shelves per column, providing 13 openings per column. The sorting inches are equal to (height - 6") x # of columns.
2. Modules with Bottom Storage Area include 7 shelves per column, providing 8 openings per column. The sorting inches are equal to (height - 23") x # of columns. Modules with 12" Kickplate include 12 shelves per column, providing 13 openings per column. The sorting inches are equal to (height - 15") x # of columns.
3. Freestanding module with sliding reference shelves include 7 shelves per column, providing 8 openings per column. The sorting inches are equal to (height - 32") x # of columns.
4. Additional shelves can be ordered if more openings are required. Shelves can also be deleted if fewer openings are required.
5. Bottom storage areas will accommodate mail tubs.
6. Inside clearances on Bottom Storage Areas

Size	Depth	Height
Standard	12"	15"
Legal/Oversize	16"	15"
7. Sliding doors can be added to bottom storage areas, which reduces the depth clearance by 2 1/2".
8. Freestanding Sort Modules with Sliding Reference Shelves feature a bottom storage area and slide-out shelf located 30" off the ground.

Size	Shelf Pull Out Depth
Standard	9 3/4"
Legal/Oversize	13 3/4"
9. Reductions in the height of Freestanding Sort Modules can be made with an upcharge.
10. All Freestanding Sort Modules are shipped fully assembled. When getting freight quotes, specify Class 100. If dimensions are required, add 3" to each dimension for packing materials.

W/Bottom Storage w/o Sliding Shelf* (cont.)

MODEL #	SEC	W	D	HGT	SLOTS	WGT	PRICE
FSM561672OB	4	56 ⁷ / ₈	16 ⁷ / ₈	72	32	353	2,537
FSM561676OB	4	56 ⁷ / ₈	16 ⁷ / ₈	76	32	364	2,917

*For sliding doors on bottom storage add \$174. Lock is an additional \$38.

With Bottom Storage with Sliding Shelf*



FSM481276SBSR

MODEL #	SEC	W	D	HGT	SLOTS	WGT	PRICE
FSM361248SBSR	3	36 ⁷ / ₁₆	12 ⁷ / ₈	48	24	239	2,003
FSM361260SBSR	3	36 ⁷ / ₁₆	12 ⁷ / ₈	60	24	259	2,108
FSM361266SBSR	3	36 ⁷ / ₁₆	12 ⁷ / ₈	66	24	270	2,171
FSM361272SBSR	3	36 ⁷ / ₁₆	12 ⁷ / ₈	72	24	280	2,304
FSM361276SBSR	3	36 ⁷ / ₁₆	12 ⁷ / ₈	76	24	288	2,352
FSM481248SBSR	4	48 ¹ / ₈	12 ⁷ / ₈	48	32	277	2,330
FSM481260SBSR	4	48 ¹ / ₈	12 ⁷ / ₈	60	32	303	2,461
FSM481266SBSR	4	48 ¹ / ₈	12 ⁷ / ₈	66	32	316	2,542
FSM481272SBSR	4	48 ¹ / ₈	12 ⁷ / ₈	72	32	326	2,690
FSM481276SBSR	4	48 ¹ / ₈	12 ⁷ / ₈	76	32	335	2,979
FSM361648LBSR	3	36 ⁷ / ₁₆	16 ⁷ / ₈	48	24	263	2,168
FSM361660LBSR	3	36 ⁷ / ₁₆	16 ⁷ / ₈	60	24	289	2,326
FSM361666LBSR	3	36 ⁷ / ₁₆	16 ⁷ / ₈	66	24	301	2,356
FSM361672LBSR	3	36 ⁷ / ₁₆	16 ⁷ / ₈	72	24	314	2,571
FSM361676LBSR	3	36 ⁷ / ₁₆	16 ⁷ / ₈	76	24	328	2,778
FSM481648LBSR	4	48 ¹ / ₈	16 ⁷ / ₈	48	32	304	2,554
FSM481660LBSR	4	48 ¹ / ₈	16 ⁷ / ₈	60	32	336	2,750
FSM481666LBSR	4	48 ¹ / ₈	16 ⁷ / ₈	66	32	351	2,783
FSM481672LBSR	4	48 ¹ / ₈	16 ⁷ / ₈	72	32	367	3,020
FSM481676LBSR	4	48 ¹ / ₈	16 ⁷ / ₈	76	32	378	3,144
FSM421648OBSR	3	42 ⁷ / ₁₆	16 ⁷ / ₈	48	24	289	2,224
FSM421660OBSR	3	42 ⁷ / ₁₆	16 ⁷ / ₈	60	24	316	2,384
FSM421666OBSR	3	42 ⁷ / ₁₆	16 ⁷ / ₈	66	24	331	2,412
FSM421672OBSR	3	42 ⁷ / ₁₆	16 ⁷ / ₈	72	24	344	2,640
FSM421676OBSR	3	42 ⁷ / ₁₆	16 ⁷ / ₈	76	24	354	2,778
FSM561648OBSR	4	56 ⁷ / ₈	16 ⁷ / ₈	48	32	335	2,602
FSM561660OBSR	4	56 ⁷ / ₈	16 ⁷ / ₈	60	32	368	2,797
FSM561666OBSR	4	56 ⁷ / ₈	16 ⁷ / ₈	66	32	387	3,932
FSM561672OBSR	4	56 ⁷ / ₈	16 ⁷ / ₈	72	32	403	3,125
FSM561676OBSR	4	56 ⁷ / ₈	16 ⁷ / ₈	76	32	414	3,532

* Includes a sliding reference shelf above the bottom storage area.

For sliding doors on bottom storage add \$174. Lock is an additional \$38.

With 12" Kickplate*

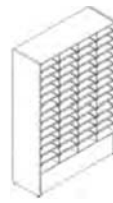

FSM481672LK

MODEL #	SEC	W	D	HGT	SLOTS	WGT	PRICE
FSM361248SK	3	36 ⁷ / ₁₆	12 ⁷ / ₈	48	39	186	1,537
FSM361260SK	3	36 ⁷ / ₁₆	12 ⁷ / ₈	60	39	207	1,636
FSM361266SK	3	36 ⁷ / ₁₆	12 ⁷ / ₈	66	39	217	1,694
FSM361272SK	3	36 ⁷ / ₁₆	12 ⁷ / ₈	72	39	228	1,814
FSM361276SK	3	36 ⁷ / ₁₆	12 ⁷ / ₈	76	39	234	1,862
FSM481248SK	4	48 ¹ / ₈	12 ⁷ / ₈	48	52	226	1,840
FSM481260SK	4	48 ¹ / ₈	12 ⁷ / ₈	60	52	252	2,076
FSM481266SK	4	48 ¹ / ₈	12 ⁷ / ₈	66	52	265	2,039
FSM481272SK	4	48 ¹ / ₈	12 ⁷ / ₈	72	52	273	2,178
FSM481276SK	4	48 ¹ / ₈	12 ⁷ / ₈	76	52	281	2,448
FSM361648LK	3	36 ⁷ / ₁₆	16 ⁷ / ₈	48	39	213	1,691
FSM361660LK	3	36 ⁷ / ₁₆	16 ⁷ / ₈	60	39	239	1,836
FSM361666LK	3	36 ⁷ / ₁₆	16 ⁷ / ₈	66	39	252	1,866
FSM361672LK	3	36 ⁷ / ₁₆	16 ⁷ / ₈	72	39	264	2,067
FSM361676LK	3	36 ⁷ / ₁₆	16 ⁷ / ₈	76	39	282	2,259
FSM481648LK	4	48 ¹ / ₈	16 ⁷ / ₈	48	52	253	2,050
FSM481660LK	4	48 ¹ / ₈	16 ⁷ / ₈	60	52	286	2,168
FSM481666LK	4	48 ¹ / ₈	16 ⁷ / ₈	66	52	301	2,201
FSM481672LK	4	48 ¹ / ₈	16 ⁷ / ₈	72	52	317	2,436
FSM481676LK	4	48 ¹ / ₈	16 ⁷ / ₈	76	52	327	2,665
FSM421648OK	3	42 ⁷ / ₁₆	16 ⁷ / ₈	48	39	238	1,743
FSM421660OK	3	42 ⁷ / ₁₆	16 ⁷ / ₈	60	39	266	1,890
FSM421666OK	3	42 ⁷ / ₁₆	16 ⁷ / ₈	66	39	279	1,919
FSM421672OK	3	42 ⁷ / ₁₆	16 ⁷ / ₈	72	39	294	2,128
FSM421676OK	3	42 ⁷ / ₁₆	16 ⁷ / ₈	76	39	304	2,259
FSM561648OK	4	56 ⁷ / ₈	16 ⁷ / ₈	48	52	277	2,096
FSM561660OK	4	56 ⁷ / ₈	16 ⁷ / ₈	60	52	317	2,279
FSM561666OK	4	56 ⁷ / ₈	16 ⁷ / ₈	66	52	334	2,316
FSM561672OK	4	56 ⁷ / ₈	16 ⁷ / ₈	72	52	352	2,583
FSM561676OK	4	56 ⁷ / ₈	16 ⁷ / ₈	76	52	363	2,961

All Wood Module Drawers

MODEL #	WIDTH	DEPTH	HEIGHT	WEIGHT	PRICE
MDSTD (Standard)	10 ³ / ₄	11 ³ / ₄	3 ¹ / ₂	5	75
MDLGL (Legal)	10 ³ / ₄	15 ³ / ₄	3 ¹ / ₂	7	75
MDOVR (Oversize)	12 ³ / ₄	15 ³ / ₄	3 ¹ / ₂	8	75

MDOVR

Accessories for Standard Module Shelves

MODEL #	DESCRIPTION	W	D	HGT	WGT	PRICE
RMS10	Single shelf	10 ³ / ₄	11 ³ / ₄		1	17
RMS10-5	Set of 5 shelves	10 ³ / ₄	11 ³ / ₄		3	69
WRMS10	Laminated wood shelf	10 ³ / ₄	11 ³ / ₄	5/8	2	32
XRMS10	Shelf deduct < standard amt				n/a	-16
INDX-S	10 Sheets of indexing				1	15
RMS10-V5	Set of 5 shelves w/vert. backs				4	86
RMS10HVD01	Shelf w/2 ¹ / ₂ "h half-size adapter					20
RMS10HVD03	Shelf w/4"h half-size adapter					21
CVR-SF	Plastic index cover for front of shelf	10 ³ / ₄			1	1
CVR-SB	Plastic index cover for back of shelf	10			1	1
STBCK-S	Stick-on indexing extrusion	10 ³ / ₄			1	2

Accessories for Legal Module Shelves

MODEL #	DESCRIPTION	W	D	HGT	WGT	PRICE
RMS14	Single shelf	10 ³ / ₄	15 ³ / ₄		1	17
RMS14-5	Set of 5 shelves	10 ³ / ₄	15 ³ / ₄		3	69
WRMS14	Laminated wood shelf	10 ³ / ₄	15 ³ / ₄	5/8	2	39
XRMS14	Shelf deduct < standard amt				n/a	-16
INDX-S	10 Sheets of indexing				1	15
RMS14-V5	Set of 5 shelves w/vert. backs				4	89
RMS14HVD01	Shelf w/2 ¹ / ₂ "h half-size adapter					21
RMS14HVD03	Shelf w/4"h half-size adapter					22
CVR-SF	Plastic index cover for front of shelf	10 ³ / ₄			1	1
CVR-SB	Plastic index cover for back of shelf	10			1	1
STBCK-S	Stick-on indexing extrusion	10 ³ / ₄			1	2

Accessories for Oversize Module Shelves

MODEL #	DESCRIPTION	W	D	HGT	WGT	PRICE
RMS12	Single shelf	12 ³ / ₄	15 ³ / ₄		1	17
RMS12-5	Set of 5 shelves	12 ³ / ₄	15 ³ / ₄		3	69
WRMS12	Laminated wood shelf	12 ³ / ₄	15 ³ / ₄	5/8	2	39
XRMS12	Shelf deduct < standard amt				n/a	-16
INDX-O	10 sheets of indexing				1	15
RMS12-V5	Set of 5 shelves w/vert. backs				4	91

Accessories for Oversize Module Shelves (cont.)

MODEL #	DESCRIPTION	W	D	HGT	WGT	PRICE
RMS12HVD01	Shelf w/2 ¹ / ₂ "h half-size adapter					22
RMS12HVD03	Shelf w/4"h half-size adapter					23
CVR-OF	Plastic index cover for front of shelf	12 ³ / ₄			1	1
CVR-OB	Plastic index cover for back of shelf	12			1	1
STBCK-O	Stick-on indexing extrusion	12 ³ / ₄			1	3

Accessories for Zip Size Module Shelves

MODEL #	DESCRIPTION	W	D	HGT	WGT	PRICE
RMSZ	Single shelf	6 ¹ / ₁₆	11 ³ / ₄		1	9
RMSZ-5	Set of 5 shelves	6 ¹ / ₁₆	11 ³ / ₄		3	66
XRMSZ	Shelf deduct < standard amt					-8

Accessories

MODEL #	DESCRIPTION	PRICE
MRUSTL-24	24" Black undersurface task light	140
MRUSTLARM	Swivel-arm task light	233
MRTBwwhh	Tackboard (per square foot)	24

MRUSTL-24

Accessories Notes

1. Shelf supports and shelves are available in four colors: clear, black, brown, and grey. Laminated wood shelves should be ordered in laminates with matching edge banding.
2. Shelves have full-width index channels on both the front and rear. The channel is encased with a clear plastic index cover.
3. Color-coded index strips are included with each module, one sheet (18 index strips) per column. If you want a specific color, you must request that color. If no specific color request is made, you will receive assorted colors.
4. Index strips are available in the following colors:

Green	Light Green
Magenta	Electric Yellow
Canary	Blue
Orange	White
Gold	Electric Pink
5. Indexing templates are available, at no charge, via our web site at www.hamiltonsorter.com under the Resources section. Contact Customer Service for more information.
6. These special shelves are also available:
 - Laminated wood shelves for additional weight capacity
 - Shelves with 3" vertical back for open-back modules
 - Shelves with half-size adapters for doubled sort openings.
7. Plexiglass doors are available in clear and smoked acrylic. If you are ordering an open-back sort module, specify whether the doors are going on the front or back of the unit. All doors are hinged on the left side and feature key or butterfly locks.
8. When plexiglass doors are placed on the front of a closed-back sort module, they restrict placement of shelves on the three upper, two middle, and three lower shelf supports. Doors must be removed to reposition shelves in these supports.
9. Specify location of all clear-acrylic display boards. Do not specify display boards for corner sort modules in L- or U-shaped configurations when display boards are specified for adjacent modules.
10. Tasklights and tackboards can be installed in the riser area of sort modules. Please specify fabric for tackboards.

Bulk Sort Units

With Flat Shelves*



SB551924

MODEL #	WIDTH	DEPTH	HEIGHT	WEIGHT	PRICE
One Shelf					
SB551924	56 ¹ / ₈	19	24	110	615
SB691924	69 ¹³ / ₁₆	19	24	130	668
Two Shelves					
SB551936	56 ¹ / ₈	19	36	160	819
SB691936	69 ¹³ / ₁₆	19	36	190	900
Three Shelves					
SB551948	56 ¹ / ₈	19	48	230	1,029
SB691948	69 ¹³ / ₁₆	19	48	270	1,131

With Angled Shelves*



AB482061

MODEL #	WIDTH	DEPTH	HEIGHT	WEIGHT	PRICE
One Shelf					
AB482021	48 ¹ / ₈	20	21	102	554
AB602021	59 ¹³ / ₁₆	20	21	122	595
Two Shelves					
AB482042	48 ¹ / ₈	20	42	177	785
AB602042	59 ¹³ / ₁₆	20	42	209	819
Three Shelves					
AB482061	48 ¹ / ₈	20	61	248	1,010
AB602061	59 ¹³ / ₁₆	20	61	272	1,097
Four Shelves					
AB482081	48 ¹ / ₈	20	81	320	1,238
AB602081	59 ¹³ / ₁₆	20	81	377	1,257

*1. All Desktop Bulk Sort Units have an aluminum-extrusion front edge.

2. Units with flat shelves have an inside clearance of 10¹³/₁₆.

3. Units with angled shelves have a 1"x1" aluminum stop on shelf front.

4. Shelves are angled at 25 degrees, will hold three or four mail tubs or AB35-200 bins per shelf (depending on model width), and have an inside clearance of 16³/₄ between angled shelves and a top shelf inside clearance of 12¹/₄.

5. Bins must be ordered separately.

6. All Bulk Sort Units are shipped fully assembled.

7. For freight quotes, specify Class 100 and if dimensions are required, add 3" to each dimension for packing materials.

8. Color choice for Bulk Sort laminate and edge banding should be specified individually.

9. Modification charge to reduce width is \$102 list.

Bulk Sort Bins



SB1219

MODEL #	WIDTH	DEPTH	HEIGHT	WEIGHT	PRICE
Bins for Bulk Sort Units with Flat Shelves					
SB1219	12 ³ / ₄	19	6	3	53
Bins for Bulk Sort Units with Angled Shelves*					
AB35-200	13 ¹ / ₂	19 ¹ / ₂	8	6	30
AB35-201	Lids for AB35-200				20
AB35-010	Label holder for AB35-200				21

All Purpose Bins

AB34-240	19	24 ¹ / ₂	9 ¹ / ₂	6	34
AB13-107	18 ⁷ / ₈	15 ¹ / ₄	12 ⁷ / ₁₆	5	29

1. SB1219 bins are constructed of molded plastic and have a full width index channel.

2. Index strips are included.

3. SB1219 bins will fit inside oversize sort modules, but must rest on shelf.

4. Angled shelf bulks sort bins are available in red, blue and grey.

5. To specify red or blue bins, add 'R' or 'B' to the end of the of the model number.

6. If no color is specified, bins will be grey.

7. Angled self bins nest together to take up minimal space when not in use.

8. AB34-240 bins are multi-purpose with rounded corners and rolled-top rims to form comfortable handles for easy carrying.

9. AB34-240 and AB13-017 bins are available in grey only.

10. AB13-017 bins stack to form tall storage arrangements.

11. Dimensions for other popular mail bins:

US Postal Tub 13¹/₂"w x 18" d x 13¹/₂"h

Us Postal Tray 13¹/₂"w x 25" d x 5" h

Masterseries Consoles

How to Specify Your Options

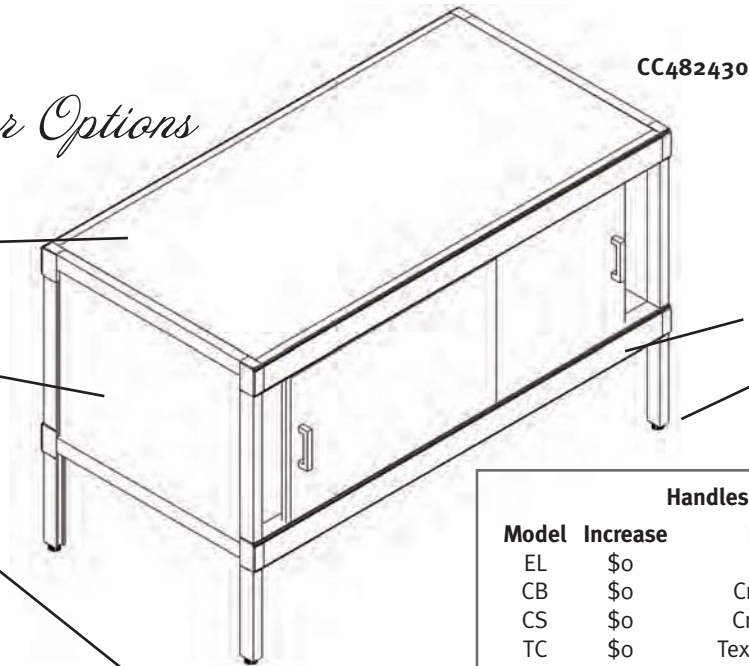

Model	Increase	Description
V+ Count	\$ 64	Yes
x	\$0	No

*Count would indicate number of partitions required

Handles [†]		
Model	Increase	Description
EL	\$0	Elliptical
CB	\$0	Crescent Black
CS	\$0	Crescent Silver
TC	\$0	Textured Crescent
FC	\$0	Flared Crescent
WP	\$0	Wired Pull (MR Zinc)
SP	\$0	Special Handle

[†]Recessed handle is not an option

Increase Per Square		
Model	Foot	Description
L	\$ 0	Laminate
A	\$20	ABS
S	\$46	Stainless Steel

- Console Type**
- CT = Basic Console
 - CH = Console w/Half-Depth Shelf
 - CS = Console w/Full-Depth Shelf
 - CC = Cabinet Console
 - CX = Centered Modesty

Accepts Wheels

W = Wheel
 x = No Wheel
 (for 9" clearance console only)

Wood Top Corner**

C = Wood Top
 x = No Wood Top

Undertable Vertical Partitions

Handle Options

Top Finish

CC603030LBWxx3V1YFC

Width

Height

Clearance Option
 B = 3" Clearance
 x = 9" Clearance

Dump Rim**
 3 = Three Sided (F or B)
 4 = Four Sided (F or B)
 x = None

Locks

Adjustable Legs

Locks		
Model	Increase	Description
x	\$ 0	No locks
Y	\$38	Locks

Model	Increase	Description
x	\$ 0	No Adjust
A	\$54	Adjustable Legs

See page 60 for color codes.

*Wood top corners do not have the dump rim option.

Notes

1. All consoles feature modesty panels located at the rear. The half shelf on CH consoles is also located at the rear.
2. All consoles 36" deep and 36" or wider have support bars mounted front-to-rear under the workstation.
3. Wheels can be added to fixed-height consoles with 9" floor clearance only. When adding wheels, add 'W' to the end of the model number to keep overall console height standard. Wheels must be ordered separately (see pg. 47).
4. Use CX consoles where 48" depth is required (see pg. 39).
5. Consoles 30" or 36" high with 9" clearances only can be fitted with adjustable legs. Order by adding 'A' to the end of the model number. Console height will adjust on 1/2" increments between 28"-32" on 30" high consoles and 34"-38" on 36" high consoles.
6. Adjustable consoles have a 12" range, from 28"h to 40"h.
7. Crank handles and electrical switches are located on the right-hand side of the consoles.
8. All adjustable consoles feature a 3" clearance.
9. Roller tables feature 22"w steel ball-bearing rollers mounted on 3" centers and a styrene top.

10. All consoles are shipped knocked down. When getting freight quotes, specify Class 85. If dimensions are required, use 10" for the height of the box and add 3" to the width and depth of the console.

11. Modifications to the width, depth, height of the console and the position of the modesty panel can be made.

12. Inside dimensions

MODEL	INSIDE WIDTH	MODEL DEPTH	HALF-SHELF DEPTH	FULL-SHELF DEPTH	MODEL HEIGHT	CAB HEIGHT 9" CLEAR	CAB HEIGHT 3" CLEAR
24	22 ³ / ₄	24	11 ⁷ / ₁₆	21 ⁷ / ₈	30	15 ⁷ / ₈	21 ⁷ / ₈
30	28	30	14 ¹ / ₁₆	27 ¹ / ₈	36	21 ⁷ / ₈	27 ⁷ / ₈
36	34 ⁷ / ₁₆	36	17 ¹⁵ / ₁₆	33 ⁹ / ₁₆	42	27 ⁷ / ₈	33 ⁹ / ₁₆
42	40 ⁷ / ₁₆						
48	46 ¹ / ₈						
55	54 ¹ / ₈						
60	57 ¹³ / ₁₆						
69	67 ¹³ / ₁₆						
72	69 ¹ / ₂						
84	81 ¹ / ₂						

Console Products

30" High with 9" Clearance



CT603030

MODEL #	WIDTH	DEPTH	WEIGHT	PRICE
CT242430	24 ³ / ₄	24 ³ / ₄	73	908
CT243030	24 ³ / ₄	30	80	954
CT243630	24 ³ / ₄	36 ⁷ / ₁₆	90	1,003
CT302430	30	24 ³ / ₄	78	948
CT303030	30	30	87	994
CT303630	30	36 ⁷ / ₁₆	97	1,040
CT362430	36 ⁷ / ₁₆	24 ³ / ₄	86	983
CT363030	36 ⁷ / ₁₆	30	95	1,033
CT363630	36 ⁷ / ₁₆	36 ⁷ / ₁₆	106	1,088
CT422430	42 ⁷ / ₁₆	24 ³ / ₄	92	1,007
CT423030	42 ⁷ / ₁₆	30	102	1,061
CT423630	42 ⁷ / ₁₆	36 ⁷ / ₁₆	114	1,116
CT482430	48 ¹ / ₈	24 ³ / ₄	99	1,040
CT483030	48 ¹ / ₈	30	110	1,097
CT483630	48 ¹ / ₈	36 ⁷ / ₁₆	122	1,262
CT552430	56 ¹ / ₈	24 ³ / ₄	109	1,094
CT553030	56 ¹ / ₈	30	120	1,220
CT553630	56 ¹ / ₈	36 ⁷ / ₁₆	133	1,298
CT602430	59 ¹³ / ₁₆	24 ³ / ₄	113	1,189
CT603030	59 ¹³ / ₁₆	30	124	1,265
CT603630	59 ¹³ / ₁₆	36 ⁷ / ₁₆	139	1,339
CT692430	69 ¹³ / ₁₆	24 ³ / ₄	136	1,308
CT693030	69 ¹³ / ₁₆	30	150	1,368
CT693630	69 ¹³ / ₁₆	36 ⁷ / ₁₆	167	1,448
CT722430	71 ¹ / ₂	24 ³ / ₄	142	1,371
CT723030	71 ¹ / ₂	30	155	1,439
CT723630	71 ¹ / ₂	36 ⁷ / ₁₆	172	1,512
CT842430	83 ¹ / ₂	24 ³ / ₄	164	1,622
CT843030	83 ¹ / ₂	30	179	1,678
CT843630	83 ¹ / ₂	36 ⁷ / ₁₆	197	1,758

30" High with 3" Clearance



CT723630B

MODEL #	WIDTH	DEPTH	WEIGHT	PRICE
CT242430B	24 ³ / ₄	24 ³ / ₄	78	956
CT243030B	24 ³ / ₄	30	86	1,001
CT243630B	24 ³ / ₄	36 ⁷ / ₁₆	96	1,046
CT302430B	30	24 ³ / ₄	84	1,004
CT303030B	30	30	92	1,053
CT303630B	30	36 ⁷ / ₁₆	102	1,097
CT362430B	36 ⁷ / ₁₆	24 ³ / ₄	91	1,055
CT363030B	36 ⁷ / ₁₆	30	100	1,098
CT363630B	36 ⁷ / ₁₆	36 ⁷ / ₁₆	111	1,157
CT422430B	42 ⁷ / ₁₆	24 ³ / ₄	98	1,088
CT423030B	42 ⁷ / ₁₆	30	108	1,141
CT423630B	42 ⁷ / ₁₆	36 ⁷ / ₁₆	120	1,197
CT482430B	48 ¹ / ₈	24 ³ / ₄	105	1,134

30" High with 3" Clearance (cont.)

MODEL #	WIDTH	DEPTH	WEIGHT	PRICE
CT483030B	48 ¹ / ₈	30	116	1,221
CT483630B	48 ¹ / ₈	36 ⁷ / ₁₆	128	1,356
CT552430B	56 ¹ / ₈	24 ³ / ₄	114	1,201
CT553030B	56 ¹ / ₈	30	125	1,326
CT553630B	56 ¹ / ₈	36 ⁷ / ₁₆	139	1,403
CT602430B	59 ¹³ / ₁₆	24 ³ / ₄	119	1,303
CT603030B	59 ¹³ / ₁₆	30	130	1,383
CT603630B	59 ¹³ / ₁₆	36 ⁷ / ₁₆	144	1,457
CT692430B	69 ¹³ / ₁₆	24 ³ / ₄	143	1,442
CT693030B	69 ¹³ / ₁₆	30	156	1,499
CT693630B	69 ¹³ / ₁₆	36 ⁷ / ₁₆	173	1,584
CT722430B	71 ¹ / ₂	24 ³ / ₄	147	1,511
CT723030B	71 ¹ / ₂	30	161	1,568
CT723630B	71 ¹ / ₂	36 ⁷ / ₁₆	178	1,650
CT842430B	83 ¹ / ₂	24 ³ / ₄	169	1,762
CT843030B	83 ¹ / ₂	30	185	1,811
CT843630B	83 ¹ / ₂	36 ⁷ / ₁₆	204	1,901

Options

MODIFICATION	MODEL # CHANGE	PRICE
Accepts wheels	CTwwdd 30W	None
Wood top corner	CTwwdd 30C	None
Adjustable legs	CTwwdd 30A	54

36" High with 9" Clearance*



CT422436

MODEL #	WIDTH	DEPTH	WEIGHT	PRICE
CT242436	24 ³ / ₄	24 ³ / ₄	81	937
CT243036	24 ³ / ₄	30	90	982
CT243636	24 ³ / ₄	36 ⁷ / ₁₆	101	1,033
CT302436	30	24 ³ / ₄	88	973
CT303036	30	30	97	1,019
CT303636	30	36 ⁷ / ₁₆	109	1,076
CT362436	36 ⁷ / ₁₆	24 ³ / ₄	96	1,010
CT363036	36 ⁷ / ₁₆	30	106	1,064
CT363636	36 ⁷ / ₁₆	36 ⁷ / ₁₆	118	1,122
CT422436	42 ⁷ / ₁₆	24 ³ / ₄	103	1,035
CT423036	42 ⁷ / ₁₆	30	113	1,086
CT423636	42 ⁷ / ₁₆	36 ⁷ / ₁₆	127	1,152
CT482436	48 ¹ / ₈	24 ³ / ₄	110	1,070
CT483036	48 ¹ / ₈	30	121	1,162
CT483636	48 ¹ / ₈	36 ⁷ / ₁₆	135	1,300
CT552436	56 ¹ / ₈	24 ³ / ₄	120	1,130
CT553036	56 ¹ / ₈	30	132	1,264
CT553636	56 ¹ / ₈	36 ⁷ / ₁₆	146	1,347
CT602436	59 ¹³ / ₁₆	24 ³ / ₄	124	1,236
CT603036	59 ¹³ / ₁₆	30	136	1,317
CT603636	59 ¹³ / ₁₆	36 ⁷ / ₁₆	152	1,373
CT692436	69 ¹³ / ₁₆	24 ³ / ₄	150	1,356

36" High with 9" Clearance* (cont.)

MODEL #	WIDTH	DEPTH	WEIGHT	PRICE
CT693036	69 ¹³ / ₁₆	30	165	1,419
CT693636	69 ¹³ / ₁₆	36 ⁷ / ₁₆	183	1,500
CT722436	71 ¹ / ₂	24 ³ / ₄	155	1,418
CT723036	71 ¹ / ₂	30	169	1,482
CT723636	71 ¹ / ₂	36 ⁷ / ₁₆	188	1,565
CT842436	83 ¹ / ₂	24 ³ / ₄	178	1,666
CT843036	83 ¹ / ₂	30	195	1,719
CT843636	83 ¹ / ₂	36 ⁷ / ₁₆	215	1,835

36" High with 3" Clearance

CT243636B

MODEL #	WIDTH	DEPTH	WEIGHT	PRICE
CT242436B	24 ³ / ₄	24 ³ / ₄	87	982
CT243036B	24 ³ / ₄	30	96	1,031
CT243636B	24 ³ / ₄	36 ⁷ / ₁₆	107	1,079
CT302436B	30	24 ³ / ₄	94	1,033
CT303036B	30	30	102	1,079
CT303636B	30	36 ⁷ / ₁₆	114	1,134
CT362436B	36 ⁷ / ₁₆	24 ³ / ₄	101	1,080
CT363036B	36 ⁷ / ₁₆	30	111	1,134
CT363636B	36 ⁷ / ₁₆	36 ⁷ / ₁₆	123	1,191
CT422436B	42 ⁷ / ₁₆	24 ³ / ₄	109	1,116
CT423036B	42 ⁷ / ₁₆	30	119	1,166
CT423636B	42 ⁷ / ₁₆	36 ⁷ / ₁₆	132	1,236
CT482436B	48 ¹ / ₈	24 ³ / ₄	116	1,164
CT483036B	48 ¹ / ₈	30	127	1,294
CT483636B	48 ¹ / ₈	36 ⁷ / ₁₆	141	1,391
CT552436B	56 ¹ / ₈	24 ³ / ₄	125	1,236
CT553036B	56 ¹ / ₈	30	138	1,372
CT553636B	56 ¹ / ₈	36 ⁷ / ₁₆	152	1,454
CT602436B	59 ¹³ / ₁₆	24 ³ / ₄	130	1,353
CT603036B	59 ¹³ / ₁₆	30	142	1,437
CT603636B	59 ¹³ / ₁₆	36 ⁷ / ₁₆	157	1,490
CT692436B	69 ¹³ / ₁₆	24 ³ / ₄	156	1,487
CT693036B	69 ¹³ / ₁₆	30	171	1,551
CT693636B	69 ¹³ / ₁₆	36 ⁷ / ₁₆	189	1,638
CT722436B	71 ¹ / ₂	24 ³ / ₄	161	1,556
CT723036B	71 ¹ / ₂	30	176	1,728
CT723636B	71 ¹ / ₂	36 ⁷ / ₁₆	194	1,704
CT842436B	83 ¹ / ₂	24 ³ / ₄	184	1,806
CT843036B	83 ¹ / ₂	30	201	1,856
CT843636B	83 ¹ / ₂	36 ⁷ / ₁₆	220	1,973

Options

MODIFICATION	MODEL # CHANGE	PRICE
Accepts wheels	CTwwdd 36W	None
Wood top corner	CTwwdd 30C	None
Adjustable legs	CTwwdd 36A	54
42" height	CTwwdd 42	153

30" High Half-Shelf with 9" Clearance

CH603030

MODEL #	WIDTH	DEPTH	WEIGHT	PRICE
CH242430	24 ³ / ₄	24 ³ / ₄	79	1,038
CH243030	24 ³ / ₄	30	88	1,088
CH243630	24 ³ / ₄	36 ⁷ / ₁₆	99	1,148
CH302430	30	24 ³ / ₄	86	1,092
CH303030	30	30	96	1,140
CH303630	30	36 ⁷ / ₁₆	108	1,210
CH362430	36 ⁷ / ₁₆	24 ³ / ₄	96	1,147
CH363030	36 ⁷ / ₁₆	30	107	1,198
CH363630	36 ⁷ / ₁₆	36 ⁷ / ₁₆	119	1,273
CH422430	42 ⁷ / ₁₆	24 ³ / ₄	105	1,193
CH423030	42 ⁷ / ₁₆	30	116	1,246
CH423630	42 ⁷ / ₁₆	36 ⁷ / ₁₆	130	1,325
CH482430	48 ¹ / ₈	24 ³ / ₄	112	1,238
CH483030	48 ¹ / ₈	30	124	1,298
CH483630	48 ¹ / ₈	36 ⁷ / ₁₆	140	1,376
CH552430	56 ¹ / ₈	24 ³ / ₄	124	1,339
CH553030	56 ¹ / ₈	30	138	1,376
CH553630	56 ¹ / ₈	36 ⁷ / ₁₆	154	1,465
CH602430	59 ¹³ / ₁₆	24 ³ / ₄	130	1,425
CH603030	59 ¹³ / ₁₆	30	143	1,512
CH603630	59 ¹³ / ₁₆	36 ⁷ / ₁₆	161	1,595
CH692430	69 ¹³ / ₁₆	24 ³ / ₄	158	1,565
CH693030	69 ¹³ / ₁₆	30	174	1,634
CH693630	69 ¹³ / ₁₆	36 ⁷ / ₁₆	195	1,743
CH722430	71 ¹ / ₂	24 ³ / ₄	164	1,586
CH723030	71 ¹ / ₂	30	180	1,662
CH723630	71 ¹ / ₂	36 ⁷ / ₁₆	201	1,763
CH842430	83 ¹ / ₂	24 ³ / ₄	190	1,821
CH843030	83 ¹ / ₂	30	209	1,894
CH843630	83 ¹ / ₂	36 ⁷ / ₁₆	232	2,019

30" High Half-Shelf with 3" Clearance*

CH722430B

MODEL #	WIDTH	DEPTH	WEIGHT	PRICE
CH242430B	24 ³ / ₄	24 ³ / ₄	85	1,132
CH243030B	24 ³ / ₄	30	94	1,196
CH243630B	24 ³ / ₄	36 ⁷ / ₁₆	105	1,257
CH302430B	30	24 ³ / ₄	91	1,148
CH303030B	30	30	101	1,197
CH303630B	30	36 ⁷ / ₁₆	113	1,271
CH362430B	36 ⁷ / ₁₆	24 ³ / ₄	101	1,217
CH363030B	36 ⁷ / ₁₆	30	112	1,271
CH363630B	36 ⁷ / ₁₆	36 ⁷ / ₁₆	124	1,339
CH422430B	42 ⁷ / ₁₆	24 ³ / ₄	110	1,273
CH423030B	42 ⁷ / ₁₆	30	121	1,325
CH423630B	42 ⁷ / ₁₆	36 ⁷ / ₁₆	135	1,404
CH482430B	48 ¹ / ₈	24 ³ / ₄	118	1,332
CH483030B	48 ¹ / ₈	30	130	1,387
CH483630B	48 ¹ / ₈	36 ⁷ / ₁₆	145	1,471

30" High Half-Shelf with 3" Clearance* (cont.)

MODEL #	WIDTH	DEPTH	WEIGHT	PRICE
CH552430B	56 ¹ / ₈	24 ³ / ₄	130	1,445
CH553030B	56 ¹ / ₈	30	143	1,483
CH553630B	56 ¹ / ₈	36 ⁷ / ₁₆	161	1,567
CH602430B	59 ¹³ / ₁₆	24 ³ / ₄	135	1,541
CH603030B	59 ¹³ / ₁₆	30	149	1,626
CH603630B	59 ¹³ / ₁₆	36 ⁷ / ₁₆	166	1,712
CH692430B	69 ¹³ / ₁₆	24 ³ / ₄	165	1,696
CH693030B	69 ¹³ / ₁₆	30	180	1,764
CH693630B	69 ¹³ / ₁₆	36 ⁷ / ₁₆	201	1,874
CH722430B	71 ¹ / ₂	24 ³ / ₄	169	1,723
CH723030B	71 ¹ / ₂	30	186	1,797
CH723630B	71 ¹ / ₂	36 ⁷ / ₁₆	207	1,903
CH842430B	83 ¹ / ₂	24 ³ / ₄	196	1,959
CH843030B	83 ¹ / ₂	30	216	2,032
CH843630B	83 ¹ / ₂	36 ⁷ / ₁₆	239	2,156

Options

MODIFICATION	MODEL # CHANGE	PRICE
Accepts wheels	CHwwdd30W	None
Adjustable legs 42" height	CHwwdd30A CHwwdd42	54 153

36" High Half-Shelf with 9" Clearance*



CH363036

MODEL #	WIDTH	DEPTH	WEIGHT	PRICE
CH242436	24 ³ / ₄	24 ³ / ₄	88	1,014
CH243036	24 ³ / ₄	30	98	1,087
CH243636	24 ³ / ₄	36 ⁷ / ₁₆	110	1,110
CH302436	30	24 ³ / ₄	96	1,066
CH303036	30	30	107	1,140
CH303636	30	36 ⁷ / ₁₆	120	1,169
CH362436	36 ⁷ / ₁₆	24 ³ / ₄	106	1,118
CH363036	36 ⁷ / ₁₆	30	117	1,196
CH363636	36 ⁷ / ₁₆	36 ⁷ / ₁₆	131	1,226
CH422436	42 ⁷ / ₁₆	24 ³ / ₄	114	1,162
CH423036	42 ⁷ / ₁₆	30	127	1,243
CH423636	42 ⁷ / ₁₆	36 ⁷ / ₁₆	142	1,278
CH482436	48 ¹ / ₈	24 ³ / ₄	123	1,209
CH483036	48 ¹ / ₈	30	136	1,292
CH483636	48 ¹ / ₈	36 ⁷ / ₁₆	153	1,369
CH552436	56 ¹ / ₈	4 ³ / ₄	135	1,283
CH553036	56 ¹ / ₈	30	150	1,371
CH553636	56 ¹ / ₈	36 ⁷ / ₁₆	167	1,414
CH602436	59 ¹³ / ₁₆	24 ³ / ₄	141	1,403
CH603036	59 ¹³ / ₁₆	30	155	1,507
CH603636	59 ¹³ / ₁₆	36 ⁷ / ₁₆	174	1,545
CH692436	69 ¹³ / ₁₆	24 ³ / ₄	172	1,520
CH693036	69 ¹³ / ₁₆	30	189	1,620
CH693636	69 ¹³ / ₁₆	36 ⁷ / ₁₆	210	1,694

36" High Half-Shelf with 9" Clearance* (cont.)

MODEL #	WIDTH	DEPTH	WEIGHT	PRICE
CH722436	71 ¹ / ₂	24 ³ / ₄	177	1,537
CH723036	71 ¹ / ₂	30	195	1,645
CH723636	71 ¹ / ₂	36 ⁷ / ₁₆	218	1,708
CH842436	83 ¹ / ₂	24 ³ / ₄	205	1,750
CH843036	83 ¹ / ₂	30	228	1,873
CH843636	83 ¹ / ₂	36 ⁷ / ₁₆	250	1,955

36" High Half-Shelf with 3" Clearance



CH483036B

MODEL #	WIDTH	DEPTH	WEIGHT	PRICE
CH242436B	24 ³ / ₄	24 ³ / ₄	94	1,111
CH243036B	24 ³ / ₄	30	103	1,189
CH243636B	24 ³ / ₄	36 ⁷ / ₁₆	116	1,213
CH302436B	30	24 ³ / ₄	101	1,174
CH303036B	30	30	112	1,255
CH303636B	30	36 ⁷ / ₁₆	125	1,284
CH362436B	36 ⁷ / ₁₆	24 ³ / ₄	111	1,246
CH363036B	36 ⁷ / ₁₆	30	122	1,322
CH363636B	36 ⁷ / ₁₆	36 ⁷ / ₁₆	136	1,358
CH422436B	42 ⁷ / ₁₆	24 ³ / ₄	120	1,303
CH423036B	42 ⁷ / ₁₆	30	132	1,385
CH423636B	42 ⁷ / ₁₆	36 ⁷ / ₁₆	147	1,421
CH482436B	48 ¹ / ₈	24 ³ / ₄	129	1,359
CH483036B	48 ¹ / ₈	30	142	1,447
CH483636B	48 ¹ / ₈	36 ⁷ / ₁₆	158	1,527
CH552436B	56 ¹ / ₈	4 ³ / ₄	141	1,453
CH553036B	56 ¹ / ₈	30	155	1,545
CH553636B	56 ¹ / ₈	36 ⁷ / ₁₆	174	1,591
CH602436B	59 ¹³ / ₁₆	24 ³ / ₄	146	1,581
CH603036B	59 ¹³ / ₁₆	30	161	1,695
CH603636B	59 ¹³ / ₁₆	36 ⁷ / ₁₆	179	1,737
CH692436B	69 ¹³ / ₁₆	24 ³ / ₄	178	1,726
CH693036B	69 ¹³ / ₁₆	30	195	1,836
CH693636B	69 ¹³ / ₁₆	36 ⁷ / ₁₆	217	1,910
CH722436B	71 ¹ / ₂	24 ³ / ₄	183	1,752
CH723036B	71 ¹ / ₂	30	201	1,864
CH723636B	71 ¹ / ₂	36 ⁷ / ₁₆	224	1,930
CH842436B	83 ¹ / ₂	24 ³ / ₄	210	1,972
CH843036B	83 ¹ / ₂	30	231	2,101
CH843636B	83 ¹ / ₂	36 ⁷ / ₁₆	255	2,193

Options

MODIFICATION	MODEL # CHANGE	PRICE
Accepts wheels	CHwwdd36W	None
Adjustable legs 42" height	CHwwdd36A CHwwdd42	54 153

30" High Full-Shelf with 9" Clearance

CS423630

MODEL #	WIDTH	DEPTH	WEIGHT	PRICE
CS242430	24 ³ / ₄	24 ³ / ₄	79	1,042
CS243030	24 ³ / ₄	30	88	1,093
CS243630	24 ³ / ₄	36 ⁷ / ₁₆	99	1,164
CS302430	30	24 ³ / ₄	86	1,098
CS303030	30	30	96	1,152
CS303630	30	36 ⁷ / ₁₆	108	1,224
CS362430	36 ⁷ / ₁₆	24 ³ / ₄	96	1,159
CS363030	36 ⁷ / ₁₆	30	107	1,214
CS363630	36 ⁷ / ₁₆	36 ⁷ / ₁₆	119	1,292
CS422430	42 ⁷ / ₁₆	24 ³ / ₄	105	1,205
CS423030	42 ⁷ / ₁₆	30	116	1,261
CS423630	42 ⁷ / ₁₆	36 ⁷ / ₁₆	130	1,347
CS482430	48 ¹ / ₈	24 ³ / ₄	112	1,255
CS483030	48 ¹ / ₈	30	124	1,317
CS483630	48 ¹ / ₈	36 ⁷ / ₁₆	140	1,416
CS552430	56 ¹ / ₈	24 ³ / ₄	124	1,358
CS553030	56 ¹ / ₈	30	138	1,404
CS553630	56 ¹ / ₈	36 ⁷ / ₁₆	154	1,482
CS602430	59 ¹³ / ₁₆	24 ³ / ₄	130	1,447
CS603030	59 ¹³ / ₁₆	30	143	1,537
CS603630	59 ¹³ / ₁₆	36 ⁷ / ₁₆	161	1,622
CS692430	69 ¹³ / ₁₆	24 ³ / ₄	158	1,609
CS693030	69 ¹³ / ₁₆	30	174	1,677
CS693630	69 ¹³ / ₁₆	36 ⁷ / ₁₆	195	1,779
CS722430	71 ¹ / ₂	24 ³ / ₄	164	1,743
CS723030	71 ¹ / ₂	30	180	1,813
CS723630	71 ¹ / ₂	36 ⁷ / ₁₆	201	1,919
CS842430	83 ¹ / ₂	24 ³ / ₄	190	2,126
CS843030	83 ¹ / ₂	30	209	2,183
CS843630	83 ¹ / ₂	36 ⁷ / ₁₆	232	2,311

30" High Full-Shelf with 3" Clearance

CS603030B

MODEL #	WIDTH	DEPTH	WEIGHT	PRICE
CS242430B	24 ³ / ₄	24 ³ / ₄	85	1,092
CS243030B	24 ³ / ₄	30	94	1,140
CS243630B	24 ³ / ₄	36 ⁷ / ₁₆	105	1,210
CS302430B	30	24 ³ / ₄	91	1,161
CS303030B	30	30	101	1,210
CS303630B	30	36 ⁷ / ₁₆	113	1,282
CS362430B	36 ⁷ / ₁₆	24 ³ / ₄	101	1,226
CS363030B	36 ⁷ / ₁₆	30	112	1,282
CS363630B	36 ⁷ / ₁₆	36 ⁷ / ₁₆	124	1,466
CS422430B	42 ⁷ / ₁₆	24 ³ / ₄	110	1,283
CS423030B	42 ⁷ / ₁₆	30	121	1,344
CS423630B	42 ⁷ / ₁₆	36 ⁷ / ₁₆	135	1,424
CS482430B	48 ¹ / ₈	24 ³ / ₄	118	1,345
CS483030B	48 ¹ / ₈	30	130	1,409
CS483630B	48 ¹ / ₈	36 ⁷ / ₁₆	145	1,509

30" High Full-Shelf with 3" Clearance (cont.)

MODEL #	WIDTH	DEPTH	WEIGHT	PRICE
CS552430B	56 ¹ / ₈	24 ³ / ₄	130	1,465
CS553030B	56 ¹ / ₈	30	143	1,511
CS553630B	56 ¹ / ₈	36 ⁷ / ₁₆	161	1,600
CS602430B	59 ¹³ / ₁₆	24 ³ / ₄	135	1,561
CS603030B	59 ¹³ / ₁₆	30	149	1,653
CS603630B	59 ¹³ / ₁₆	36 ⁷ / ₁₆	166	1,737
CS692430B	69 ¹³ / ₁₆	24 ³ / ₄	165	1,738
CS693030B	69 ¹³ / ₁₆	30	180	1,809
CS693630B	69 ¹³ / ₁₆	36 ⁷ / ₁₆	201	1,910
CS722430B	71 ¹ / ₂	24 ³ / ₄	169	1,880
CS723030B	71 ¹ / ₂	30	186	1,955
CS723630B	71 ¹ / ₂	36 ⁷ / ₁₆	207	2,054
CS842430B	83 ¹ / ₂	24 ³ / ₄	196	2,267
CS843030B	83 ¹ / ₂	30	216	2,326
CS843630B	83 ¹ / ₂	36 ⁷ / ₁₆	239	2,453

Options

MODIFICATION	MODEL # CHANGE	PRICE
Accepts wheels	CSwwdd30W	None
Adjustable legs	CSwwdd30A	54

36" High Full-Shelf with 9" Clearance

CS422436

MODEL #	WIDTH	DEPTH	WEIGHT	PRICE
CS242436	24 ³ / ₄	24 ³ / ₄	96	1,073
CS243036	24 ³ / ₄	30	107	1,148
CS243636	24 ³ / ₄	36 ⁷ / ₁₆	120	1,179
CS302436	30	24 ³ / ₄	106	1,127
CS303036	30	30	118	1,209
CS303636	30	36 ⁷ / ₁₆	132	1,244
CS362436	36 ⁷ / ₁₆	24 ³ / ₄	117	1,187
CS363036	36 ⁷ / ₁₆	30	130	1,273
CS363636	36 ⁷ / ₁₆	36 ⁷ / ₁₆	146	1,309
CS422436	42 ⁷ / ₁₆	24 ³ / ₄	128	1,235
CS423036	42 ⁷ / ₁₆	30	142	1,330
CS423636	42 ⁷ / ₁₆	36 ⁷ / ₁₆	160	1,368
CS482436	48 ¹ / ₈	24 ³ / ₄	139	1,282
CS483036	48 ¹ / ₈	30	154	1,374
CS483636	48 ¹ / ₈	36 ⁷ / ₁₆	173	1,466
CS552436	56 ¹ / ₈	24 ³ / ₄	153	1,366
CS553036	56 ¹ / ₈	30	169	1,465
CS553636	56 ¹ / ₈	36 ⁷ / ₁₆	190	1,517
CS602436	59 ¹³ / ₁₆	24 ³ / ₄	160	1,492
CS603036	59 ¹³ / ₁₆	30	177	1,622
CS603636	59 ¹³ / ₁₆	36 ⁷ / ₁₆	198	1,660
CS692436	69 ¹³ / ₁₆	24 ³ / ₄	196	1,660
CS693036	69 ¹³ / ₁₆	30	217	1,746
CS693636	69 ¹³ / ₁₆	36 ⁷ / ₁₆	243	1,834
CS722436	71 ¹ / ₂	24 ³ / ₄	202	1,790

36" High Full-Shelf with 9" Clearance (cont.)

MODEL #	WIDTH	DEPTH	WEIGHT	PRICE
CS723036	71 ¹ / ₂	30	224	1,886
CS723636	71 ¹ / ₂	36 ⁷ / ₁₆	251	1,971
CS842436	83 ¹ / ₂	24 ³ / ₄	234	2,177
CS843036	83 ¹ / ₂	30	259	2,262
CS843636	83 ¹ / ₂	36 ⁷ / ₁₆	288	2,381

36" High Full-Shelf with 3" Clearance



CS603636B

MODEL #	WIDTH	DEPTH	WEIGHT	PRICE
CS242436B	24 ³ / ₄	24 ³ / ₄	112	1,121
CS243036B	24 ³ / ₄	30	125	1,196
CS243636B	24 ³ / ₄	36 ⁷ / ₁₆	130	1,224
CS302436B	30	24 ³ / ₄	123	1,183
CS303036B	30	30	138	1,265
CS303636B	30	36 ⁷ / ₁₆	144	1,301
CS362436B	36 ⁷ / ₁₆	24 ³ / ₄	135	1,255
CS363036B	36 ⁷ / ₁₆	30	152	1,339
CS363636B	36 ⁷ / ₁₆	36 ⁷ / ₁₆	158	1,376
CS422436B	42 ⁷ / ₁₆	24 ³ / ₄	147	1,313
CS423036B	42 ⁷ / ₁₆	30	165	1,409
CS423636B	42 ⁷ / ₁₆	36 ⁷ / ₁₆	173	1,447
CS482436B	48 ¹ / ₈	24 ³ / ₄	160	1,373
CS483036B	48 ¹ / ₈	30	178	1,467
CS483636B	48 ¹ / ₈	36 ⁷ / ₁₆	211	1,557
CS552436B	56 ¹ / ₈	24 ³ / ₄	175	1,471
CS553036B	56 ¹ / ₈	30	196	1,567
CS553636B	56 ¹ / ₈	36 ⁷ / ₁₆	232	1,622
CS602436B	59 ¹³ / ₁₆	24 ³ / ₄	183	1,609
CS603036B	59 ¹³ / ₁₆	30	204	1,719
CS603636B	59 ¹³ / ₁₆	36 ⁷ / ₁₆	242	1,773
CS692436B	69 ¹³ / ₁₆	24 ³ / ₄	202	1,789
CS693036B	69 ¹³ / ₁₆	30	227	1,878
CS693636B	69 ¹³ / ₁₆	36 ⁷ / ₁₆	268	1,967
CS722436B	71 ¹ / ₂	24 ³ / ₄	209	1,927
CS723036B	71 ¹ / ₂	30	233	2,022
CS723636B	71 ¹ / ₂	36 ⁷ / ₁₆	276	2,105
CS842436B	83 ¹ / ₂	24 ³ / ₄	241	2,314
CS843036B	83 ¹ / ₂	30	267	2,398
CS843636B	83 ¹ / ₂	36 ⁷ / ₁₆	316	2,520

Options

MODIFICATION	MODEL # CHANGE	PRICE
Accepts wheels	CSwwdd36W	None
Adjustable legs	CSwwdd36A	54
42" height	CSwwdd42	153

30" Cabinet with 9" Clearance



CC302430

MODEL #	WIDTH	DEPTH	WEIGHT	PRICE
CC242430	24 ³ / ₄	24 ³ / ₄	94	1,127
CC243030	24 ³ / ₄	30	103	1,177
CC243630	24 ³ / ₄	36 ⁷ / ₁₆	116	1,254
CC302430	30	24 ³ / ₄	103	1,189
CC303030	30	30	114	1,236
CC303630	30	36 ⁷ / ₁₆	129	1,309
CC362430	36 ⁷ / ₁₆	24 ³ / ₄	117	1,253
CC363030	36 ⁷ / ₁₆	30	129	1,303
CC363630	36 ⁷ / ₁₆	36 ⁷ / ₁₆	144	1,385
CC422430	42 ⁷ / ₁₆	24 ³ / ₄	129	1,294
CC423030	42 ⁷ / ₁₆	30	142	1,355
CC423630	42 ⁷ / ₁₆	36 ⁷ / ₁₆	158	1,440
CC482430	48 ¹ / ₈	24 ³ / ₄	140	1,349
CC483030	48 ¹ / ₈	30	154	1,414
CC483630	48 ¹ / ₈	36 ⁷ / ₁₆	172	1,500
CC552430	56 ¹ / ₈	24 ³ / ₄	156	1,439
CC553030	56 ¹ / ₈	30	172	1,623
CC553630	56 ¹ / ₈	36 ⁷ / ₁₆	191	1,677
CC602430	59 ¹³ / ₁₆	24 ³ / ₄	164	1,514
CC603030	59 ¹³ / ₁₆	30	180	1,700
CC603630	59 ¹³ / ₁₆	36 ⁷ / ₁₆	200	1,756
CC692430	69 ¹³ / ₁₆	24 ³ / ₄	202	1,682
CC693030	69 ¹³ / ₁₆	30	221	1,871
CC693630	69 ¹³ / ₁₆	36 ⁷ / ₁₆	246	1,926
CC722430	71 ¹ / ₂	24 ³ / ₄	209	1,836
CC723030	71 ¹ / ₂	30	221	1,888
CC723630	71 ¹ / ₂	36 ⁷ / ₁₆	254	2,081
CC842430	83 ¹ / ₂	24 ³ / ₄	243	2,326
CC843030	83 ¹ / ₂	30	266	2,384
CC843630	83 ¹ / ₂	36 ⁷ / ₁₆	295	2,510

30" Cabinet with 3" Clearance



CC603030B

MODEL #	WIDTH	DEPTH	WEIGHT	PRICE
CC242430B	24 ³ / ₄	24 ³ / ₄	99	1,173
CC243030B	24 ³ / ₄	30	109	1,222
CC243630B	24 ³ / ₄	36 ⁷ / ₁₆	121	1,300
CC302430B	30	24 ³ / ₄	109	1,245
CC303030B	30	30	120	1,294
CC303630B	30	36 ⁷ / ₁₆	134	1,370
CC362430B	36 ⁷ / ₁₆	24 ³ / ₄	122	1,318
CC363030B	36 ⁷ / ₁₆	30	134	1,372
CC363630B	36 ⁷ / ₁₆	36 ⁷ / ₁₆	150	1,453
CC422430B	42 ⁷ / ₁₆	24 ³ / ₄	134	1,374
CC423030B	42 ⁷ / ₁₆	30	147	1,439
CC423630B	42 ⁷ / ₁₆	36 ⁷ / ₁₆	164	1,519
CC482430B	48 ¹ / ₈	24 ³ / ₄	145	1,443
CC483030B	48 ¹ / ₈	30	160	1,507
CC483630B	48 ¹ / ₈	36 ⁷ / ₁₆	177	1,593

30" Cabinet with 3" Clearance (cont.)

MODEL #	WIDTH	DEPTH	WEIGHT	PRICE
CC552430B	56 ⁷ / ₈	24 ³ / ₄	162	1,541
CC553030B	56 ⁷ / ₈	30	177	1,727
CC553630B	56 ⁷ / ₈	36 ⁷ / ₁₆	197	1,786
CC602430B	59 ¹³ / ₁₆	24 ³ / ₄	169	1,628
CC603030B	59 ¹³ / ₁₆	30	186	1,812
CC603630B	59 ¹³ / ₁₆	36 ⁷ / ₁₆	206	1,868
CC692430B	69 ¹³ / ₁₆	24 ³ / ₄	208	1,813
CC693030B	69 ¹³ / ₁₆	30	228	2,001
CC693630B	69 ¹³ / ₁₆	36 ⁷ / ₁₆	253	2,055
CC722430B	71 ¹ / ₂	24 ³ / ₄	216	1,974
CC723030B	71 ¹ / ₂	30	234	2,162
CC723630B	71 ¹ / ₂	36 ⁷ / ₁₆	261	2,220
CC842430B	83 ¹ / ₂	24 ³ / ₄	250	2,469
CC843030B	83 ¹ / ₂	30	273	2,526
CC843630B	83 ¹ / ₂	36 ⁷ / ₁₆	301	2,650

Options

MODIFICATION	MODEL # CHANGE	PRICE
Accepts wheels	CCwwdd30W	None
Adjustable legs	CCwwdd30A	54

36" Cabinet with 9" Clearance

CC363036

MODEL #	WIDTH	DEPTH	WEIGHT	PRICE
CC242436	24 ³ / ₄	24 ³ / ₄	103	1,162
CC243036	24 ³ / ₄	30	116	1,243
CC243636	24 ³ / ₄	36 ⁷ / ₁₆	129	1,278
CC302436	30	24 ³ / ₄	116	1,220
CC303036	30	30	128	1,303
CC303636	30	36 ⁷ / ₁₆	142	1,337
CC362436	36 ⁷ / ₁₆	24 ³ / ₄	127	1,283
CC363036	36 ⁷ / ₁₆	30	142	1,371
CC363636	36 ⁷ / ₁₆	36 ⁷ / ₁₆	158	1,409
CC422436	42 ⁷ / ₁₆	24 ³ / ₄	142	1,335
CC423036	42 ⁷ / ₁₆	30	156	1,423
CC423636	42 ⁷ / ₁₆	36 ⁷ / ₁₆	174	1,471
CC482436	48 ¹ / ₈	24 ³ / ₄	154	1,391
CC483036	48 ¹ / ₈	30	169	1,485
CC483636	48 ¹ / ₈	36 ⁷ / ₁₆	188	1,545
CC552436	56 ⁷ / ₈	24 ³ / ₄	172	1,482
CC553036	56 ⁷ / ₈	30	188	1,662
CC553636	56 ⁷ / ₈	36 ⁷ / ₁₆	209	1,718
CC602436	59 ¹³ / ₁₆	24 ³ / ₄	179	1,556
CC603036	59 ¹³ / ₁₆	30	197	1,737
CC603636	59 ¹³ / ₁₆	36 ⁷ / ₁₆	218	1,792
CC692436	69 ¹³ / ₁₆	24 ³ / ₄	221	1,726
CC693036	69 ¹³ / ₁₆	30	242	1,907
CC693636	69 ¹³ / ₁₆	36 ⁷ / ₁₆	267	1,967
CC722436	71 ¹ / ₂	24 ³ / ₄	229	1,878

36" Cabinet with 9" Clearance (cont.)

MODEL #	WIDTH	DEPTH	WEIGHT	PRICE
CC723036	71 ¹ / ₂	30	250	2,066
CC723636	71 ¹ / ₂	36 ⁷ / ₁₆	276	2,120
CC842436	83 ¹ / ₂	24 ³ / ₄	265	2,294
CC843036	83 ¹ / ₂	30	289	2,500
CC843636	83 ¹ / ₂	36 ⁷ / ₁₆	319	2,557

36" Cabinet with 3" Clearance

CC603036B

MODEL #	WIDTH	DEPTH	WEIGHT	PRICE
CC242436B	24 ³ / ₄	24 ³ / ₄	120	1,206
CC243036B	24 ³ / ₄	30	130	1,285
CC243636B	24 ³ / ₄	36 ⁷ / ₁₆	134	1,321
CC302436B	30	24 ³ / ₄	130	1,278
CC303036B	30	30	140	1,358
CC303636B	30	36 ⁷ / ₁₆	147	1,392
CC362436B	36 ⁷ / ₁₆	24 ³ / ₄	150	1,348
CC363036B	36 ⁷ / ₁₆	30	160	1,441
CC363636B	36 ⁷ / ₁₆	36 ⁷ / ₁₆	164	1,478
CC422436B	42 ⁷ / ₁₆	24 ³ / ₄	155	1,416
CC423036B	42 ⁷ / ₁₆	30	170	1,506
CC423636B	42 ⁷ / ₁₆	36 ⁷ / ₁₆	179	1,550
CC482436B	48 ¹ / ₈	24 ³ / ₄	170	1,484
CC483036B	48 ¹ / ₈	30	190	1,578
CC483636B	48 ¹ / ₈	36 ⁷ / ₁₆	210	1,623
CC552436B	56 ⁷ / ₈	24 ³ / ₄	177	1,586
CC553036B	56 ⁷ / ₈	30	194	1,764
CC553636B	56 ⁷ / ₈	36 ⁷ / ₁₆	215	1,821
CC602436B	59 ¹³ / ₁₆	24 ³ / ₄	185	1,668
CC603036B	59 ¹³ / ₁₆	30	202	1,851
CC603636B	59 ¹³ / ₁₆	36 ⁷ / ₁₆	223	1,906
CC692436B	69 ¹³ / ₁₆	24 ³ / ₄	228	1,859
CC693036B	69 ¹³ / ₁₆	30	249	2,040
CC693636B	69 ¹³ / ₁₆	36 ⁷ / ₁₆	274	2,096
CC722436B	71 ¹ / ₂	24 ³ / ₄	234	2,018
CC723036B	71 ¹ / ₂	30	255	2,207
CC723636B	71 ¹ / ₂	36 ⁷ / ₁₆	282	2,261
CC842436B	83 ¹ / ₂	24 ³ / ₄	271	2,434
CC843036B	83 ¹ / ₂	30	295	2,638
CC843636B	83 ¹ / ₂	36 ⁷ / ₁₆	326	2,699

Options

MODIFICATION	MODEL # CHANGE	PRICE
Accepts wheels	CCwwdd30W	None
Adjustable legs	CCwwdd30A	54
42" height	CCwwdd42	153

30" High Center Mount Modesty



CX483630

MODEL #	WIDTH	DEPTH	WEIGHT	PRICE
CX303030	30	30	92	1,057
CX303630	30	36 ⁷ / ₁₆	102	1,086
CX363030	36 ⁷ / ₁₆	30	100	1,093
CX363630	36 ⁷ / ₁₆	36 ⁷ / ₁₆	111	1,146
CX423030	42 ⁷ / ₁₆	30	108	1,121
CX423630	42 ⁷ / ₁₆	36 ⁷ / ₁₆	120	1,176
CX483030	48 ¹ / ₈	30	116	1,161
CX483630	48 ¹ / ₈	36 ⁷ / ₁₆	128	1,313
CX484830	48 ¹ / ₈	48	150	1,727
CX553030	56 ¹ / ₈	30	125	1,273
CX553630	56 ¹ / ₈	36 ⁷ / ₁₆	139	1,344
CX554830	56 ¹ / ₈	48	163	1,772
CX603030	59 ¹³ / ₁₆	30	130	1,316
CX603630	59 ¹³ / ₁₆	36 ⁷ / ₁₆	144	1,386
CX604830	59 ¹³ / ₁₆	48	168	1,856
CX693030	69 ¹³ / ₁₆	30	150	1,414
CX693630	69 ¹³ / ₁₆	36 ⁷ / ₁₆	167	1,490
CX694830	69 ¹³ / ₁₆	48	197	1,998
CX723030	71 ¹ / ₂	30	155	1,478
CX723630	71 ¹ / ₂	36 ⁷ / ₁₆	172	1,550
CX724830	71 ¹ / ₂	48	209	2,050
CX843030	83 ¹ / ₂	30	179	1,747
CX843630	83 ¹ / ₂	36 ⁷ / ₁₆	197	1,828
CX844830	83 ¹ / ₂	48	236	2,330

36" High Center Mount Modesty



CX484836

MODEL #	WIDTH	DEPTH	WEIGHT	PRICE
CX303036	30	30	102	1,084
CX303636	30	36 ⁷ / ₁₆	114	1,134
CX363036	36 ⁷ / ₁₆	30	111	1,093
CX363636	36 ⁷ / ₁₆	36 ⁷ / ₁₆	123	1,177
CX423036	42 ⁷ / ₁₆	30	119	1,145
CX423636	42 ⁷ / ₁₆	36 ⁷ / ₁₆	132	1,209
CX483036	48 ¹ / ₈	30	127	1,217
CX483636	48 ¹ / ₈	36 ⁷ / ₁₆	141	1,347
CX484836	48 ¹ / ₈	48	165	1,780
CX553036	56 ¹ / ₈	30	138	1,316
CX553636	56 ¹ / ₈	36 ⁷ / ₁₆	152	1,392
CX554836	56 ¹ / ₈	48	178	1,802
CX603036	59 ¹³ / ₁₆	30	142	1,366
CX603636	59 ¹³ / ₁₆	36 ⁷ / ₁₆	157	1,524
CX604836	59 ¹³ / ₁₆	48	185	1,890
CX693036	69 ¹³ / ₁₆	30	165	1,460
CX693636	69 ¹³ / ₁₆	36 ⁷ / ₁₆	183	1,541
CX694836	69 ¹³ / ₁₆	48	221	2,052
CX723036	71 ¹ / ₂	30	169	1,519
CX723636	71 ¹ / ₂	36 ⁷ / ₁₆	188	1,600
CX724836	71 ¹ / ₂	48	226	2,084
CX843036	83 ¹ / ₂	30	195	1,929
CX843636	83 ¹ / ₂	36 ⁷ / ₁₆	215	2,050
CX844836	83 ¹ / ₂	48	253	2,360

When modifying the door clearance and adding shelves or cabinets to a CX console, specify clearance first and shelf/cabinet second. For example, a CX603030 with optional 3" clearance and front cabinet is specified as CX603030BD.

Contact Hamilton Sorter for the constraints of wheels on CX consoles.

Options

MODEL #	DESCRIPTION	INCREASE
Hx	Front Shelf	87
HH	Front & Back Shelf	172
Dx	Front Cabinet	320
DD	Front & Back Cabinet	550
DH	Front Cabinet & Back Shelf	405
Bx	3" Clearance	110

**Doors indicated by "D" and require handle specification.

Specialty Consoles

How to Specify Your Options

MANIFEST SHIPPING CONSOLE

Model	Increase	Description
x	\$ 0	No Adjust
A	\$54	Adjustable Legs

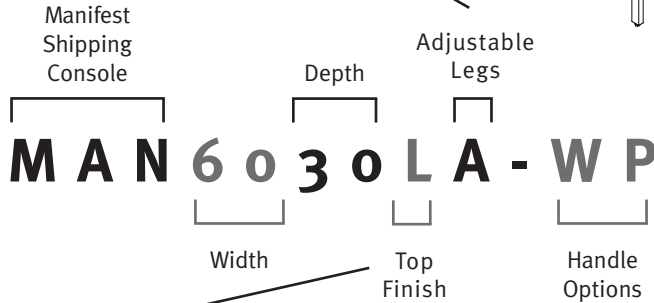
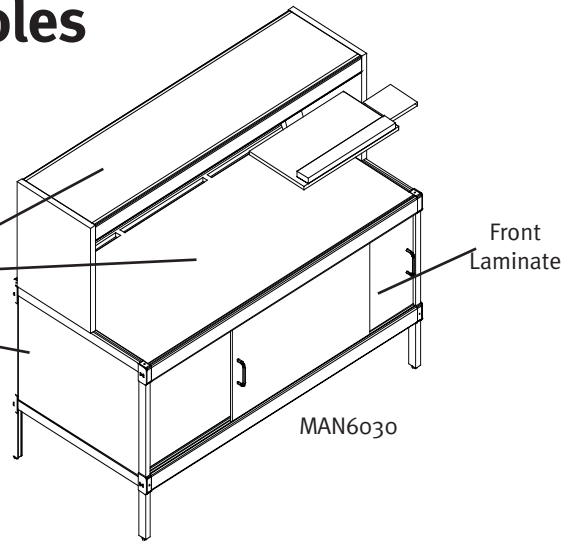

Increase Per Square		
Model	Foot	Description
L	\$ 0	Laminate
A	\$20	ABS
S	\$46	Stainless Steel

Handles†		
Model	Increase	Description
EL	\$0	Elliptical
CB	\$0	Crescent Black
CS	\$0	Crescent Silver
TC	\$0	Textured Crescent
FC	\$0	Flared Crescent
WP	\$0	Wired Pull (MR Zinc)
SP	\$0	Special Handle

†Recessed handle is not an option

See page 60 for color codes.

Notes

1. If you need a shipping console with a 3" floor clearance or with a 36" console height, you must order each component separately (console, platform and keyboard tray).
2. Shipping stations are shipped knocked down. When getting freight quotes, specify Class 85. If dimensions are required, use 10" for the height of the box and add 3" to the width and depth of the console.

CRANK ADJUSTABLE CONSOLE

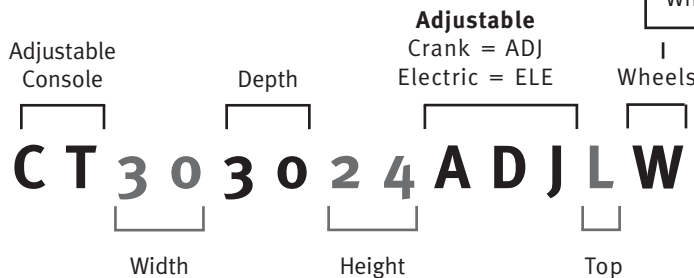

Model	Increase	Description
x	\$ 0	No Wheels
W	\$ 0	With Wheels

*Available on 30" and 36" widths only
*Wheels sold separately

Increase Per Square		
Model	Foot	Description
L	\$ 0	Laminate
A	\$20	ABS
S	\$46	Stainless Steel

Specialty Consoles

Manifest Shipping



MAN4830

MODEL #	WIDTH	DEPTH	HEIGHT	WEIGHT	PRICE
MAN4830	48 ⁷ / ₈	30	48	211	2,434
MAN6030	59 ¹³ / ₁₆	30	48	251	2,601
MAN7230	71 ¹ / ₂	30	48	286	2,804

Manifest Shipping Stations include a 30" d x 30" h cabinet console with a 9" floor clearance, three gromets in the rear of the worksurface, two cable cutouts in the back panel, and a 17⁵/₈ deep heavy-duty platform with an 8" high back panel. There is an open space between the back panel and the aluminum extrusion for cable management; and a keyboard tray with mousepad.

Packaging Station



PAC7230

MODEL #	WIDTH	DEPTH	HEIGHT	WEIGHT	PRICE
PAC7230	71 ¹ / ₂	30	48	318	2,864

Packaging Station consists of a CC723030 with ABS top, E721618 and four VLPT3030.

Options

MODIFICATION	MODEL # CHANGE	PRICE
Adjustable legs	xxxwwddA	54

Crank Adjustable



CT303024ADJ

MODEL #	WIDTH	DEPTH	HEIGHT	WEIGHT	PRICE
CT303024ADJ	30	30	28-40	187	1,628
CT363024ADJ	36 ⁷ / ₁₆	30	28-40	195	1,642
CT483024ADJ	48 ⁷ / ₈	30	28-40	202	1,724
CT603024ADJ	59 ¹³ / ₁₆	30	28-40	224	1,771

Electric Adjustable



CT363024ELE

MODEL #	WIDTH	DEPTH	HEIGHT	WEIGHT	PRICE
CT303024ELE	30	30	28-40	187	3,736
CT363024ELE	36 ⁷ / ₁₆	30	28-40	195	3,750
CT483024ELE	48 ⁷ / ₈	30	28-40	202	3,827
CT603024ELE	59 ¹³ / ₁₆	30	28-40	224	3,871

Accessories

MODEL #	DESCRIPTION	PRICE
WHL-ADJ	Set of 4 wheels for adjustable console Available for 30" and 36" widths only	30

Adjustable Scale



SU263030

MODEL #	WIDTH	DEPTH	HEIGHT	WEIGHT	PRICE
SU263030	26	30	30	90	927
SU263630	26	36 ⁷ / ₁₆	30	100	970
SU263036	26	30	36	100	984
SU263636	26	36 ⁷ / ₁₆	36	110	1,004

Platforms for Adjustable Scale



E262612

MODEL #	WIDTH	DEPTH	HEIGHT	WEIGHT	PRICE
E261612	26	16 ⁷ / ₈	12	27	279
E261618	26	16 ⁷ / ₈	18	33	298

Options

MODIFICATION	MODEL # CHANGE	PRICE
Aluminum extrusion platform	E2616hhM	83
Drill top for wire dividers	E2616hhD	27

With Rollers



CR363630

MODEL #	WIDTH	DEPTH	HEIGHT	WEIGHT	PRICE
CR363030	36 ⁷ / ₁₆	30	30	98	1,569
CR363036	36 ⁷ / ₁₆	30	36	108	1,603
CR363630	36 ⁷ / ₁₆	36 ⁷ / ₁₆	30	108	1,646
CR363636	36 ⁷ / ₁₆	36 ⁷ / ₁₆	36	119	1,678
CR483030	48 ⁷ / ₈	30	30	116	1,779
CR483036	48 ⁷ / ₈	30	36	126	1,836
CR483630	48 ⁷ / ₈	36 ⁷ / ₁₆	30	127	1,967
CR483636	48 ⁷ / ₈	36 ⁷ / ₁₆	36	139	1,997
CR603030	59 ¹³ / ₁₆	30	30	133	2,078
CR603036	59 ¹³ / ₁₆	30	36	144	2,123
CR603630	59 ¹³ / ₁₆	36 ⁷ / ₁₆	30	146	2,182
CR603636	59 ¹³ / ₁₆	36 ⁷ / ₁₆	36	158	2,219
CR723030	71 ¹ / ₂	30	30	152	2,380
CR723036	71 ¹ / ₂	30	36	164	2,422
CR723630	71 ¹ / ₂	36 ⁷ / ₁₆	30	166	2,496
CR723636	71 ¹ / ₂	36 ⁷ / ₁₆	36	164	2,546
CR843030	83 ¹ / ₂	30	30	176	2,628
CR843036	83 ¹ / ₂	30	36	189	2,791
CR843630	83 ¹ / ₂	36 ⁷ / ₁₆	30	186	2,658
CR843636	83 ¹ / ₂	36 ⁷ / ₁₆	36	205	2,954

Intermediate Shelf for Console

How to Specify Your Options
Base Laminate

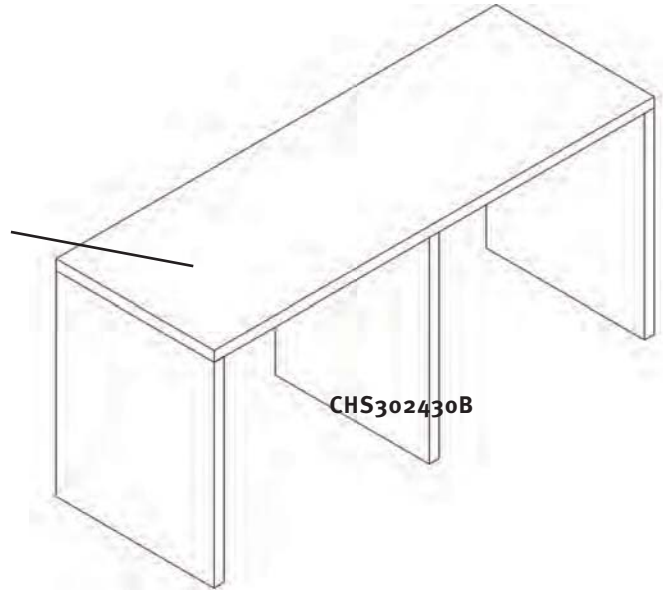

Type of Shelf
CH = Half Shelf
CF = Full Shelf

Clearance Option
B = 3"
Clearance
x = 9"
Clearance

CHS603630B - I



Dimensions of
Console for Shelf



Intermediate
Shelf

See page 60 for color codes.

Notes

1. Intermediate shelves are not fastened to the console shelf and can be removed.
2. Shelves are sent with double-faced adhesive tape for optional fastening.
3. Shelves 54" or wider feature a center leg for additional support.
4. Intermediate shelves are shipped knocked down. When getting freight quotes, specify Class 85. If dimensions are required, use 6" for height and add 3" to width and depth for packing materials.
5. Modifications to the width, depth and height can be made.

Intermediate Shelf Consoles

30" Half-Depth with 9" Clearance



CHS603030-1

MODEL #	WIDTH	DEPTH	WEIGHT	PRICE
CHS242430-1	22 ¹¹ / ₁₆	24 ³ / ₄	12	133
CHS243030-1	22 ¹¹ / ₁₆	30	13	142
CHS243630-1	22 ¹¹ / ₁₆	36 ⁷ / ₁₆	15	147
CHS302430-1	27 ¹⁵ / ₁₆	24 ³ / ₄	12	135
CHS303030-1	27 ¹⁵ / ₁₆	30	14	141
CHS303630-1	27 ¹⁵ / ₁₆	36 ⁷ / ₁₆	17	148
CHS362430-1	34 ³ / ₈	24 ³ / ₄	13	138
CHS363030-1	34 ³ / ₈	30	15	147
CHS363630-1	34 ³ / ₈	36 ⁷ / ₁₆	18	154
CHS422430-1	40 ³ / ₈	24 ³ / ₄	14	142
CHS423030-1	40 ³ / ₈	30	17	151
CHS423630-1	40 ³ / ₈	36 ⁷ / ₁₆	20	158
CHS482430-1	46 ¹ / ₁₆	24 ³ / ₄	14	147
CHS483030-1	46 ¹ / ₁₆	30	18	154
CHS483630-1	46 ¹ / ₁₆	36 ⁷ / ₁₆	21	169
CHS552430-1	54	24 ³ / ₄	18	158
CHS553030-1	54	30	21	187
CHS553630-1	54	36 ⁷ / ₁₆	25	200
CHS602430-1	57 ³ / ₄	24 ³ / ₄	18	162
CHS603030-1	57 ³ / ₄	30	22	190
CHS603630-1	57 ³ / ₄	36 ⁷ / ₁₆	26	201
CHS692430-1	67 ³ / ₄	24 ³ / ₄	20	166
CHS693030-1	67 ³ / ₄	30	24	187
CHS693630-1	67 ³ / ₄	36 ⁷ / ₁₆	29	208
CHS722430-1	69 ³ / ₈	24 ³ / ₄	20	168
CHS723030-1	69 ³ / ₈	30	24	190
CHS723630-1	69 ³ / ₈	36 ⁷ / ₁₆	29	215
CHS842430-1	81 ³ / ₈	24 ³ / ₄	21	183
CHS843030-1	81 ³ / ₈	30	26	200
CHS843630-1	81 ³ / ₈	36 ⁷ / ₁₆	32	234

All half-depth intermediate shelves for 30" consoles with 9" clearance have a height of 8¹/₂".

30" Half-Depth with 3" Clearance



CHS3024308-1

MODEL #	WIDTH	DEPTH	WEIGHT	PRICE
CHS242430B-1	22 ¹¹ / ₁₆	24 ³ / ₄	19	138
CHS243030B-1	22 ¹¹ / ₁₆	30	22	147
CHS243630B-1	22 ¹¹ / ₁₆	36 ⁷ / ₁₆	24	155
CHS302430B-1	27 ¹⁵ / ₁₆	24 ³ / ₄	20	143
CHS303030B-1	27 ¹⁵ / ₁₆	30	23	151
CHS303630B-1	27 ¹⁵ / ₁₆	36 ⁷ / ₁₆	25	160
CHS362430B-1	34 ³ / ₈	24 ³ / ₄	21	147
CHS363030B-1	34 ³ / ₈	30	23	158
CHS363630B-1	34 ³ / ₈	36 ⁷ / ₁₆	26	165
CHS422430B-1	40 ³ / ₈	24 ³ / ₄	22	151
CHS423030B-1	40 ³ / ₈	30	25	161
CHS423630B-1	40 ³ / ₈	36 ⁷ / ₁₆	29	169

30" Half-Depth with 3" Clearance (cont.)

MODEL #	WIDTH	DEPTH	WEIGHT	PRICE
CHS482430B-1	46 ¹ / ₁₆	24 ³ / ₄	22	155
CHS483030B-1	46 ¹ / ₁₆	30	25	165
CHS483630B-1	46 ¹ / ₁₆	36 ⁷ / ₁₆	30	185
CHS552430B-1	54	24 ³ / ₄	25	168
CHS553030B-1	54	30	31	202
CHS553630B-1	54	36 ⁷ / ₁₆	35	217
CHS602430B-1	57 ³ / ₄	24 ³ / ₄	26	168
CHS603030B-1	57 ³ / ₄	30	32	202
CHS603630B-1	57 ³ / ₄	36 ⁷ / ₁₆	36	221
CHS692430B-1	67 ³ / ₄	24 ³ / ₄	28	173
CHS693030B-1	67 ³ / ₄	30	33	179
CHS693630B-1	67 ³ / ₄	36 ⁷ / ₁₆	39	226
CHS722430B-1	69 ³ / ₈	24 ³ / ₄	29	174
CHS723030B-1	69 ³ / ₈	30	34	202
CHS723630B-1	69 ³ / ₈	36 ⁷ / ₁₆	40	230
CHS842430B-1	81 ³ / ₈	24 ³ / ₄	30	191
CHS843030B-1	81 ³ / ₈	30	36	216
CHS843630B-1	81 ³ / ₈	36 ⁷ / ₁₆	42	250

All half-depth intermediate shelves for 30" consoles with 3" clearance have a height of 13".

36" Half-Depth with 9" Clearance



CHS302436-1

MODEL #	WIDTH	DEPTH	WEIGHT	PRICE
CHS242436-1	22 ¹¹ / ₁₆	10	13	138
CHS243036-1	22 ¹¹ / ₁₆	13	17	147
CHS243636-1	22 ¹¹ / ₁₆	16	19	155
CHS302436-1	27 ¹⁵ / ₁₆	10	14	143
CHS303036-1	27 ¹⁵ / ₁₆	13	18	151
CHS303636-1	27 ¹⁵ / ₁₆	16	20	160
CHS362436-1	34 ³ / ₈	10	15	147
CHS363036-1	34 ³ / ₈	13	18	158
CHS363636-1	34 ³ / ₈	16	21	165
CHS422436-1	40 ³ / ₈	10	17	151
CHS423036-1	40 ³ / ₈	13	20	161
CHS423636-1	40 ³ / ₈	16	23	169
CHS482436-1	46 ¹ / ₁₆	10	17	155
CHS483036-1	46 ¹ / ₁₆	13	20	165
CHS483636-1	46 ¹ / ₁₆	16	24	185
CHS552436-1	54	10	20	167
CHS553036-1	54	13	25	201
CHS553636-1	54	16	30	217
CHS602436-1	57 ³ / ₄	10	21	168
CHS603036-1	57 ³ / ₄	13	26	202
CHS603636-1	57 ³ / ₄	16	31	221
CHS692436-1	67 ³ / ₄	10	22	173
CHS693036-1	67 ³ / ₄	13	28	194
CHS693636-1	67 ³ / ₄	16	33	226
CHS722436-1	69 ³ / ₈	10	23	174
CHS723036-1	69 ³ / ₈	13	29	202

36" Half-Depth with 9" Clearance (cont.)

MODEL #	WIDTH	DEPTH	WEIGHT	PRICE
CHS723636-I	69 ³ / ₈	16	34	230
CHS842436-I	81 ³ / ₈	10	24	191
CHS843036-I	81 ³ / ₈	13	31	216
CHS843636-I	81 ³ / ₈	16	36	250

All half-depth intermediate shelves for 36" consoles with 9" clearance have a height of 13".

36" Half-Depth with 3" Clearance

CHS603036B-I

MODEL #	WIDTH	DEPTH	WEIGHT	PRICE
CHS242436B-I	22 ¹¹ / ₁₆	10	18	147
CHS243036B-I	22 ¹¹ / ₁₆	13	19	151
CHS243636B-I	22 ¹¹ / ₁₆	16	21	162
CHS302436B-I	27 ¹⁵ / ₁₆	10	18	151
CHS303036B-I	27 ¹⁵ / ₁₆	13	20	155
CHS303636B-I	27 ¹⁵ / ₁₆	16	22	168
CHS362436B-I	34 ³ / ₈	10	19	155
CHS363036B-I	34 ³ / ₈	13	21	167
CHS363636B-I	34 ³ / ₈	16	23	173
CHS422436B-I	40 ³ / ₈	10	20	160
CHS423036B-I	40 ³ / ₈	13	22	169
CHS423636B-I	40 ³ / ₈	16	25	184
CHS482436B-I	46 ¹ / ₁₆	10	20	162
CHS483036B-I	46 ¹ / ₁₆	13	23	173
CHS483636B-I	46 ¹ / ₁₆	16	26	194
CHS552436B-I	54	10	23	170
CHS553036B-I	54	13	26	217
CHS553636B-I	54	16	31	230
CHS602436B-I	57 ³ / ₄	10	23	174
CHS603036B-I	57 ³ / ₄	13	28	219
CHS603636B-I	57 ³ / ₄	16	32	235
CHS692436B-I	67 ³ / ₄	10	25	184
CHS693036B-I	67 ³ / ₄	13	30	208
CHS693636B-I	67 ³ / ₄	16	34	240
CHS722436B-I	69 ³ / ₈	10	25	185
CHS723036B-I	69 ³ / ₈	13	30	219
CHS723636B-I	69 ³ / ₈	16	34	246
CHS842436B-I	81 ³ / ₈	10	26	202
CHS843036B-I	81 ³ / ₈	13	32	226
CHS843636B-I	81 ³ / ₈	16	37	268

All half-depth intermediate shelves for 36" consoles with 3" clearance have a height of 17".

Options

MODIFICATION	MODEL # CHANGE	PRICE
For 42" h consoles	CHSwwdd 42-I	+153

30" Full-Depth with 9" Clearance

CFS243630-I

MODEL #	WIDTH	DEPTH	WEIGHT	PRICE
CFS242430-I	22 ¹¹ / ₁₆	20	18	151
CFS243030-I	22 ¹¹ / ₁₆	26	22	158
CFS243630-I	22 ¹¹ / ₁₆	32	25	174
CFS302430-I	27 ¹⁵ / ₁₆	20	20	158
CFS303030-I	27 ¹⁵ / ₁₆	26	24	169
CFS303630-I	27 ¹⁵ / ₁₆	32	29	176
CFS362430-I	34 ³ / ₈	20	21	162
CFS363030-I	34 ³ / ₈	26	31	179
CFS363630-I	34 ³ / ₈	32	33	192
CFS422430-I	40 ³ / ₈	20	23	169
CFS423030-I	40 ³ / ₈	26	29	186
CFS423630-I	40 ³ / ₈	32	34	202
CFS482430-I	46 ¹ / ₁₆	20	24	176
CFS483030-I	46 ¹ / ₁₆	26	31	200
CFS483630-I	46 ¹ / ₁₆	32	36	215
CFS552430-I	54	20	30	191
CFS553030-I	54	26	37	215
CFS553630-I	54	32	45	230
CFS602430-I	57 ³ / ₄	20	31	194
CFS603030-I	57 ³ / ₄	26	40	217
CFS603630-I	57 ³ / ₄	32	47	237
CFS692430-I	67 ³ / ₄	20	34	203
CFS693030-I	67 ³ / ₄	26	43	229
CFS693630-I	67 ³ / ₄	32	52	253
CFS722430-I	69 ³ / ₈	20	34	207
CFS723030-I	69 ³ / ₈	26	44	234
CFS723630-I	69 ³ / ₈	32	53	256
CFS842430-I	81 ³ / ₈	20	37	230
CFS843030-I	81 ³ / ₈	26	48	258
CFS843630-I	81 ³ / ₈	32	59	285

All full-depth intermediate shelves for 30" consoles with 9" clearance have a height of 8¹/₂".

30" Full-Depth with 3" Clearance

CFS603030B-I

MODEL #	WIDTH	DEPTH	WEIGHT	PRICE
CFS242430B-I	22 ¹¹ / ₁₆	20	26	162
CFS243030B-I	22 ¹¹ / ₁₆	26	32	169
CFS243630B-I	22 ¹¹ / ₁₆	32	36	192
CFS302430B-I	27 ¹⁵ / ₁₆	20	29	169
CFS303030B-I	27 ¹⁵ / ₁₆	26	34	187
CFS303630B-I	27 ¹⁵ / ₁₆	32	40	202
CFS362430B-I	34 ³ / ₈	20	30	179
CFS363030B-I	34 ³ / ₈	26	36	192
CFS363630B-I	34 ³ / ₈	32	42	216
CFS422430B-I	40 ³ / ₈	20	32	185
CFS423030B-I	40 ³ / ₈	26	39	202
CFS423630B-I	40 ³ / ₈	32	45	223
CFS482430B-I	46 ¹ / ₁₆	20	33	188
CFS483030B-I	46 ¹ / ₁₆	26	41	208

30" Full-Depth with 3" Clearance* (cont.)

MODEL #	WIDTH	DEPTH	WEIGHT	PRICE
CFS483630B-I	46 ¹ / ₁₆	32	47	233
CFS552430B-I	54	20	41	203
CFS553030B-I	54	26	50	229
CFS553630B-I	54	32	59	250
CFS602430B-I	57 ³ / ₄	20	42	207
CFS603030B-I	57 ³ / ₄	26	52	234
CFS603630B-I	57 ³ / ₄	32	62	256
CFS692430B-I	67 ³ / ₄	20	45	221
CFS693030B-I	67 ³ / ₄	26	55	246
CFS693630B-I	67 ³ / ₄	32	66	273
CFS722430B-I	69 ³ / ₈	20	45	223
CFS723030B-I	69 ³ / ₈	26	56	250
CFS723630B-I	69 ³ / ₈	32	67	279
CFS842430B-I	81 ³ / ₈	20	48	244
CFS843030B-I	81 ³ / ₈	26	62	277
CFS843630B-I	81 ³ / ₈	32	74	308

All full-depth intermediate shelves for 30" consoles with 3" clearance have a height of 13".

36" Full-Depth with 9" Clearance



CFS603036-I

MODEL #	WIDTH	DEPTH	WEIGHT	PRICE
CFS242436-I	22 ¹¹ / ₁₆	20	21	165
CFS243036-I	22 ¹¹ / ₁₆	26	26	169
CFS243636-I	22 ¹¹ / ₁₆	32	31	192
CFS302436-I	27 ¹⁵ / ₁₆	20	23	169
CFS303036-I	27 ¹⁵ / ₁₆	26	29	187
CFS303636-I	27 ¹⁵ / ₁₆	32	34	202
CFS362436-I	34 ³ / ₈	20	24	179
CFS363036-I	34 ³ / ₈	26	31	192
CFS363636-I	34 ³ / ₈	32	36	216
CFS422436-I	40 ³ / ₈	20	26	185
CFS423036-I	40 ³ / ₈	26	33	201
CFS423636-I	40 ³ / ₈	32	40	223
CFS482436-I	46 ¹ / ₁₆	20	28	188
CFS483036-I	46 ¹ / ₁₆	26	35	208
CFS483636-I	46 ¹ / ₁₆	32	42	233
CFS552436-I	54	20	35	203
CFS553036-I	54	26	44	229
CFS553636-I	54	32	54	250
CFS602436-I	57 ³ / ₄	20	36	207
CFS603036-I	57 ³ / ₄	26	46	234
CFS603636-I	57 ³ / ₄	32	56	256
CFS692436-I	67 ³ / ₄	20	40	221
CFS693036-I	67 ³ / ₄	26	50	246
CFS693636-I	67 ³ / ₄	32	61	273
CFS722436-I	69 ³ / ₈	20	40	223
CFS723036-I	69 ³ / ₈	26	51	250
CFS723636-I	69 ³ / ₈	32	62	279

36" Full-Depth with 9" Clearance (cont.)

MODEL #	WIDTH	DEPTH	WEIGHT	PRICE
CFS842436-I	81 ³ / ₈	20	43	244
CFS843036-I	81 ³ / ₈	26	56	277
CFS843636-I	81 ³ / ₈	32	68	308

All full-depth intermediate shelves for 36" consoles with 9" clearance have a height of 13".

36" Full-Depth with 3" Clearance



CFS362436B-I

MODEL #	WIDTH	DEPTH	WEIGHT	PRICE
CFS242436B-I	22 ¹¹ / ₁₆	20	23	179
CFS243036B-I	22 ¹¹ / ₁₆	26	38	184
CFS243636B-I	22 ¹¹ / ₁₆	32	31	216
CFS302436B-I	27 ¹⁵ / ₁₆	20	25	184
CFS303036B-I	27 ¹⁵ / ₁₆	26	30	202
CFS303636B-I	27 ¹⁵ / ₁₆	32	34	230
CFS362436B-I	34 ³ / ₈	20	26	190
CFS363036B-I	34 ³ / ₈	26	32	207
CFS363636B-I	34 ³ / ₈	32	36	233
CFS422436B-I	40 ³ / ₈	20	29	194
CFS423036B-I	40 ³ / ₈	26	34	222
CFS423636B-I	40 ³ / ₈	32	40	240
CFS482436B-I	46 ¹ / ₁₆	20	30	200
CFS483036B-I	46 ¹ / ₁₆	26	35	207
CFS483636B-I	46 ¹ / ₁₆	32	42	250
CFS552436B-I	54	20	35	221
CFS553036B-I	54	26	43	243
CFS553636B-I	54	32	51	270
CFS602436B-I	57 ³ / ₄	20	36	223
CFS603036B-I	57 ³ / ₄	26	45	250
CFS603636B-I	57 ³ / ₄	32	53	279
CFS692436B-I	67 ³ / ₄	20	40	233
CFS693036B-I	67 ³ / ₄	26	48	263
CFS693636B-I	67 ³ / ₄	32	57	292
CFS722436B-I	69 ³ / ₈	20	40	235
CFS723036B-I	69 ³ / ₈	26	50	268
CFS723636B-I	69 ³ / ₈	32	58	298
CFS842436B-I	81 ³ / ₈	20	43	256
CFS843036B-I	81 ³ / ₈	26	54	295
CFS843636B-I	81 ³ / ₈	32	65	329

All full-depth intermediate shelves for 36" consoles with 3" clearance have a height of 17".

Options

MODIFICATION	MODEL # CHANGE	PRICE
For 42" h consoles	CHSwddd 42-I	+153

Console Accessories

How to Specify Your Options

DUMP RIMS

1. Dump rims can be added to an individual console or around the perimeter of configurations.
2. Dump rim model numbers represent the length of the console edge specified.
3. Specify side dump rims by adding 'S' to the end of the model number. Specify angled side rims by adding 'AS' to the end of the model number. Side dump rims for consoles with modules are also available.
4. To order 3-sided dump rims around a single console, order the following quantities:

Example: CC603030

Model #	Quantity
DR60	1
DR30AS	2
DRB-L	2 (to connect dump rims at corners)

When placing two consoles side-by-side with 3-sided dump rims across the full width of the consoles, order the following quantities:

Example: (2) CC603030

Model #	Quantity
DR60	2
DR30AS	2
DRB-L	2
DRB-H	1 (to connect dump rims across the console backs)

BRACKETS

All consoles are shipped with an interior bracket to connect adjacent tables. A CX-Clip is a decorative exterior bracket option.



Interior Bracket



CX-Clip

WHEELS

1. Wheels (5" diameter) are recommended for consoles up to 60" wide x 36" deep.

2. When ordering consoles with wheels, add 'W' to the end of the model number to keep the overall height standard. The normal wheel configuration is four swivel wheels.

Notes

1. A wrapping feature can be added to CS and CC consoles. This includes a paper-holder mounted to the shelf designed to hold up to 25^{13/16}" or 31^{13/16}" wide rolls, a knife bar mounted to the top and a slot in the left side of the console top. Specify alternative locations if desired.

2. When ordering MRSLOT, specify slot width, depth and location from the edge of the console. MRSLOT-10CONFIG and MRSLOT-13CONFIG pre-assign hole locations for mail slots at 3" from the console edge, front or rear of console must be specified, consoles up to 48" wide come with (2) mail slot grommet inserts, 48" and wider, (3).

3. CC consoles can be fitted with plunger locks. Order LOCK-M and specify which tables.

4. Special impact-resistant (ABS and stainless steel) surfaces are available. Specify which consoles require the special surface.

5. Fixed, vertical partitions can be specified for CS or CC consoles. Specify location, spacing and laminate. Partitions can also be field installed by mounting to aluminum channel.

6. To electrify a console, order a pop-up power center and, if necessary, a grommet (MRCBLCO-3).

7. MRDR16-3-20 and MRML-16-S cannot be mounted under CC consoles. Freestanding pedestals and pedestals with casters can only be mounted under CT, CS or CH consoles.

Console Accessories

MODEL #	DESCRIPTION	PRICE
DR24	For 24" wide consoles	64
DR30	For 30" wide consoles	70
DR36	For 36" wide consoles	74
DR42	For 42" wide consoles	77
DR48	For 48" wide consoles	83
DR55	For 55" wide consoles	87
DR60	For 60" wide consoles	90
DR69	For 69" wide consoles	101
DR72	For 72" wide consoles	103
DR84	For 84" wide consoles	110

Straight Side Dump Rims



DR24S

MODEL #	DESCRIPTION	PRICE
DR24S	24" deep consoles	62
DR30S	30" deep consoles	69
DR36S	36" deep consoles	75
DR48S	48" deep consoles	83

Angled Side Dump Rims



DR24AS

MODEL #	DESCRIPTION	PRICE
DR24AS	24" deep consoles	62
DR30AS	30" deep consoles	69
DR36AS	36" deep consoles	75
DR48AS	48" deep consoles	83

Straight Side Dump Rims for Module Table



DR11S

MODEL #	DESCRIPTION	PRICE
DR11S	24" deep consoles with standard/zip module	53
DR16S	30" deep consoles with standard/zip module	54
DR12S	30" deep consoles with legal/oversize module	55
DR22S	36" deep consoles with standard/zip module	57
DR18S	36" deep consoles with legal/oversize module	59

Angled Side Dump Rims for Module Table



DR11AS

MODEL #	DESCRIPTION	PRICE
DR11AS	24" deep consoles with standard/zip module	53
DR16AS	30" deep consoles with standard/zip module	54
DR12AS	30" deep consoles with legal/oversize module	55
DR22AS	36" deep consoles with standard/zip module	57
DR18AS	36" deep consoles with legal/oversize module	59

Dump Rim Brackets



DRB-H

MODEL #	DESCRIPTION	PRICE
DRB-H	H bracket for dump rims	7
DRB-L	L bracket for dump rims	7

Wheels



MODEL #	DESCRIPTION	PRICE
WHL-50ST	5" Straight wheel	32
WHL-50S	5" Swivel wheel	32
WHL-50ST	WHL-50SWB 5" Swivel wheel with brake	44

Clip



CX-Clip

MODEL #	DESCRIPTION	PRICE
CX-Clip	2" w console connector	19

Special Features

MODEL #	DESCRIPTION	PRICE
WRAP30	Wrapping feature for 30" d console	165
WRAP36	Wrapping feature for 36" d console	165
MRSLOT	Paper/mail slot - specify size & location	48
MRSLOT-10	1.5"x10" slot w/ plastic grommet - spec. location	47
MRSLOT-13	2"x13" slot w/ plastic grommet - spec. location	51
MRSLOT-10CONFIG*	MRSLOT-10 configuration	89
MRSLOT-13CONFIG*	MRSLOT-13 configuration	97
LOCK-M	Plunger lock for CC consoles	42
ABSwwdd	ABS top (price per square foot)	22
SSTwwdd	Stainless steel top (price per square foot)	50

*Slot configurations include two slots on consoles up to 48" w, three slots on consoles wider than 48", three slots on. Specify front or back.

Undertable Vertical Partitions

MODEL #	DESCRIPTION	PRICE
VLPT2430	Partition for ww2430 console	70
VLPT2436	Partition for ww2436 console	70
VLPT3030	Partition for ww3030 console	70
VLPT3036	Partition for ww3036 console	70
VLPT3630	Partition for ww3630 console	70
VLPT3636	Partition for ww3636 console	70
VLPT2430B	Partition for ww2430B console	70
VLPT2436B	Partition for ww2436B console	70
VLPT3030B	Partition for ww3030B console	70
VLPT3036B	Partition for ww3036B console	70
VLPT3630B	Partition for ww3630B console	70
VLPT3636B	Partition for ww3636B console	70

Cable Management

MODEL #	DESCRIPTION	PRICE
MRCBLR-36	Cable raceway for 36" w console	37
MRCBLR-48	Cable raceway for 48" w console	50
MRCBLR-60	Cable raceway for 60" w console	61
MRCBLR-72	Cable raceway for 72" w console	75
MRCBLCO-3	3 ¹ / ₄ " diameter cable cutout - specify location	20

Electrical Options & Undertable Accessories

MRRPC-3

MODEL #	DESCRIPTION	WEIGHT	PRICE
MRMOPS-SP-6	6-outlet power strip (12"L)	n/a	71
MRRPC-3	Retractable power center	n/a	182
MRKDADJ	Adj. keyboard drawer	15	306
MRKDADJM	Adj. keyboard drawer with mouse	16	406

Undertable Accessories

MRDL16-27

MODEL #	WIDTH	DEPTH	HEIGHT	WEIGHT	PRICE
Pencil Drawer					
MRDR16-3-20	20	17 ¹ / ₈	27 ⁷ / ₈	15	166
Two-Drawer Suspended Pedestal					
MRML16-S	15 ⁵ / ₈	17 ¹³ / ₁₆	18 ¹ / ₂	70	456
Two-Drawer Pedestal					
MRDL16-27	15 ¹³ / ₁₆	18 ³ / ₄	27	80	722
MRDL16-33	15 ¹³ / ₁₆	18 ³ / ₄	33	85	759
Three-Drawer Pedestal					
MRTL16-27	15 ¹³ / ₁₆	18"	27	85	722
MRTL16-33	15 ¹³ / ₁₆	18 ³ / ₄	33	90	759
Two-Drawer Pedestal with Casters					
MRML16-C	15 ¹³ / ₁₆	18 ³ / ₄	20 ¹ / ₂	80	484
MRDL16-33-C	15 ¹³ / ₁₆	18 ³ / ₄	32	89	818
Three-Drawer Pedestal with Casters					
MRTL16-33-C	15 ¹³ / ₁₆	18 ³ / ₄	33	95	818

Anti-Fatigue Mats

MODEL #	WIDTH	DEPTH	THICKNESS	PRICE
Comfort Eze				
MR447-2436	24	36	3/8	62
MR447-3060	30	60	3/8	124
Marble Sof-Tyle				
MR470-2436	24	36	1/2	82
MR470-3660	36	60	1/2	200

Anti-Fatigue Mats reduce stress and fatigue to mail-room personnel and are rated for different uses:

PRODUCT	USE	WEAR	ANTI-SLIP	ANTI-FATIGUE
Comfort Eze	Heavy Duty	Superior	Superior	Superior
Sof-Tyle	Heavy Duty	Superior	Fair	Superior

Platform

How to Specify Your Options

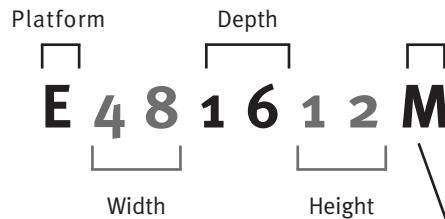
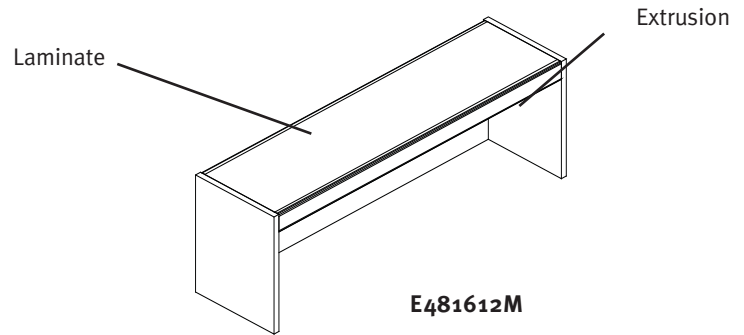

See page 60 for color codes.

Model	Increase	Description
M	\$83	Aluminum Extrusion*
X	\$0	No Extrusion

*Aluminum extrusion required to mount keyboard tray

Notes

1. Three-inch high platforms feature a closed front and closed back. They are fastened to the console with a locking cam accessed from outside the platform.
2. Platforms 6" high and 54" or wider, with no aluminum extrusion, feature a center support leg.
3. Platforms higher than 6" are supported with a 2" fascia across the front.
4. Platform width should equal the width of the console on which it will be used so that it can fasten to the console at both ends.
5. Platforms 12" or higher may be ordered with front and back aluminum extrusions by adding 'M' to the end of the model number. Twelve inch platforms feature a 5" back panel and the 18" h platforms a 8"h back panel. Both have an open area between the back panel and the extrusion for cable management.
6. A keyboard tray may be mounted on the aluminum extrusion platform and positioned anywhere along the width of the extrusion. Keyboards cannot be mounted on platforms without extrusions. Keyboards must be ordered separately (See page 48 and 51).
7. Platforms without aluminum extrusions have full backs with a 1³/₁₆" black, cable-management gasket located at the bottom of the back panel.
8. Platforms are shipped knocked down. When getting freight quotes specify Class 85. If dimensions are required, use 6" for the height and add 3" to the width and depth for packing materials.
9. Modifications to the width, depth and height can be made.

Platforms

3" High Platforms

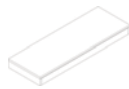

E361203

MODEL #	WIDTH	DEPTH	WEIGHT	PRICE
E241203	24 ^{3/4}	12 ^{7/8}	15	211
E241603	24 ^{3/4}	16 ^{7/8}	19	216
E281203	28 ^{3/4}	12 ^{7/8}	16	216
E281603	28 ^{3/4}	16 ^{7/8}	20	222
E301203	30	12 ^{7/8}	20	222
E301603	30	16 ^{7/8}	23	229
E361203	36 ^{7/16}	12 ^{7/8}	23	222
E361603	36 ^{7/16}	16 ^{7/8}	23	229
E421203	42 ^{7/16}	12 ^{7/8}	24	240
E421603	42 ^{7/16}	16 ^{7/8}	25	238
E481203	48 ^{1/8}	12 ^{7/8}	23	246
E481603	48 ^{1/8}	16 ^{7/8}	28	238
E551203	56 ^{1/8}	12 ^{7/8}	28	229
E551603	56 ^{1/8}	16 ^{7/8}	32	240
E601203	59 ^{13/16}	12 ^{7/8}	29	272
E601603	59 ^{13/16}	16 ^{7/8}	34	282
E691203	69 ^{13/16}	12 ^{7/8}	31	289
E691603	69 ^{13/16}	16 ^{7/8}	37	294
E721203	71 ^{1/2}	12 ^{7/8}	32	289
E721603	71 ^{1/2}	16 ^{7/8}	39	302
E841203	83 ^{1/2}	12 ^{7/8}	36	312
E841603	83 ^{1/2}	16 ^{7/8}	43	330

6" High Platforms



E361206

MODEL #	WIDTH	DEPTH	WEIGHT	PRICE
E241206	24 ^{3/4}	12 ^{7/8}	15	222
E241606	24 ^{3/4}	16 ^{7/8}	19	227
E281206	28 ^{3/4}	12 ^{7/8}	16	227
E281606	28 ^{3/4}	16 ^{7/8}	20	234
E301206	30	12 ^{7/8}	20	234
E301606	30	16 ^{7/8}	23	243
E361206	36 ^{7/16}	12 ^{7/8}	23	234
E361606	36 ^{7/16}	16 ^{7/8}	23	243
E421206	42 ^{7/16}	12 ^{7/8}	24	253
E421606	42 ^{7/16}	16 ^{7/8}	25	250
E481206	48 ^{1/8}	12 ^{7/8}	23	258
E481606	48 ^{1/8}	16 ^{7/8}	28	250
E551206	56 ^{1/8}	12 ^{7/8}	28	243
E551606	56 ^{1/8}	16 ^{7/8}	32	253
E601206	59 ^{13/16}	12 ^{7/8}	29	284
E601606	59 ^{13/16}	16 ^{7/8}	34	298
E691206	69 ^{13/16}	12 ^{7/8}	31	302
E691606	69 ^{13/16}	16 ^{7/8}	37	308
E721206	71 ^{1/2}	12 ^{7/8}	32	302
E721606	71 ^{1/2}	16 ^{7/8}	39	319
E841206	83 ^{1/2}	12 ^{7/8}	36	329
E841606	83 ^{1/2}	16 ^{7/8}	43	347

Options

MODIFICATION	MODEL # CHANGE	PRICE
Drill top for wire dividers	EwwddhhD	+27
Aluminum extrusion option not available on 3" and 6" high platforms.		

12" High Platforms



E301612

MODEL #	WIDTH	DEPTH	WEIGHT	PRICE
E241212	24 ^{3/4}	12 ^{7/8}	22	261
E241612	24 ^{3/4}	16 ^{7/8}	25	272
E281212	28 ^{3/4}	12 ^{7/8}	25	271
E281612	28 ^{3/4}	16 ^{7/8}	28	279
E301212	30	12 ^{7/8}	26	279
E301612	30	16 ^{7/8}	31	282
E361212	36 ^{7/16}	12 ^{7/8}	26	274
E361612	36 ^{7/16}	16 ^{7/8}	31	271
E421212	42 ^{7/16}	12 ^{7/8}	33	282
E421612	42 ^{7/16}	16 ^{7/8}	33	302
E481212	48 ^{1/8}	12 ^{7/8}	31	302
E481612	48 ^{1/8}	16 ^{7/8}	36	313
E551212	56 ^{1/8}	12 ^{7/8}	44	350
E551612	56 ^{1/8}	16 ^{7/8}	44	371
E601212	59 ^{13/16}	12 ^{7/8}	40	359
E601612	59 ^{13/16}	16 ^{7/8}	46	377
E691212	69 ^{13/16}	12 ^{7/8}	45	371
E691612	69 ^{13/16}	16 ^{7/8}	51	386
E721212	71 ^{1/2}	12 ^{7/8}	44	383
E721612	71 ^{1/2}	16 ^{7/8}	53	400
E841212	83 ^{1/2}	12 ^{7/8}	50	412
E841612	83 ^{1/2}	16 ^{7/8}	58	433

18" High Platforms



E361618

MODEL #	WIDTH	DEPTH	WEIGHT	PRICE
E241218	24 ^{3/4}	12 ^{7/8}	28	280
E241618	24 ^{3/4}	16 ^{7/8}	32	292
E281218	28 ^{3/4}	12 ^{7/8}	31	290
E281618	28 ^{3/4}	16 ^{7/8}	34	298
E301218	30	12 ^{7/8}	33	298
E301618	30	16 ^{7/8}	39	308
E361218	36 ^{7/16}	12 ^{7/8}	33	296
E361618	36 ^{7/16}	16 ^{7/8}	39	308
E421218	42 ^{7/16}	12 ^{7/8}	42	308
E421618	42 ^{7/16}	16 ^{7/8}	42	329
E481218	48 ^{1/8}	12 ^{7/8}	39	317
E481618	48 ^{1/8}	16 ^{7/8}	45	343
E551218	56 ^{1/8}	12 ^{7/8}	57	308
E551618	56 ^{1/8}	16 ^{7/8}	57	329
E601218	59 ^{13/16}	12 ^{7/8}	51	395
E601618	59 ^{13/16}	16 ^{7/8}	58	406
E691218	69 ^{13/16}	12 ^{7/8}	56	414

18" High Platforms (cont.)

MODEL #	WIDTH	DEPTH	WEIGHT	PRICE
E691618	69 ^{13/16}	16 ^{7/8}	64	433
E721218	71 ^{1/2}	12 ^{7/8}	56	406
E721618	71 ^{1/2}	16 ^{7/8}	66	422
E841218	83 ^{1/2}	12 ^{7/8}	63	422
E841618	83 ^{1/2}	16 ^{7/8}	74	443

Options

MODIFICATION	MODEL # CHANGE	PRICE
Aluminum extrusion platform	EwwddhhM	+83
Drill top for wire dividers	EwwddhhD	+27

Aluminum extrusion option adds 3/4" to the overall depth of the platform.

24" High Platforms

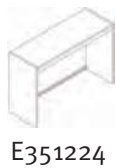

MODEL #	WIDTH	DEPTH	WEIGHT	PRICE
E241224	24 ^{3/4}	12 ^{7/8}	33	298
E241624	24 ^{3/4}	16 ^{7/8}	39	311
E281224	28 ^{3/4}	12 ^{7/8}	38	308
E281624	28 ^{3/4}	16 ^{7/8}	41	321
E301224	30	12 ^{7/8}	40	319
E301624	30	16 ^{7/8}	46	332
E361224	36 ^{7/16}	12 ^{7/8}	43	319
E361624	36 ^{7/16}	16 ^{7/8}	48	332
E421224	42 ^{7/16}	12 ^{7/8}	45	332
E421624	42 ^{7/16}	16 ^{7/8}	52	354
E481224	48 ^{1/8}	12 ^{7/8}	46	330
E481624	48 ^{1/8}	16 ^{7/8}	54	370
E551224	56 ^{1/8}	12 ^{7/8}	70	332
E551624	56 ^{1/8}	16 ^{7/8}	70	354
E601224	59 ^{13/16}	12 ^{7/8}	62	429
E601624	59 ^{13/16}	16 ^{7/8}	70	436
E691224	69 ^{13/16}	12 ^{7/8}	68	438
E691624	69 ^{13/16}	16 ^{7/8}	77	446
E721224	71 ^{1/2}	12 ^{7/8}	68	429
E721624	71 ^{1/2}	16 ^{7/8}	79	446
E841224	83 ^{1/2}	12 ^{7/8}	76	433
E841624	83 ^{1/2}	16 ^{7/8}	89	449

Options

MODIFICATION	MODEL # CHANGE	PRICE
Aluminum extrusion platform	EwwddhhM	+83
Drill top for wire dividers	EwwddhhD	+27

Aluminum extrusion option adds 3/4" to the overall depth of the platform.

Platform Accessories



MODEL #	DESCRIPTION	WEIGHT	PRICE
MRKDADJ	Adj. keyboard drawer	15	305
MRKDADJM	Adj. keyboard drawer with mouse	16	406
MRUSTL-24	24" black undersurface task light	10	140
MRTBwwhh	Tackboard (per sq. foot)	n/a	24

Executive Series Consoles

How to Specify Your Options

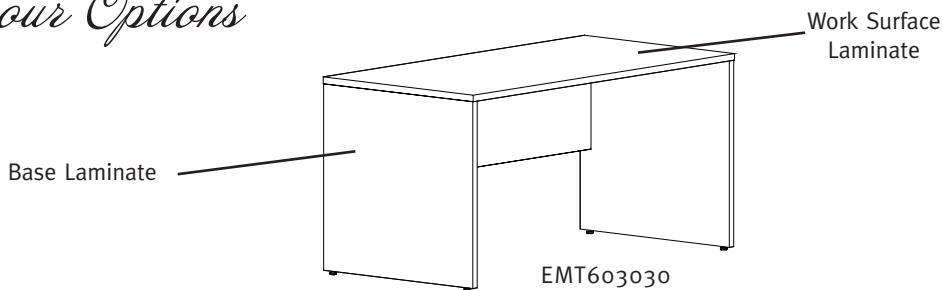

EXECUTIVE CONSOLE

Legs		
Model	Increase	Description
HR	\$56	Half right leg
HL	\$56	Half left leg
HLHR	\$112	Half left/half right

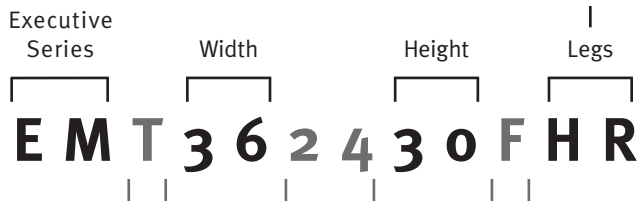

Shelf
 T = Table without Shelf
 S = Table with Shelf

Depth Modesty Panel

Modesty Panel		
Model	Increase	Description
x	\$0	Standard Modesty
F	\$111	Full Modesty

EXECUTIVE CONSOLE WITH SHELF

Locks		
Model	Increase	Description
x	\$0	No locks
Y	\$38	Locks

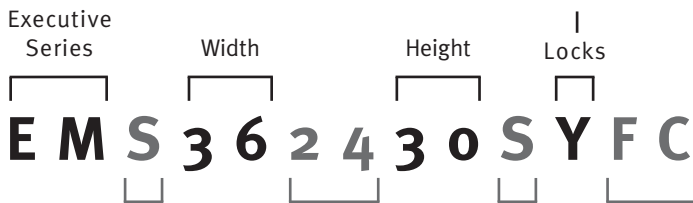

Shelf
 T = Table without Shelf
 S = Table with Shelf

Depth Sliding Doors Handle Options

Sliding Doors		
Model	Increase	Description
x	\$0	No doors
S	\$198	Sliding doors

Handles†		
Model	Increase	Description
EL	\$0	Elliptical
CB	\$0	Crescent Black
CS	\$0	Crescent Silver
TC	\$0	Textured Crescent
FC	\$0	Flared Crescent
WP	\$0	Wired Pull (MR Zinc)
SP	\$0	Special Handle

†Recessed handle is not an option

See page 60 for color codes.

Executive Series Consoles (con't.)

EXECUTIVE OVERHEAD

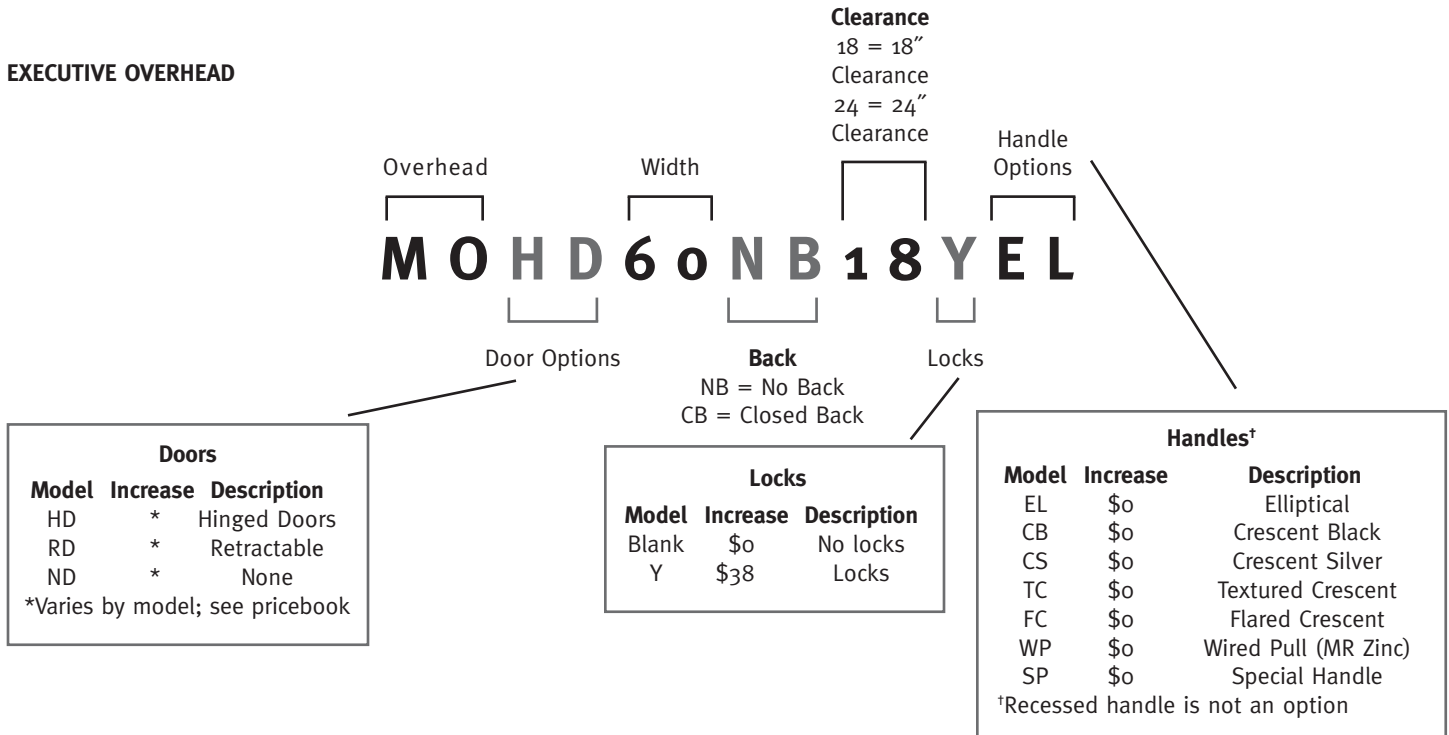

Console Notes

- Executive Consoles are light-use equipment with no aluminum extrusions and are not intended for general mail center use.
- The standard modesty panel in an EMT Console is 15³/₄"h. A full modesty panel can be ordered by adding 'F' to the end of the model number.
- When using modules on EMT Consoles, use a full modesty panel for extra support.
- EMS Consoles feature a full-depth shelf located 3" above the floor. Clearance between the shelf and worksurface is 24".
- Grommets are not standard in Executive Mail Consoles. Order MRCBLCO-3 and specify a grommet location.
- Counter Consoles include a 30"d, 29¹/₂"h workstations and a 16"d counter surface with a radius edge.
- Credenzas feature one set of doors on units up to 48" wide and two sets of doors on wider units.
- Credenza doors come standard with handles.
- Credenzas also feature a recessed 3" kickplate and one adjustable shelf per section.
- Executive Consoles are shipped knocked down. Specify Class 85 when obtaining freight quotes. If dimensions are required, use 10" for the height and add 3" to the depth and width of the table for packing materials.
- Modifications to the width, depth, height and the position of the modesty can be made.

Overhead Notes

- All overhead units 42" and wider have two sections. 36" units have one section.
- Overhead units feature 18" clearance between the worksurface and the bottom fascia.
- Overhead Storage Cabinets have hinged doors and 26" clearance between the shelves (20" if optional 24" clearance is specified). One adjustable shelf per section is included.
- Overhead Storage Units are drilled every 2¹/₂" for wire dividers. Units include 18-36 dividers, based on the width of the unit.
- Overhead Storage Units feature a 1³/₁₆" black cable management gasket positioned at the bottom of the back panel.
- Clearance between shelves is 12" on Overhead Storage Units with Retractable Doors, 14" without doors.
- Usable depth of bottom shelf on Overhead Storage Units with Retractable Doors is 12⁷/₈".
- Optional open-back units are open only below bottom shelf.
- Task lights and tackboards can be installed in lower area of overhead units.
- All overhead units are shipped fully assembled. Use Class 100 when obtaining freight quotes. If dimensions are required, add 3" to each dimension for packing materials.

Executive Series Consoles

24" Deep Space Saver without Shelf



MODEL #	WIDTH	HEIGHT	WEIGHT	PRICE
EMT242430	24 ³ / ₄	29 ¹ / ₂	76	449
EMT282430	28 ³ / ₄	29 ¹ / ₂	89	474
EMT302430	30	29 ¹ / ₂	90	498
EMT362430	36 ⁷ / ₁₆	29 ¹ / ₂	105	523
EMT422430	42 ⁷ / ₁₆	29 ¹ / ₂	114	581
EMT482430	48 ¹ / ₈	29 ¹ / ₂	123	615
EMT552430	56 ¹ / ₈	29 ¹ / ₂	137	647
EMT602430	59 ¹³ / ₁₆	29 ¹ / ₂	141	681
EMT692430	69 ¹³ / ₁₆	29 ¹ / ₂	155	729
EMT722430	71 ¹ / ₂	29 ¹ / ₂	159	748

30" Deep Space Saver without Shelf



MODEL #	WIDTH	HEIGHT	WEIGHT	PRICE
EMT243030	24 ³ / ₄	29 ¹ / ₂	88	509
EMT283030	28 ³ / ₄	29 ¹ / ₂	92	536
EMT303030	30	29 ¹ / ₂	96	565
EMT363030	36 ⁷ / ₁₆	29 ¹ / ₂	92	595
EMT423030	42 ⁷ / ₁₆	29 ¹ / ₂	100	629
EMT483030	48 ¹ / ₈	29 ¹ / ₂	107	665
EMT553030	56 ¹ / ₈	29 ¹ / ₂	119	701
EMT603030	59 ¹³ / ₁₆	29 ¹ / ₂	123	737
EMT693030	69 ¹³ / ₁₆	29 ¹ / ₂	135	790
EMT723030	71 ¹ / ₂	29 ¹ / ₂	142	809

Options

MODIFICATION	MODEL # CHANGE	PRICE
Full modesty panel	EMTwwdd30F	+112
Half right leg	EMTwwdd30HR	+56
Half left leg	EMTwwdd30HL	+56
Both half legs	EMTwwdd30HLHR	+112

24" Deep Space Saver with Shelf



MODEL #	WIDTH	HEIGHT	WEIGHT	PRICE
EMS362430	36 ⁷ / ₁₆	29 ¹ / ₂	123	818
EMS422430	42 ⁷ / ₁₆	29 ¹ / ₂	135	918
EMS482430	48 ¹ / ₈	29 ¹ / ₂	145	970
EMS552430	56 ¹ / ₈	29 ¹ / ₂	157	963
EMS602430	59 ¹³ / ₁₆	29 ¹ / ₂	169	1,004
EMS692430	69 ¹³ / ₁₆	29 ¹ / ₂	187	1,139
EMS722430	71 ¹ / ₂	29 ¹ / ₂	189	1,159

30" Deep Space Saver with Shelf



MODEL #	WIDTH	HEIGHT	WEIGHT	PRICE
EMT363030	36 ⁷ / ₁₆	29 ¹ / ₂	142	867
EMT423030	42 ⁷ / ₁₆	29 ¹ / ₂	156	965
EMT483030	48 ¹ / ₈	29 ¹ / ₂	169	1,027

30" Deep Space Saver with Shelf (cont.)

MODEL #	WIDTH	HEIGHT	WEIGHT	PRICE
EMT553030	56 ¹ / ₈	29 ¹ / ₂	183	1,034
EMT603030	59 ¹³ / ₁₆	29 ¹ / ₂	196	1,062
EMT663030	69 ¹³ / ₁₆	29 ¹ / ₂	217	1,201
EMT723030	71 ¹ / ₂	29 ¹ / ₂	219	1,220

Options

MODIFICATION	MODEL # CHANGE	PRICE
Sliding doors	EMSwwdd30S	+206

Corner Consoles



MODEL #	WIDTH	DEPTH	HEIGHT	WEIGHT	PRICE
For use with 24" d returns					
EMT4242FHCF	42	42	29 ¹ / ₂	140	987
For use with 30" d returns					
EMT4848FHCF	48	48	29 ¹ / ₂	160	1,145

For returns, order Executive Console with half-legs.

Counter Consoles



MODEL #	WIDTH	DEPTH	HEIGHT	WEIGHT	PRICE
EC483042	48	30	42	206	1,140
EC603042	60	30	42	231	1,255
EC483042	72	30	42	321	1,369

24" Deep Space Saver Credenza



MODEL #	WIDTH	HEIGHT	WEIGHT	PRICE
EMC362430	36 ⁷ / ₁₆	29 ¹ / ₂	184	1,440
EMC422430	42 ⁷ / ₁₆	29 ¹ / ₂	200	1,454
EMC482430	48 ¹ / ₈	29 ¹ / ₂	214	1,473
EMC552430	56 ¹ / ₈	29 ¹ / ₂	238	1,653
EMC602430	59 ¹³ / ₁₆	29 ¹ / ₂	246	1,675
EMC692430	69 ¹³ / ₁₆	29 ¹ / ₂	270	1,688
EMC722430	71 ¹ / ₂	29 ¹ / ₂	280	1,738

Add 'SL' to the end of the model number for pre-drilled mail slots at no upcharge. Contact Hamilton Sorter for modification charges for EMC consoles.

30" Deep Space Saver Credenza



MODEL #	WIDTH	HEIGHT	WEIGHT	PRICE
EMC363030	36 ⁷ / ₁₆	29 ¹ / ₂	210	1,487
EMC423030	42 ⁷ / ₁₆	29 ¹ / ₂	228	1,507
EMC483030	48 ¹ / ₈	29 ¹ / ₂	246	1,520
EMC553030	56 ¹ / ₈	29 ¹ / ₂	274	1,703
EMC603030	59 ¹³ / ₁₆	29 ¹ / ₂	282	1,727
EMC693030	69 ¹³ / ₁₆	29 ¹ / ₂	310	1,738
EMC723030	71 ¹ / ₂	29 ¹ / ₂	320	1,802

Add 'SL' to the end of the model number for pre-drilled mail slots at no upcharge. Contact Hamilton Sorter for modification charges for EMC consoles.

Overhead Storage Units with Hinged Doors

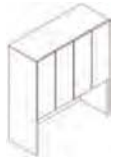
	MODEL #	WIDTH	DEPTH	WEIGHT	PRICE	
	MOHD36-18	36 ⁷ / ₁₆	16	150	963	
	MOHD42-18	42 ⁷ / ₁₆	16	175	1,066	
	MOHD48-18	48 ¹ / ₈	16	180	1,124	
	MOHD55-18	56 ¹ / ₈	16	185	1,179	
	MOHD42-18	MOHD60-18	59 ¹³ / ₁₆	16	190	1,237
	MOHD69-18	69 ¹³ / ₁₆	16	195	1,293	
	MOHD72-18	71 ¹ / ₂	16	200	1,353	

All overhead storage units with hinged doors are 48" high.

Options

MODIFICATION	MODEL # CHANGE	PRICE
24" clearance	MOHDww-24	None

Overhead Storage Units with no Doors

	MODEL #	WIDTH	DEPTH	WEIGHT	PRICE	
	MOND36CB	36 ⁷ / ₁₆	15	100	615	
	MOND42CB	42 ⁷ / ₁₆	15	110	639	
	MOND48CB	48 ¹ / ₈	15	120	663	
	MOND55CB	56 ¹ / ₈	15	135	697	
	MOND42CB	MOND60CB	59 ¹³ / ₁₆	15	140	739
	MOND69CB	69 ¹³ / ₁₆	15	155	774	
	MOND72CB	71 ¹ / ₂	15	160	816	

All overhead storage units with no doors are 36" high.

Overhead Storage Units w/ Retractable Doors

	MODEL #	WIDTH	DEPTH	WEIGHT	PRICE	
	MORD36CB	36 ⁷ / ₁₆	15	120	890	
	MORD42CB	42 ⁷ / ₁₆	15	131	921	
	MORD48CB	48 ¹ / ₈	15	142	956	
	MORD55CB	56 ¹ / ₈	15	159	1,006	
	MORD42CB	MORD60CB	59 ¹³ / ₁₆	15	165	1,017
	MORD69CB	69 ¹³ / ₁₆	15	182	1,066	
	MORD72CB	71 ¹ / ₂	15	187	1,130	

All overhead storage units with retractable doors are 36" high.

Options

MODIFICATION	MODEL # CHANGE	PRICE
No lower back	MOx DwwNB	None

Accessories

	MODEL #	DESCRIPTION	PRICE
	MRUSTL-24	24" black undersurface task light	140
	MRUSTLARM	Swivel-arm task light	234
	MRTBwwhh	Tackboard (per square foot)	24
	MCRSVD	MRSVD 12 Wire dividers	19

Two-Drawer Lateral Files

	MODEL #	WIDTH	HEIGHT	WEIGHT	PRICE
	MRLF262028	25 ⁵ / ₈	28	150	908
	MRLF262030	25 ⁵ / ₈	29 ¹ / ₂	154	938
	MRLF362028	36 ¹ / ₈	28	171	1,009
	MRLF362030	36 ¹ / ₈	29 ¹ / ₂	175	1,037

All lateral files have a depth of 20".

MRLF

Three-Drawer Lateral Files

	MODEL #	WIDTH	HEIGHT	WEIGHT	PRICE
	MRLF262043	25 ¹ / ₂	46 ¹ / ₂	190	1,285
	MRLF362043	36	46 ¹ / ₂	200	1,394

All lateral files have a depth of 20".

MRLF

Four-Drawer Lateral Files

	MODEL #	WIDTH	HEIGHT	WEIGHT	PRICE
	MRLF262060	25 ¹ / ₂	61 ¹ / ₂	234	1,392
	MRLF362060	36	61 ¹ / ₂	261	1,760

All lateral files have a depth of 20".

MRLF

Personal Files

	MODEL #	WIDTH	HEIGHT	WEIGHT	PRICE
	MLFMP282028L	28 ¹¹ / ₁₆	28	210	921
	MLFMP282028R	28 ¹¹ / ₁₆	28	210	921

All lateral files have a depth of 18¹/₂".

MLFMP

Undertable Accessories

	MODEL #	WIDTH	DEPTH	HEIGHT	WEIGHT	PRICE
	Pencil Drawer					
	MRDR16-3-20	20	17 ¹ / ₈	2 ⁷ / ₈	15	166
MRDL16-27	Two-Drawer Suspended Pedestal					
	MRML16-S	15 ⁹ / ₁₆	17 ¹³ / ₁₆	18 ¹ / ₂	70	456
MRDL16-29	Two-Drawer Pedestal					
	MRDL16-29	15 ¹³ / ₁₆	18 ³ / ₄	28	90	759
MRTL16-29	Three-Drawer Pedestal					
	MRTL16-29	15 ¹³ / ₁₆	18 ³ / ₄	28	85	759
MRTL16-29	Two-Drawer Pedestal with Casters					
	MRDL16-29-C	15 ¹³ / ₁₆	18 ³ / ₄	28	85	818
MRTL16-29	Three-Drawer Pedestal with Casters					
	MRTL16-29-C	15 ¹³ / ₁₆	18 ³ / ₄	28	90	818

Bookcases



MBC

MODEL #	WIDTH	HEIGHT	SHELVES	WEIGHT	PRICE
MBC301830	30	30	1	94	593
MBC361830	36	30	1	108	635
MBC301836	30	36	2	105	663
MBC361836	36	36	2	121	706
MBC301842	30	42	2	127	797
MBC361842	36	42	2	146	847
MBC301860	30	60	3	148	936
MBC361860	36	60	3	171	985
MBC301872	30	72	4	181	1,069
MBC361872	36	72	4	208	1,127

All bookcases have a depth of 18. Shelves are 16" deep to accommodate binder and printout storage.

Executive Series Mail Stations

How to Specify Your Options

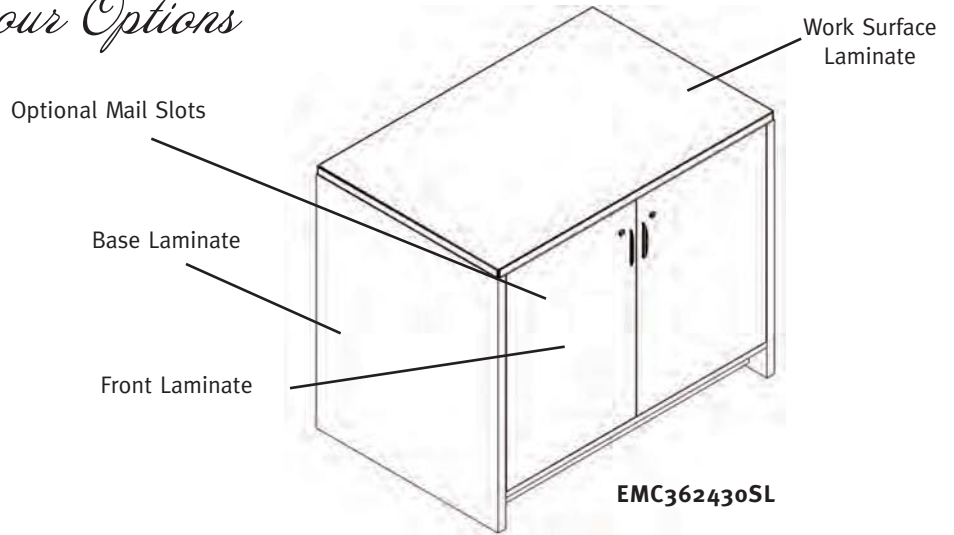

EXECUTIVE CREDENZA

Locks		
Model	Increase	Description
.....	\$0locks

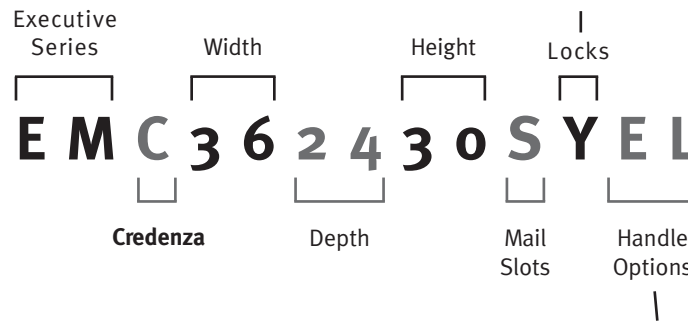

Handles*		
Model	Increase	Description
EL	\$0	Elliptical
CB	\$0	Crescent Black
CS	\$0	Crescent Silver
TC	\$0	Textured Crescent
FC	\$0	Flared Crescent
WP	\$0	Wired Pull (MR Zinc)
SP	\$0	Special Handle

*Recessed handle is not an option

See page 60 for color codes.

Notes

- Executive Mail Stations are light-use equipment with no aluminum extrusions and are not intended for general mail center use.
- Modules attach to consoles with double-faced adhesive tape.
- Consoles feature one set of doors on units up to 48" wide and two sets of doors on wider units.
- Consoles doors come standard with black handles and a 1 1/2" x 10" mail slot
- Consoles also features a recessed 3" kickplate and one adjustable shelf per section.
- Executive Mail Station consoles are shipped assembled. Specify Class 100 when obtaining freight quotes. If dimensions are required, use 10" for the height and add 3" to the depth and width of the console for packing materials. See page 5 for module freight quote information.

*Executive Mail Stations***24" Deep Space Saver Credenza**

EMC362430

MODEL #	WIDTH	HEIGHT	WEIGHT	PRICE
EMC362430SL	36 ^{7/16}	29 ^{1/2}	184	1,440
EMC422430SL	42 ^{7/16}	29 ^{1/2}	200	1,454
EMC482430SL	48 ^{1/8}	29 ^{1/2}	214	1,473
EMC552430SL	56 ^{1/8}	29 ^{1/2}	238	1,653
EMC602430SL	59 ^{13/16}	29 ^{1/2}	246	1,675
EMC692430SL	69 ^{13/16}	29 ^{1/2}	270	1,688
EMC722430SL	71 ^{1/2}	29 ^{1/2}	280	1,738

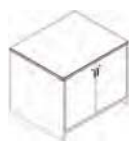
30" Deep Space Saver Credenza

EMC363030SL

MODEL #	WIDTH	HEIGHT	WEIGHT	PRICE
EMC363030SL	36 ^{7/16}	29 ^{1/2}	210	1,487
EMC423030SL	42 ^{7/16}	29 ^{1/2}	228	1,507
EMC483030SL	48 ^{1/8}	29 ^{1/2}	246	1,520
EMC553030SL	56 ^{1/8}	29 ^{1/2}	274	1,703
EMC603030SL	59 ^{13/16}	29 ^{1/2}	282	1,727
EMC693030SL	69 ^{13/16}	29 ^{1/2}	310	1,738
EMC723030SL	71 ^{1/2}	29 ^{1/2}	320	1,802

SL, mail slot option, is a non-contract option available at no additional charge. Price reflects console with mail slot only.

Cable Management

MRCBLR

MODEL #	DESCRIPTION	PRICE
MRCBLR-36	Cable raceway for 36" w console	37
MRCBLR-48	Cable raceway for 48" w console	50
MRCBLR-60	Cable raceway for 60" w console	61
MRCBLR-72	Cable raceway for 72" w console	75
MRCBLCO-3	3 ^{1/4} diameter cable cutout	20

Electrical Options

MRRPC-3

MODEL #	DESCRIPTION	PRICE
MRMOPS-SP-6	6-outlet power strip 12"	70
MRRPC-3	Retractable power center	182

Carts

Platform Cart*

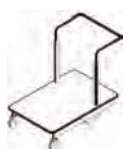

MODEL #	WIDTH	DEPTH	HEIGHT	WEIGHT	PRICE
UC3725P	37	25	36-42	75	1,019

Cart includes cart frame, adjustable padded handle, lower platform with scuff-resistant bumper, two straight and two swivel wheels.

UC3725P

Delivery Cart*



MODEL #	WIDTH	DEPTH	HEIGHT	WEIGHT	PRICE
UC3725D	37	25	36-42	85	1,343

Cart includes cart frame, adjustable padded handle, lower platform with scuff-resistant bumper, two straight and two swivel wheels, adjustable bracket, small parcel and small mail baskets.

UC3725D

Master Cart*



MODEL #	WIDTH	DEPTH	HEIGHT	WEIGHT	PRICE
UC3725M	37	25	36-42	90	1,413

Cart includes cart frame, adjustable padded handle, lower platform with scuff-resistant bumper, two straight and two swivel wheels, adjustable bracket, large parcel and large mail baskets.

UC3725M

Executive Cart*



MODEL #	WIDTH	DEPTH	HEIGHT	WEIGHT	PRICE
UC3825E	37	25	36-42	100	1,689

Cart includes cart frame, adjustable padded handle, upper platform with scuff-resistant bumper, two straight and two swivel wheels, adjustable bracket, small parcel and small mail baskets with writing surface and mailbag grips.

UC3825E

Cart Accessories



UC172507PB

MODEL #	WIDTH	DEPTH	HEIGHT	WEIGHT	PRICE
Small Parcel Basket					
UC172507PB	17	25	7	9	114
Small Mail Basket					
UC172511MB	17	25	11	10	133
Large Parcel Basket					
UC173607PB	17	36	7	10	144
Large Mail Basket					
UC173611MB	17	36	11	11	169
Writing Platform					
UC2208WP	21 ³ / ₄	8		10	65
Upper Platform					
UC2821UP	28	21		20	198
Mailbag Grips (Set of Two)					
UCMG				5	106
Adjustable Bracket					
UCADJB				8	101

*The Universal Cart provides flexibility in configuring components to customer's mail distribution needs. The cart frame is one piece welded construction, powder-coated on two 8" wheels and two 5" swivel casters. Wheels and casters are non-marking rubber inset to eliminate scuffing of walls and furniture. The base unit is a single-tier platform cart to which additional platforms, mail and parcel baskets and accessories may be added. The base unit has a padded, height-adjustable handle (36" to 42" in 2" increments). Platforms are edged in scuff-resistant bumper molding.

Upper platforms, mail and parcel basket assemblies are adjustable on 2" centers. The 8" x 21³/₄" writing surface snaps to handle. Rubber-insulated mailbag grips attach to handle.

Mail baskets are 11"h x 17"w and are available in 25" or 36" depths.

Parcel baskets are 7¹/₄"h x 17"w and are available in 25" or 36" depths.

Laminates

Standard Colors

COLOR NAME	NUMBER	WORK SURFACE	BASE AND VERTICALS	EDGE BANDING	THERMOFOIL	BRAND NAME & NUMBER
Frosty White	071	◆	◆	◆	◆	Wilsonart 1573-60
Designer White	082	◆	◆	◆	◆	Wilsonart 0354-60
Antique White	013	◆	◆	◆	◆	Wilsonart 1572-60
Natural Almond	031	◆	◆	◆	◆	Wilsonart D30-60
Grey Moss	090	◆	◆	◆		Wilsonart 15008
Fashion Grey	035	◆	◆	◆	◆	Wilsonart D381-60
Dove Grey	002	◆	◆	◆	◆	Wilsonart D92-60
Slate Grey	068	◆	◆	◆		Wilsonart D91-60
Shadow	096	◆	◆	◆		Wilsonart D96-60
Ingot Grey	006	◆	◆	◆		Pionite SG211-S
Black	007	◆	◆	◆	◆	Wilsonart 1595-60
Graphite Nebula	030	◆	◆	◆		Wilsonart 4623-60
Canyon Zephyr	093	◆	◆	◆		Wilsonart 4842-60
Kensington Maple	036	◆	◆	◆	◆	Wilsonart 10776-60
Solar Oak	089	◆	◆	◆	◆	Wilsonart 7816-60
Monticello Maple	101	◆	◆	◆	◆	Wilsonart 7925
Oiled Cherry	055	◆	◆	◆	◆	Pionite WC421-S
Empire Mahogany	078	◆	◆	◆		Wilsonart 7122T-60
Windsor Mahogany	001	◆	◆	◆		Wilsonart 7039-60
Woodlawn Cherry	003	◆	◆	◆	◆	Casco H1209
Cognac	091	◆	◆	◆	◆	Nevamar Dynea 4511
Shaker Cherry	097	◆	◆	◆	◆	Wilsonart 7935-7
Columbian Walnut	102	◆	◆	◆		Wilsonart 7943K
Cafelle	099	◆	◆	◆		Wilsonart 7933T-07

These laminate colors are available at standard prices. Special laminates available from 5% to 30% increase and up. Call for pricing.

Designer Worksurface Colors

COLOR NAME	NUMBER	WORK SURFACE	BASE AND VERTICALS	EDGE BANDING	BRAND NAME & NUMBER
White Nebula	086	◆		◆	Wilsonart 4621-60
Desert Zephyr	095	◆		◆	Wilsonart 4841-60
Twilight Zephyr	092	◆		◆	Wilsonart 4845-60
Misted Zephyr	094	◆		◆	Wilsonart 4843-60

These laminate colors are available only for work surfaces at standard prices. Special laminates for work surfaces available from 5% to 15% increase and up. Call for pricing.

GREENGUARD® Children & Schools Certified

Achieve LEED® Credits With Hamilton Sorter Products

All Hamilton Sorter products are GREENGUARD Children & Schools Certified. Our products are made from an Environmentally Preferable Product (EPP) which contains 100% recycled and recovered wood waste or fiber generated from wood residue, including sawdust and shavings (100% pre-consumer).

Hamilton Sorter products meet and exceed the following requirements for LEED-CI (commercial interiors) and LEED for Schools and are applicable to tenant improvement of new or existing office space and could help you achieve the following credits on your project.

Materials and Resource	LEED Requirements	Credit
4.1 RECYCLED CONTENT, 10% (POST-CONSUMER + 1/2 PRE-CONSUMER)	Sum of post-consumer recycled content plus 1/2 of the pre-consumer content constitutes at least 10% (based on cost) of the total value of the materials in the project.	1 POINT
4.2 RECYCLED CONTENT, 20% POST-CONSUMER + 1/2 PRE-CONSUMER)	Sum of post-consumer recycled content plus 1/2 of the pre-consumer content constitutes an additional 10% beyond MR Credit 4.1 (total of 20%, based on cost) of the total value of the materials in the project.	1 POINT IN ADDITION TO MR CREDIT 4.1
4.5 LOW-EMITTING MATERIALS, SYSTEMS FURNITURE AND SEATING	GREENGUARD Indoor Air Quality Certified	1 POINT

Depending on your project's location, Hamilton products may be able to contribute to these additional points.

5.1 REGIONAL MATERIALS, 10% MANUFACTURED REGIONALLY	Building materials or products that have been extracted, harvested or recovered, as well as manufactured, within 500 miles of the project site for a minimum of 10% (based on cost of the total materials value).	1 POINT
5.2 REGIONAL MATERIALS, 20% MANUFACTURED REGIONALLY	Building materials or products that have been extracted, harvested or recovered, as well as manufactured, within 500 miles of the project site for an additional 10% beyond MR credit 5.1 (total of 20% based on cost) of the total materials.	1 POINT IN ADDITION TO MR CREDIT 5.1

Source: LEED® — NC Green Building Rating System For New Construction & Major Renovations: Version 2.2. Every reasonable effort was made to present current and accurate information. Please consult the U.S. Green Building Council for further details on LEED® (www.usgbc.org).

Green

Hamilton Sorter's Commitment to the Environment

We recognize our responsibility in maintaining and improving our environment. Through the use of recycled materials used to produce our products to our waste reduction programs, our company is continually improving our methods in the use and disposal of material.

- ◆ We use Particleboard and MDF which are fabricated from recycled wood waste material or fiber generated from wood residue left behind by lumber harvesting and processing.
- ◆ The cardboard packaging material utilized is made from recycled material.
- ◆ Unusable pallets are recycled.
- ◆ We work with customers to reduce the amount of packaging materials required for shipping.
- ◆ All Aluminum scrap is recycled.
- ◆ Adhesives used when laminating are a water-based alternate to solvent-based adhesives.
- ◆ Products meeting low VOC emissions are utilized.
- ◆ Powder coat paint is used on all metal surfaces which is waste free and does not require solvents.

We are pleased to announce that the GREENGUARD Environmental Institute has recognized Hamilton Sorter's conservation efforts. We have received GREENGUARD's Children and School Product Certification for low emitting products and materials under the standards of the Institute. Hamilton Sorter also has its' product tested every quarter to verify that it meets these standards.